



d-fence ^{6th} SENSE

Electronic invisible fence
User Guide

ISIT[®]
INTERFERENCE SIGNAL INTENSITY TEST

Declaration of Conformity

We:

VNT electronics s.r.o.
Dvorská 605
563 01 Lanškroun
IČO: 64793826

declares under own responsibility that the product:

Electronic invisible fence

Dogtrace d-fence

is in compliance with essential requirements and other relevant provisions of Directive 2014/53/EC meets requirements of General Licence of The Czech Telecommunication Office according to general licence no. VO-R/10/05.2014-3, and corresponds to the following standards:

ETSI EN 301 489-1 V1.9.2

ETSI EN 301 489-3 V1.6.1

ETSI EN 300 220-2 V.2.4.1

**ETSI EN 60950-1 ed.2:2006 /A1:2010 /A11:2009 /A12:2011 /A2:2014/Cor.1:2012
EN 62479:2010**



The product is safe under conditions of standard use in accordance with the user guide. The Declaration of Conformity is based on following date:

Measuring report no.: 3606/05 issued by certificated laboratory no. 1104.3 ITC Uherské Hradiště

This declaration of Conformity is created in exclusive responsibility of producer. In Litomyšl 28.8.2014

Ing. Jan Horák
executive director
Tel.: +420 733 121 890
info@dogtrace.com
www.dogtrace.com

Thank you for purchasing the product **Dogtrace d-fence** from VNT electronics s.r.o., Czech Republic.

Please read this user guide before operating your device, and keep it for future reference.

Hereby, **VNT electronics s.r.o.** declares that this **Dogtrace d-fence** is in compliance with the essential requirements and other relevant provisions of Directive 2014/53/EC.

Table of contents

Table of contents	3
Introduction	3
Features	3
Package contents	4
Optional accessories	4
How the d-fence works	5
Transmitter unit	6
Receiver settings	8
Antenna wire installation	11
Transmitter unit settings	14
Training method	19
Tips and information	19
Technical specifications	24
Warranty terms and conditions	25
Installation drawing	26
Wall-mount screw hole template	27
Certificate of warranty	28

Introduction

The electronic invisible fence **d-fence**, consisting of the transmitter unit, the antenna wire and the receiver attached to a collar worn by the dog, is a modern, safe, reliable, and highly effective system enabling you to define the boundaries of a safe play area for your dog (such as your garden) without the risk of escaping. The antenna wire carries a signal generated by the transmitter unit. If your dog, wearing a receiver collar, approaches the antenna wire, the receiver starts to emit warning beep sounds (warning zone) followed by stimulation impulses together with the beep sounds (correction zone). It is possible to easily adjust the width of both zones and the intensity of the stimulation. Thanks to the ergonomic design and low weight of the receiver, it is suitable for all dog breeds and sizes.

Features

- Modern design and backlit LCD.
- A rechargeable, back-up battery pack is able to provide up to sixteen hours of run time for the transmitter unit during a power outage.
- Both zones are independent of each other making it possible to set either the warning zone or the correction zone.
- Multilingual menu.
- Ongoing measuring and testing of the antenna wire, signalisation of wire breakage.

- Waterproof receiver.
- Receiver battery life up to six months.
- Non-contact magnetic switch for changing the receiver modes.
- Eight levels of stimulation impulse.
- Function ISIT - Interference Signal Intensity Test.
- For safety reasons the **d-fence** receiver stops emitting stimulation impulses when the dog remains in the correction zone for more than ten seconds.

Package contents

- Transmitter unit
- Receiver with a collar strap
- 2 pairs of contact points (12 mm and 17 mm)
- CR2 3V lithium battery
- Back-Up battery pack 9,6V
- Magnet with a neck strap
- Power supply adapter
- Test discharge lamp
- Antenna connector
- 2 splice wire connectors
- 2 wall plugs
- 2 twin fast screws
- 100 m insulated wire 0,75 mm² (not included in d-fence 202 set)
- User guide (with certificate of warranty)
- Instructional DVD

Optional accessories

- Additional receiver
- Dummy receiver
- Woven or plastic collars - various colours
- Spare contact points (12 mm, 17 mm, 21 mm)
- Spare CR2 3V lithium battery
- Spare back-up battery pack 9,6V
- 100 m insulated wire 0,75 mm²; 1 mm²; 1,5 mm²; 2,5 mm²
- Splice wire connectors
- Plastic boundary flags
- Spare magnet
- Antenna connector
- Spare rubber seal
- Spare screws

How the d-fence works

- The electronic invisible system **d-fence** consisting of the transmitter unit, the antenna wire and the receiver attached to a collar worn by the dog will help you to define the boundaries of a safe play area for your dog (such as your garden) without the risk of escaping.
- The antenna wire placed on the ground, buried or attached to an existing fence, carries a signal generated by the transmitter unit. If your dog, wearing a receiver collar, approaches the antenna wire, the receiver starts to emit warning beep sounds (warning zone).
- If the dog moves forward towards the antenna wire, the receiver emits stimulation impulses together with the beep sounds (correction zone).
- The width of the warning and the correction zone can be set easily on the transmitter unit. Both zones have range settings from 0 to minimum 7 m.
- Both zones are independent of each other making it possible to set either the warning zone or the correction zone.
- Your dog will quickly learn to move only in the free area inside the boundaries.
- To increase efficiency, it is recommended to use a visual barrier during training for electronic invisible fence system until the animal has learned the boundary.
- An unlimited number of receiver collars can be used with one transmitter unit. It is possible to keep as many dogs as you wish safely in the same area.
- The voltage within the antenna wire does not exceed 12V so there are no risks to health and safety of persons or animals even if the antenna wire is interrupted.
- System d-fence consists of safety features, which protect your dog and device when unusual situations occurs. (see Safety features on page 20)

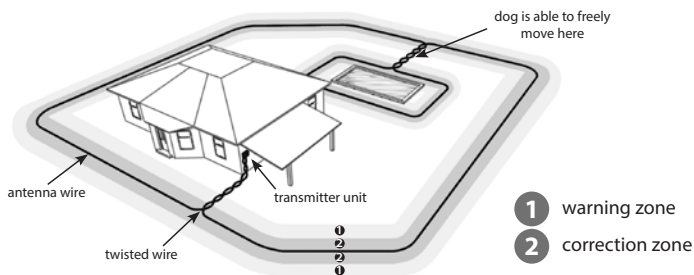



Transmitter unit

Description



1 - Backlit graphic LCD 2 - Touch panel control 3 - Antenna wire connector 4 - Power supply adapter connector

Buttons function

-  – this button switches on and off the transmitter unit.
- **MENU** – this button displays the main menu.
- **BACK** – this button performs a step back.
- **ENTER** – this button activates the currently selected menu item.
-  /  – these arrow buttons navigate up and down through menu items and adjust the zones values.

Back-up battery pack insertion

A rechargeable, back-up battery pack is provided to supply power during a power outage. The back-up battery pack will provide up to sixteen hours of run time for the transmitter unit (see the section *Back-Up Battery Power Indicator*). The run time depends on the length of the antenna wire and on the widths of the zones.

- Remove the battery cover on the back of the transmitter unit.
- Attach the connector from the back-up battery pack to the socket inside the battery compartment and then put the back-up battery pack into the compartment.

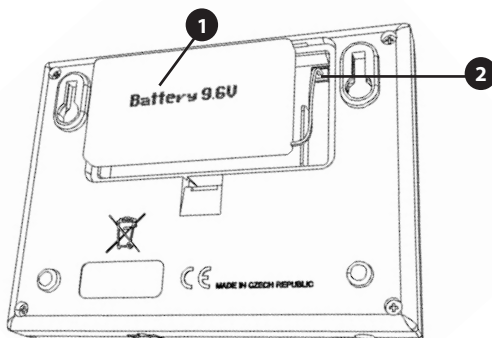

1 - Back-up battery pack 9.6V 2 - Socket for the back-up battery pack

Important: It is not possible to switch on the transmitter unit if powered by the back-up battery pack only. To switch on the transmitter unit the power adapter must be plugged into the power outlet.

Transmitter unit installation

- Place the transmitter unit in a dry place or use a waterproof housing, water can cause irreversible damage to your transmitter unit.
- The transmitter unit needs to be placed near a power source.
- Plug the adapter into the power outlet and connect it to the transmitter unit.

Receiver settings

Description

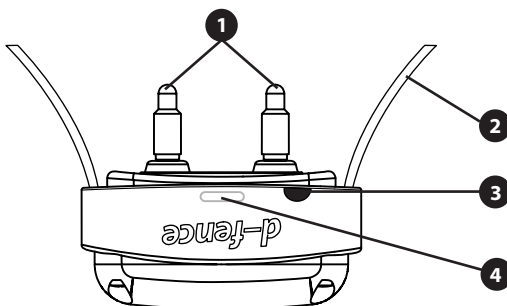

1 - Contact points 2 - Strap 3 - Target 4 - LED indicator

Battery insertion and replacement

- Unscrew the 4 screws of the top of the receiver using a cross-head screwdriver and remove the lid. Insert the 3V lithium CR2 battery into the battery compartment. Please check that the battery is installed with correct polarity (according to the polarity marks inside the battery compartment - see the picture). Wrong polarity may damage the unit.
- Approximately after a second, the receiver will beep if the battery is inserted correctly. Before putting the lid of the receiver back in place, make sure that the rubber seal is correctly seated in its groove. Lubricating the seal with a thin layer of silicone grease will increase its lifespan.
- Screw down the 4 screws of the top tightly (do not over tighten them).

Battery polarity marks

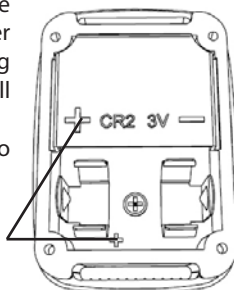

Checking the battery power

LED indicator situated on the receiver's front cover under the sign "d-fence" indicates the status of the battery. Red light indicates low battery. Prepare a spare 3V lithium battery CR2 and follow the instructions described in the section *Battery insertion and replacement*.

Stimulation impulse setting

The **d-fence** receiver is activated as soon as the dog wearing the collar enters the prohibited zone, the receiver starts to emit warning beep sounds. If the dog continues to move forward towards the antenna wire the collar emits stimulation impulses. There are 9 modes available on the receiver - 8 stimulation levels and ISIT function (mode 9). We recommend to start with the low level (mode 1) and increase it gradually to define the stimulation level at which the dog reacts.

The supplied magnet allows you to adjust the stimulation impulse level.

- The receiver must be switched on (battery is inserted).
- Place the magnet to a target marked on the receiver.
- The receiver starts to beep. The number of emitted beeps in the sequence indicates the mode (1-9).
- When setting the mode 9 (ISIT function), different beep tone is emitted.
- After the required mode is set, move the magnet away from the receiver.
- The mode configuration is saved.

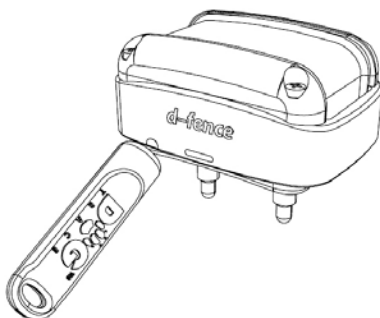

The following table shows different modes of the receiver. The intensity level of stimulation impulse must be set according to the size, sensitivity and reaction of each dog.

Mode	Number of beeps	Stimulation impulse level
1	1	low
2	2	
3	3	
4	4	
5	5	
6	6	
7	7	
8	8	
9	9	ISIT function

Note: The receiver is set in mode 1 by default.

Choosing the contact points

The stimulation is delivered through the receiver contact points. Two different series of contact points are supplied. The length of the contact points must be sufficient to have proper contact with the dog's skin, enabling the device to operate correctly. If you have a short-haired dog use the short 12 mm contact points, if you have a long-haired dog replace them with the longer 17 mm contact points supplied with the kit. Before installing contact points, take out the battery from receiver or turn off the transmitter unit. Carefully tighten them manually (do not use a key).

Note: It is possible to purchase 21 mm long contact pints for long-haired dogs.

Antenna wire installation

Antenna wire must create an uninterrupted loop starting and ending at the transmitter unit. Before you start with the antenna wire installation it might be useful to sketch a rough map of your property showing the wire installation and places of antenna wires connection.

Antenna wire sample layouts:

Leading an even number of wires close together reduces the range of zones (see Figure - gray rim), by twisting the wires around each other the signal is completely cancelled. Minimum distance 1,5 m is tentative with regards to the size of the set zones.

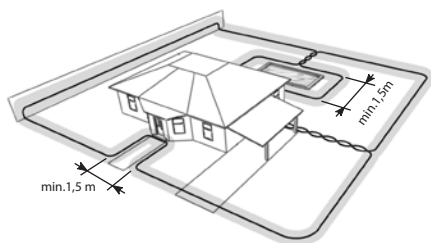

Type 1:
Land borders including prohibited area (eg.: pool, walkway).

Type 2: Land borders with preservation of the free passage.

The combination of wire route on the ground and on the existing fence.

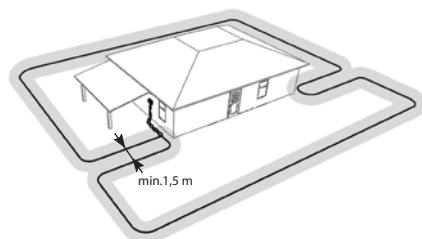
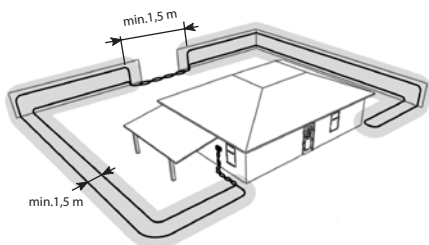

Type 3: Separation of the garden into 2 parts within one loop installation.

Separation of garden is possible also by installation of two parallel loops from one transmitter unit.

Beware: In the second case, when interruption of one loop occurs the fault on the transmitter unit will not show.

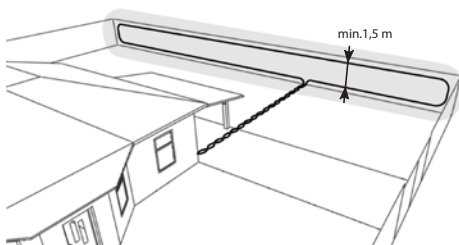

Type 4:

Setting the boundary on one or more sites of the garden. The wire runs along the border of the prohibited area and returns back about 1,5 m from the top/ bottom/ front or beyond the boundary according to the possibilities.

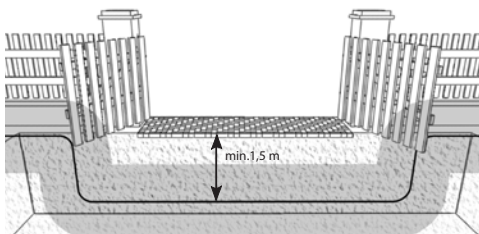

Type 5:

Creation of the free passage for the dog in a simple wiring by installing wire under / above the ground. The minimum distance from a passage way is circa 1,5 m in all directions with regards to the zone setting.

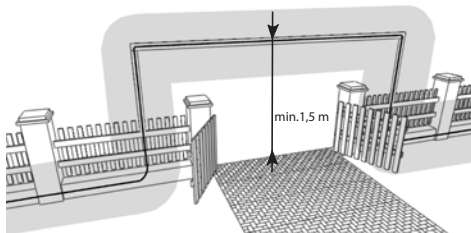

Installation

- Lay the wire along your proposed boundary creating a loop. The antenna wire can be placed on the ground, under the ground, on a fence or a wall in such case it is recommended to install the wire about 30 cm above the ground or as high as where the dog wears the receiver).
- According to the length of the antenna wire installation it is possible to use wire of cross-section 0,75 mm²; 1 mm²; 1,5 mm² or 2,5 mm² (see the section Technical data).
- The antenna wire should not be stretched tight, wire length changes due to a temperature changes.
- To connect antenna wires, use the splice wire connectors. Firmly apply pressure with the pliers to snap the top and bottom of the splice connector together. It is recommended to use an electrical tape to ensure connections are adequately insulated.
- The signal can be disturbed by twisting the wires together. This is useful when running the wire between the boundaries and the transmitter unit, which will allow the dog to cross without generating a signal.
- Create round corners; antenna wire should turn corners gradually, avoiding sharp right angle turns.
- The two opposite wires need to be separated by a minimum of 1,5 m to avoid the signals interfering with each other.
- Strip the insulation off the ends of the wire and attach them into the antenna connector. Plug the antenna connector into the socket on the bottom of the transmitter unit.

Checking the area before antenna wire installation - ISIT function

The ISIT function - Interference Signal Intensity Test - will measure the intensity of the interference signal in the area where you plan to install the wire. In the ISIT mode (mode 9), a red LED indicator will blink when an interference signal is detected and its frequency will increase as the interference signal becomes stronger. When the interference signal reaches a maximum value, the red LED will stop blinking and remain lit. The antenna wire needs to be positioned away from other sources of potential interference to maintain the integrity of the system. If routing the antenna wire close to electrical cables avoid parallel running. It is best to cross the cables at right angles to localise any signal interruption to the point of crossing only.



Tip: It is recommended to create a short testing loop (e.g. 2 m) to test the correct function of the system in places where you plan to install the antenna wire and where the receiver detected an interfering signal.

Plastic boundary flags (Optional accessories)

The plastic boundary flags are a temporary visual aid for your dog during training, and will be removed once your dog is familiar with the boundaries. The plastic boundary flags enable your dog to visualize the area where he can move freely and the boundaries he must not cross. It is recommended to place the marks at the inner edge of the acoustic warning zone close enough to each other.

Transmitter unit settings

Language selection





- Switch on the transmitter unit by pressing the  button. The power adapter must be always plugged into the power outlet and connected to the transmitter unit while switching on. It is not possible to start the transmitter unit while being powered only by the back-up battery pack.
- The first time the transmitter unit is switched on a language menu appears on the screen.
- Select the appropriate language from the menu, press **ENTER** to confirm the selection.
- Pressing the **MENU** button accesses the Main menu.



Setting up the transmitter unit for a short or a long installation of an antenna wire.

d-fence 6th SENSE - 2nd generation enables you to switch over the transmitter unit power, which is generated into the antenna wire. This function allows a fine setting of warning and correction zone for a short installation (up to 400 m wire installation) and also for a long installation (above 400 m wire installation). The newly purchased transmitter unit is factory pre-set for the installation up to 400 m. When your installation is longer, it is necessary to make the following settings.

Setting process:

- Press **MENU** to enter the Main menu, by pressing / buttons select Configuration, press **ENTER** to confirm your settings.
- By pressing **ENTER** button choose Loop.
- If your antenna wire installation is shorter than 400 m, select by pressing / buttons **UP TO 400 m**. If your antenna wire installation is longer than 400 m, select **OVER 400 m**.
- Use **MENU** button to return to the Main menu.

Important: In the Main menu – Zones settings – is the current setting indicated by:



- installation up to 400 m



- installation over 400 m

Important: The loop of the transmitter unit needs to be calibrated after each adjustment of the antenna wire installation length.

Calibration of the loop:





- In the Main menu, select Measuring.
- **Disconnect the antenna connector with the installed loop** (antenna wire).
- Press **ENTER**.
- **Check that you have disconnected the antenna connector from the transmitter unit.**
- Press **ENTER**.
- In the bottom line you will see a confirmation „Calibration successful!“

- Now you can plug in the antenna connector with an antenna loop into the antenna socket transmitter unit.

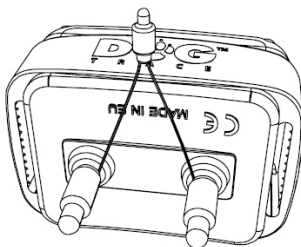
Zones settings

The width of the warning and the correction zone can be set easily on the transmitter unit. Both zones are independent of each other making it possible to set either the warning zone or the correction zone. Both zones have range settings from 0 to a minimum 7 m. Maximum width depends on the length and the cross section of the antenna wire. We recommend the use of the test discharge lamp to set the zones width. Place the test discharge lamp in contact with each of the contact points as shown in the picture (before doing so, make sure that the device is not active - remove the battery from the receiver or switch the transmitter unit off).



- Insert the battery into the receiver and switch the transmitter unit on by pressing the  button.
- Set the receiver in the mode 1 - 8 (see the section Stimulation Impulse Setting)
- From Main menu select Zones Settings. If the antenna wire is incorrectly connected or interrupted, the unit will beep and  symbol will be displayed on the screen.
- The widths of warning and correction zone are set by default to value 0.
- Pressing **ENTER** in the Zones Settings menu moves the focus on the screen to the Warning zone setting.
- Select the distance where you want to define the boundary of the **warning zone**, hold the receiver with the sign "d-fence" towards the antenna wire about 30 cm above the ground or as high as where the dog wears the receiver. Adjust the zone setting (0 - 600) on the transmitter unit by pressing the / buttons until the receiver emits a warning sound signals.
- Press **ENTER** to confirm your settings and to move focus to Correction zone setting.
- Select the distance where you want to define the boundary of the **correction zone**, hold the receiver with the sign "d-fence" towards the

antenna wire about 30 cm above the ground or as high as where the dog wears the receiver. Adjust the zone setting (0 - 600) on the transmitter unit by pressing the \wedge / \vee buttons until the receiver emits stimulation impulses together with the sound signals at approximately one second intervals. The stimulation impulses are indicated by the test discharge lamp.

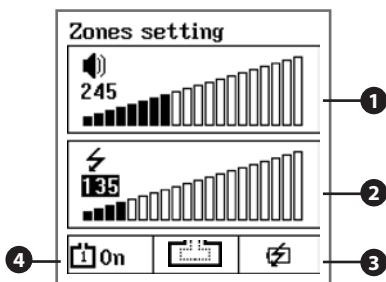

Important: The maximum widths of the zones vary depending on the length of the antenna wire laid out on the property. The longer the antenna wire, the narrower the zones. It is very important the dog wears the receiver with the sign "d-fence" towards the antenna wire so the sign is visible. This is important for the correct function of the receiver.



1 - Warning zone setting 2 - Correction zone setting
3 - Back-up battery pack power indicator 4 - Antenna wire indicator

Back-up battery power indicator

The back-up battery indicator (at the right bottom corner of the screen) displays the status of the back-up battery pack in four stages.

-  - Transmitter unit is connected to power outlet (the back-up battery pack is charging).
-  - Transmitter unit is powered by the back-up battery pack - the back-up battery pack is fully charged.
-  - Transmitter unit is powered by the back-up battery pack - the back-up battery pack is low.

Antenna wire indicator

The antenna wire indicator at the left bottom corner of the screen displays the status of the antenna wire.



On – Antenna wire is connected and uninterrupted.



X – Antenna wire is disconnected, interrupted or transmitter unit calibration was performed by mistake while antenna wire connected.

Other transmitter unit functions

- **Faults** – Select **Faults** in the **Main** menu to display the current status of the installed loop.
- **Measuring** – The menu item **Measuring** contains useful service information. It is also possible to calibrate a transmitter as required for the correct loop measurement. The device is already factory calibrated and the recalibration is necessary only in exceptional cases after the service agreement (in menu **Measuring**, press **ENTER** button, disconnect the antenna connector with the loop, press **ENTER** again and reconnect the antenna connector to the socket). Never calibrate when the antenna connector is connected.
- **Configuration** – In menu **Configuration**, press **ENTER** to set the display contrast (0 – 20).
- **Quick start guide** – Brief instruction and guide for installation.
- **Display backlight** – Turns off automatically after more than 40 seconds of inactivity. Reactivate the display backlight by pressing any button.

Training method

Getting started with the electronic invisible training fence

You can use the device with a six month old puppy that has already completed the basic training. It is not recommended to use the device with dogs that are not in a good physical condition (e.g. heart problems, epilepsy, etc.), pregnant or nursing bitches and dogs who have behaviour disorders. Do not use d-fence for dogs that cannot respond appropriately due to injury, illness, senility or age. Your dog will have to get used to a collar with a receiver. Let the dog wear a collar for a few days without using it.

Be patient

While acquainting your dog with a newly installed invisible fence, proceed slowly step by step to get your dog to establish a link between its bad behaviour (e.g. escaping) and subsequent correction. Make your dog familiar with boundaries of warning and correction zone. Mark the warning zone with plastic boundary flags (or other marks) to define clearly the forbidden area and help your dog to visualize the delimited area boundaries.

Commend your dog for good behaviour

Once your dog learns to respond correctly to a warning beep sound and leaves the warning zone, your dog should be commended for its good behaviour. This way, the dog understands the principle of the newly delimited area quicker.

Tips and information

Getting the best results

- It is very important the dog wears the receiver with the sign "**d-fence**" towards the antenna wire so the sign is visible.
- The receiver needs to be very snug around the dog's neck to work properly. A loose fit can allow the receiver to move around on the dog's neck. The collar must be just tight enough to allow the contact points to make good contact with your dog's skin. You may need to trim the hair in the area of the contact with the skin or switch to the longer contact points to ensure consistent contact. This can directly affect the

performance of the collar unit and whether or not the dog will receive the stimulation impulses. A loose collar can also result in skin irritations. The collar should be tight enough to fit two fingers between the collar and your dog's neck, but not so tight that it restricts your dog's breathing.

- It is possible to check the current mode of the receiver. Place the magnet to a target marked on the receiver. Remove it after one second. The receiver emits certain number of beeps indicating the current mode (1-9).
- It is possible to check that your invisible fence system is operating correctly any time using the test discharge lamp (see the section *Zones setting*).
- Check the condition of the receiver battery regularly. Low battery can affect correct operation of the system.
- Before each use make sure the contact points are properly tighten (by hand).
- Do not install the antenna wire near the electrical cable, telephone cable or television cable. If necessary to place the antenna wire close to electrical cables avoid parallel running. It is best to cross the cables at right angles to minimise any signal interruption to the point of crossing only.

Safety features

Antenna wire interruption warning - if the antenna wire is interrupted or disconnected, the transmitter starts to emit beep sounds and **X** symbol will show on display.

Warning zone evacuation - after approximately 8 seconds of continuous presence in the warning zone, the dog will be warned to leave the zone by one short stimulation impulse. The cycle will be repeated after 8 seconds until the dog leaves the warning zone.

Correction zone evacuation - if the dog remains in the correction zone for more than 10 seconds the **d-fence** receiver stops emitting stimulation impulses.

Caution

- Keep away from children.
- Do not leave the device in or around a high temperature heat source.
- Protect the receiver from water intrusion. (Check the seal and the screws tightness.)

- The transmitter is not waterproof. Protect from water intrusion.
- During the thunderstorm, disconnect the adapter from the electric outlet and unplug the antenna connector.
- If the receiver is not in use for 3 months or more, remove the battery.
- Never leave an old battery in the receiver, it could cause irreversible damage.
- If you have not used the receiver, check carefully before use if it is working properly.
- Do not expose the receiver to high temperatures.
- Before putting the collar with a receiver on your dog we recommend to do preventive health checkup.
- Repeated friction of contact points on the dog's skin can cause irritation. If you discover signs of irritation, remove the collar with a receiver and do not use it until all traces of irritation disappear.
- Never leave a dog to wear the collar with a receiver for more than 12 hours daily.
In case you let the dog in the house, we recommend to take off the electronic collar.

Maintenance

It is important to keep the device clean, but avoid using any detergent that contains strong chemicals. To clean your **d-fence** use a soft cloth moistened with water and neutral detergent. The transmitter unit is not waterproof, so use caution when operating your device in wet conditions, water can cause irreversible damage to your transmitter. The receiver is waterproof, it is provided with a seal that forms a waterproof barrier between the housing lid and main housing of the receiver. If the seal is loose, out of alignment or twisted, it will compromise the waterproof integrity of the case. Lubricating the seal with a thin layer of silicone grease will increase its lifespan. We recommend to replace the seal in the receiver every year. If the device will not be in use for a month or longer, it is recommended to remove the battery from the receiver.

Tip: While using the device, it is recommended to check periodically that screws in the receiver lid are tightened correctly.

Using d-fence in winter

When using d-fence in winter, please keep in mind:

- **Low humidity** – causes less skin conductivity. It is necessary to provide better conductivity between the contact points of the receiver and the dog's skin. This can be achieved by lubricating the dog's skin in the point of contact with vaseline, baby oil, hand lotion, etc.
- **Heavier dog's coat** – it is necessary to tighten the collar so that the permanent contact with the dog's skin is ensured. If the coat is too thick, it is recommended to cut the hair or choose a longer type of contact points.
- **Battery properties change** – temperatures below 0 °C slow down chemical reactions in batteries. To ensure a performance of repetitive impulses (especially of higher levels), it is recommended to insert a new battery into the receiver for the winter time. During the training, observe continuously dog's reactions and increase the stimulation impulse level as needed.

Troubleshooting

- If your device seems to operate improperly, read this manual again, check the receiver battery and replace it if necessary.
- Try to initialize the receiver by removing the battery for approximately 30 seconds, then put the battery back in its place observing the correct polarity.
- Check the fit and tightness of the receiver collar. The collar must be just tight enough to allow the contact points to make good contact on your dog's skin. The collar should be tight enough to fit two fingers between the collar and your dog's neck, but not so tight that it restricts your dog's breathing. If needed change contact points for longer ones.
- If the transmitter unit indicates an interrupted antenna wire loop, please make sure that the antenna wire is properly connected to the transmitter unit and that the loop is not interrupted. If the antenna wire loop is mechanically stressed in the points of connection or the connections are effected by humidity, the contact resistance may occur with time. In this case, the device might not work properly (manifested by a considerable shortening of the set zones). If you own an ohmmeter (or you can borrow it), this problem can be revealed by a control measuring of the resistance of the antenna wire loop. Using a wire with recommended cross section

for a given length of antenna wire installation (0,75 mm², 1 mm², 1,5 mm² or 2,5 mm²), the resistance value should be maximum 2 Ω per 100 m of wire. For example, if you use three packages of wire (one package is 100 m), the electric resistance of the wire should be maximum 6 Ω. If the resistance is much higher, check all connections and make connections on the antenna wire again if needed.

- Check the antenna wire connections and connection to the transmitter.
- Check the transmitter power supply.
- If you suspect a malfunction of the device, check that there is not a strong source of interference nearby (see Function ISIT). Examples of strong source interference, which may adversely affect the correct functioning of the device d-fence is a signal generated from the boundary wire of a robotic lawn mower system or any poor performance filtration converters energy produced by solar panels.
- If the problem still persists, contact the dealer.

Technical specifications

Transmitter

- Model 202/2002for installations up to 2200 m
- Warning zone width of the zone from 0 to minimum 7 m
- Correction zone width of the zone from 0 to minimum 7 m
- Power AC adapter 230V / 50Hz, 15V / 300mA
- Max. covered area 30 ha (square-shaped installation)
- Watertightness not waterproof
- Operating temperature between -10 °C and +50 °C
- Dimensions 116 x 156 x 35 mm
- Back-up power supply Battery pack 9,6V

Receiver

- Dimensions 64 x 43 x 34 mm
- Weight 60 g (without battery)
- Power CR2 3V lithium battery
- Battery life 6 months in stand-by
- Collaradjustable to neck size from 20 to 70 cm
- Operating temperature between -10 °C and +50 °C
- Watertightness waterproof
- Stimulation impulse levels 8

Antenna Wire

Choose suitable wire cross-section of the antenna wire according to the length of the antenna wire loop.

Installation up to 400 mantenna wire cross-section of 0,75 mm²

Installation from 400 m to 600 mantenna wire cross-section of 1 mm²

Installation from 600 m to 900 m ...antenna wire cross-section of 1,5 mm²

Installation from 900 m to 2200 m ..antenna wire cross-section of 2,5 mm²

Note: Model d-fence 2002 is supplied with 100 m antenna wire of 0,75 mm² cross-section.

Warranty terms and conditions

VNT electronics s.r.o. provides a 2-year warranty on the **Dogtrace** products with respect to defects in material and workmanship under normal use and service from the date of the original purchase.

The limited warranty does not cover the following:

- batteries
 - straps
 - damage resulting from misuse, accident, modification or alteration to hardware or software, tampering, unsuitable physical or operating environment beyond product specifications, improper maintenance, or failure caused by a product for which VNT electronics s.r.o. is not responsible.
1. The warranty period commences on the date of purchase. The sales receipt or your purchase invoice showing the date of purchase of the product, showing the serial number and date of purchase of the product, is the proof of the date of purchase.
 2. Within the warranty period, VNT electronics s.r.o. will, at no additional charge; perform repair or replacement of defects in workmanship or parts covered by this warranty.
 3. The warranty does not cover damage resulting from:
 - a) transportation, fall, weather, extreme temperatures, improper use, mishandling or negligence after the purchase of the product
 - b) natural disaster (wind, earthquake, lightning storm etc.)
 - c) maintenance or misuse other than in accordance with the instructions provided by VNT electronics s.r.o. in relation to the product
 - d) modification by a party not authorized by VNT electronics s.r.o.
 4. The warranty provided only applies to the product purchased from official dealer.
 5. We require that all items being sent for repair must be clean. Items deemed insufficiently clean will be returned to the customer unrepaired. Please do not include the strap or any other accessories if not subject to warranty.
 6. Other rights and liabilities of the manufacturer and claimants are based on relevant general obligatory legal regulations of the country where the product was sold.

The content of this user guide may be subject to change without prior notice.

Installation drawing

Here is the space for your drawing of your antenna wire installation and note of **connection locations**.

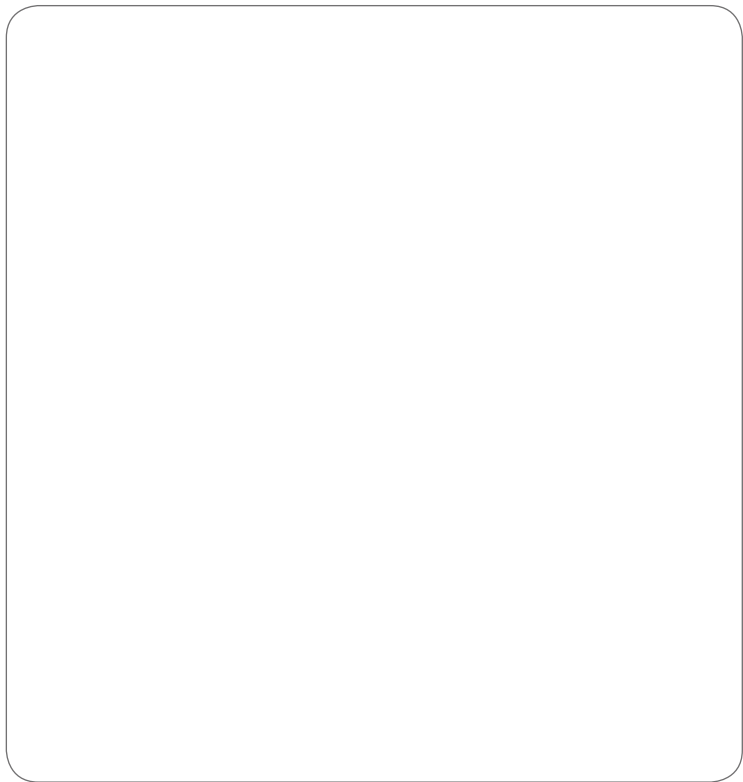

Notes:

Wall-mount screw hole template

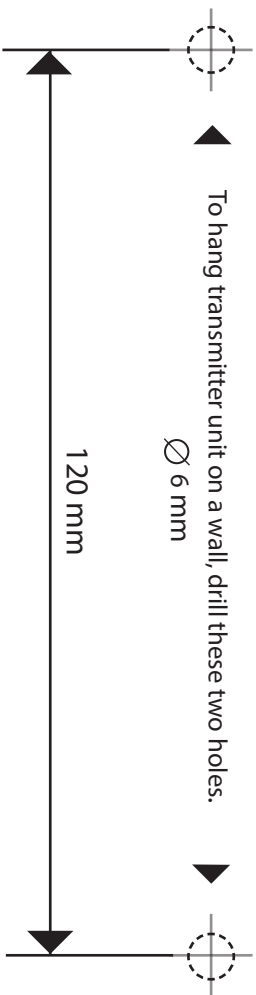

To hang transmitter unit on a wall, drill these two holes.

∅ 6 mm

120 mm



Cut here