

GARMIN[®]

Alpha[®] 100 with TT[™] 15/TT 15 mini



Owner's Manual

© 2016 Garmin Ltd. or its subsidiaries

All rights reserved. Under the copyright laws, this manual may not be copied, in whole or in part, without the written consent of Garmin. Garmin reserves the right to change or improve its products and to make changes in the content of this manual without obligation to notify any person or organization of such changes or improvements. Go to www.garmin.com for current updates and supplemental information concerning the use of this product.

Garmin®, the Garmin logo, Alpha®, ANT+®, BlueChart®, and City Navigator® are trademarks of Garmin Ltd. or its subsidiaries, registered in the USA and other countries. BaseCamp™, TT™, and tempe™ are trademarks of Garmin Ltd. or its subsidiaries. These trademarks may not be used without the express permission of Garmin.

microSD™ and the microSDHC logo are trademarks of SD-3C, LLC. Windows® and Windows NT® are registered trademarks of Microsoft Corporation in the United States and other countries. Mac® is a trademark of Apple Computer, Inc., registered in the U.S. and other countries.

Other trademarks and trade names are those of their respective owners.

Table of Contents

Getting Started	1	Tracking a Contact.....	8
Setting Up the Alpha System.....	1	Finding Your Contact ID.....	8
Device Overviews.....	1	Changing Your Contact ID.....	8
Alpha 100 Handheld Device.....	1	Updating a Contact ID.....	8
Dog Collar Device.....	1	Hunting with the Alpha System	8
Getting More Information.....	1	Marking Your Truck Location.....	8
Registering Your Device.....	1	Marking a Covey.....	8
Installing the Battery Pack.....	1	Turning On the Collar Light.....	8
Charging the Handheld Device.....	2	Turning On Rescue Mode.....	8
Charging the Dog Collar Device.....	2	Waypoints, Routes, and Tracks	8
Turning On the Devices.....	2	Waypoints.....	8
Turning Off the Devices.....	2	Marking Your Current Location.....	8
Acquiring Satellite Signals.....	2	Marking a Waypoint Using the Map.....	8
Using the Touchscreen.....	2	Editing a Waypoint.....	8
Locking the Touchscreen.....	2	Repositioning a Waypoint to Your Current Location.....	9
Unlocking the Touchscreen.....	2	Moving a Waypoint on the Map.....	9
Dog Collar Device Setup	2	Increasing the Accuracy of a Waypoint Location.....	9
Methods to Add a Dog Collar Device to a Handheld Device.....	2	Projecting a Waypoint.....	9
VHF Radio Information.....	3	Deleting a Waypoint.....	9
Adding a Dog Using Wireless Pairing.....	3	Routes.....	9
Adding a Dog Using the Track and Train Codes.....	3	Creating a Route.....	9
Sharing a Dog Wirelessly.....	3	Editing the Name of a Route.....	9
Editing Dog Information.....	3	Navigating a Saved Route.....	9
Resetting a Dog's Statistics and Track.....	3	Editing a Route.....	9
Changing the Length of the Dog's Track.....	3	Reversing a Route.....	9
Changing the Dog Name.....	3	Viewing a Route on the Map.....	9
Changing the Color of the Dog's Track.....	3	Viewing the Active Route.....	9
Changing the Dog Type.....	3	Deleting a Route.....	9
Changing the Dog ID.....	4	Tracks.....	9
Setting Dog Alerts.....	4	Recording Track Logs.....	9
Removing a Dog.....	4	Viewing Details about the Track.....	10
Fitting the Collar on Your Dog.....	4	Viewing the Elevation Plot of a Track.....	10
Enabling Bark Detection.....	4	Navigating to the Start of a Track.....	10
Communication with the Collar.....	4	Changing the Track Color.....	10
Enter Sleep Mode.....	4	Saving the Current Track.....	10
Exit Sleep Mode.....	5	Saving a Location on a Track.....	10
Dog Tracking	5	Clearing the Current Track.....	10
Tracking Your Dog on the Map.....	5	Deleting a Track.....	10
Tracking and Training One Dog at a Time.....	5	Archiving a Saved Track.....	10
Dog Status Icons.....	5	Archiving Tracks Automatically.....	10
Dog Tracking Compass.....	5	Sending and Receiving Data Wirelessly.....	10
Navigating to Your Dog.....	5	Navigation	10
Tracking with BaseCamp™ BaseStation.....	5	Map.....	10
Pausing Dog Tracking.....	5	Measuring Distance on the Map.....	10
Pausing All Dog Tracking.....	5	Compass.....	10
Location Alerts.....	5	Calibrating the Compass.....	10
Setting a Geofence Alert.....	6	Navigating with the Bearing Pointer.....	10
Setting a Radius Alert.....	6	Course Pointer.....	11
Editing Location Alerts.....	6	Where To? Menu.....	11
Dog Training	6	Finding a Waypoint by Name.....	11
Selecting and Installing the Contact Points.....	6	Finding a Waypoint Near Another Waypoint.....	11
Removing the Contact Points.....	6	Navigating with Sight 'N Go.....	11
Training Methods.....	6	Elevation Plot.....	11
Linear and Traditional Stimulation.....	6	Calibrating the Barometric Altimeter.....	11
Choosing the Correct Intensity Level.....	6	Navigating to a Point on the Plot.....	11
Setting Up the Training Keys for One Intensity Level.....	6	Changing the Plot Type.....	11
Customizing the Training Keys.....	7	Resetting the Elevation Plot.....	11
Collar Training.....	7	Trip Computer.....	11
Contact Tracking	7	Resetting the Trip Computer.....	11
Adding a Contact Using MURS/VHF.....	7	Applications	11
Adding a Contact Using a Contact ID.....	7	Setting a Proximity Alarm.....	11
Initiating an Emergency Alert.....	7	Calculating the Size of an Area.....	11
Sending a Message to Your Contacts.....	8	Viewing the Calendar and Almanacs.....	11
		Setting an Alarm.....	12
		Opening the Stopwatch.....	12

Satellite Page	12
Changing the Satellite View	12
Turning Off GPS	12
Simulating a Location	12
VIRB® Remote	12
Controlling a VIRB Action Camera with Your Handheld Device	12
Customizing Your Device	12
Customizing the Main Menu	12
Customizing the Data Fields	12
Enabling the Map Data Fields	12
System Settings	12
Dog Settings	12
Contact Settings	12
Display Settings	12
Calibrating the Touchscreen	13
Appearance Settings	13
Setting the Device Tones	13
Map Settings	13
Advanced Map Settings	13
Track Settings	13
Routing Settings	13
Changing the Units of Measure	13
Time Settings	13
Position Format Settings	13
Heading Settings	13
Altimeter Settings	14
Marine Map Settings	14
Device Information	14
Viewing Device Information	14
Support and Updates	14
Support and Updates	14
Updating the Software	14
Device Care	14
Cleaning the Device	14
Cleaning the Touchscreen	14
Specifications	14
Alpha 100 Handheld Device Specifications	14
TT 15 Dog Collar Device Specifications	15
TT 15 mini Dog Collar Device Specifications	15
Battery Information	15
Long-Term Storage	15
Maximizing the Battery Life	15
Saving Energy While Charging the Device	16
Data Management	16
File Types	16
Installing a Memory Card	16
Connecting the Handheld Device to a Computer	16
Connecting the Collar to a Computer	16
Transferring Dog Tracks to BaseCamp	16
Deleting Files	16
Disconnecting the USB Cable	17
Appendix	17
Accessories and Replacement Parts	17
Purchasing Accessories	17
ANT+ Sensors	17
TT 15 Battery Replacement Instructions	17
Replacing the Dog Collar Device Battery	18
Replacing the Collar Strap	18
Replacing the VHF Antenna in the Dog Collar Device	18
Changing the Fuse in the Vehicle Power Cable	18
Data Field Options	19
Index	21

Getting Started

⚠ WARNING

See the *Important Safety and Product Information* guide in the product box for product warnings and other important information.

Setting Up the Alpha System

NOTICE

Avoid using a high-powered radio (greater than 5 watts) in close proximity to the device. It may cause irreversible damage to the device.

Before you can use the Alpha handheld device and the TT 15 dog collar device, you must set up the devices.

- 1 Install the battery in the handheld device (*Installing the Battery Pack*, page 1).
- 2 Charge the handheld device (*Charging the Handheld Device*, page 2).
- 3 Charge the dog collar device (*Charging the Dog Collar Device*, page 2).
- 4 Turn on the devices (*Turning On the Devices*, page 2).
- 5 If necessary, add the dog collar device to the handheld device (*Adding a Dog Using Wireless Pairing*, page 3).
- 6 Acquire satellite signals (*Acquiring Satellite Signals*, page 2).
- 7 Attach the collar (*Fitting the Collar on Your Dog*, page 4).

Device Overviews

Alpha 100 Handheld Device



①	GPS antenna
②	VHF radio antenna
③	Training keys
④	Power key
⑤	Mounting spine
⑥	microSD™ memory card slot (under battery)
⑦	Battery cover D-ring
⑧	Mini-USB port (under weather cap)

Dog Collar Device

NOTE: Your dog collar device may look different than the device pictured.

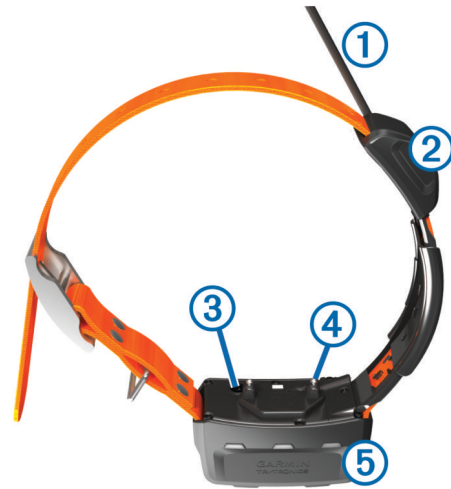

①	VHF antenna
②	GPS antenna
③	Power key
④	Contact points
⑤	Status LED and flashing beacon LEDs

Getting More Information

You can find more information about this product on the Garmin® website.

- Go to www.garmin.com/alpha.
- Go to www.garmin.com/outdoor.
- Go to www.garmin.com/learningcenter.
- See the owner's manual for your dog collar device for more information.
- Go to buy.garmin.com, or contact your Garmin dealer for information about optional accessories and replacement parts.

Registering Your Device

Help us better support you by completing our online registration today.

- Go to garmin.com/express.
- Keep the original sales receipt, or a photocopy, in a safe place.

Installing the Battery Pack

- 1 Turn the D-ring counter-clockwise, and pull up to remove the cover.
- 2 Locate the metal contacts on the end of the lithium-ion battery.
- 3 Insert the battery into the compartment, contacts first.



- 4 Press the battery into place.
- 5 Replace the battery cover, and turn the D-ring clockwise.

Charging the Handheld Device

NOTICE

To prevent corrosion, thoroughly dry the USB port, the weather cap, and the surrounding area before charging or connecting to a computer.

You should fully charge the battery before you use the device for the first time. Charging a fully depleted battery takes about 2 hours.

NOTE: The device does not charge when it is outside the temperature range of 0° to 40°C (32° to 104°F).

- 1 Lift the weather cap ①.



- 2 Plug the small end of the power cable into the mini-USB port ② on the device.
- 3 Plug the other end of the power cable into an appropriate power source.

The LCD display on the handheld device shows the current battery charge level. Charging is complete when the battery charge level icon stops flashing.

Charging the Dog Collar Device

NOTICE

To prevent corrosion, thoroughly dry the contacts on the collar and the surrounding area before connecting the charging clip.

NOTE: Your dog collar device may look different than the device pictured.

You should fully charge the battery before you use the device for the first time. Charging a fully depleted battery takes about five hours.

- 1 Snap the charging clip ① onto the device ②.

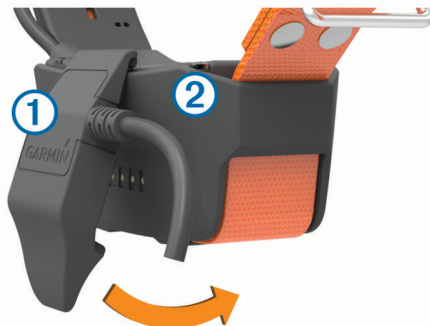

- 2 Plug the small end of the power cable into the mini-USB port on the charging clip cable.
- 3 Plug the power cable into a power source.
The status LED is solid red when the collar is charging.
- 4 After the status LED turns solid green, remove the charging clip from the collar.

Turning On the Devices

- On the handheld device, hold the power key until the LCD display turns on.
- On the dog collar device, hold the power key until the status LED flashes and the collar beeps.

Turning Off the Devices

- On the handheld device, hold the power key until the LCD screen turns off.
- On the dog collar device, hold the power key until the status LED turns red.

Acquiring Satellite Signals

Both the collar and handheld device must acquire satellite signals before you put the collar on your dog. Acquiring satellites can take a few minutes.

- 1 Go outdoors to an open area.
- 2 Turn on both devices ([Turning On the Devices, page 2](#)).
- 3 Select the power key on the handheld device.

■■■■ shows the GPS signal strength.

When the collar has acquired satellite signals, the status LED flashes a double-blink or triple-blink in green.

Using the Touchscreen

- Select to open the application drawer.
- Select to open a menu.
- Select to close the page and return to the previous page.
- If you are more than one menu from the home screen, select and hold to return to the home screen.
- Select to return to the previous page.
- Select to save changes and close the page.
- Select and to scroll.
- Select to search by name.

Locking the Touchscreen

You can lock the screen to prevent inadvertent screen touches.

- 1 Select the **Power** key.
- 2 Select .

Unlocking the Touchscreen

- 1 Select the **Power** key.
- 2 Select .

Dog Collar Device Setup

Methods to Add a Dog Collar Device to a Handheld Device

If you purchased the dog collar device and the handheld device separately, you must add the dog collar device to the handheld device. You can add up to 20 dog collar devices to one handheld device.

Using MURS/VHF: Allows you to add a dog collar device after you have placed the dog collar device into pairing mode by pressing the power key.

This method is helpful when you are adding a new accessory collar to the system prior to leaving for the hunt ([Adding a Dog Using Wireless Pairing, page 3](#)).

Entering the track and train codes: Allows you to add a dog collar device that you do not own and that is not in the area. The dog's owner must determine if you can only track the dog or can track and train the dog. This method requires the dog's owner to find and communicate the codes to the person adding the dog collar device.

This method is helpful when you would like to add a dog collar device during a hunt, but you are not near the dog. For example, you are adding another member of your hunting party's dog collar device to your handheld device, but you do not own the dog collar device ([Adding a Dog Using the Track and Train Codes, page 3](#)).

NOTE: This feature varies based on dog collar device type and feature availability in your area. You may see track codes only or track and train codes.



Sharing wirelessly using ANT+® wireless technology: Allows you to add a dog collar device that you do not own and that is not in the area. The dog's owner must determine if you can only track the dog or can track and train the dog. This method does not require the dog's owner to find and communicate the codes to the person adding the dog collar device. This method also adds dog information, such as the dog's name, communication settings, and initial position, from the sending handheld device to your device. The two handheld devices must be within range 3 m (10 ft.) to share data wirelessly.

This method is helpful when you want to add a dog collar device during a hunt, but you are not near the dog. For example, the dogs have already been let loose, and you are near the dog owner, who can share the dog wirelessly ([Sharing a Dog Wirelessly, page 3](#)).

VHF Radio Information

This product may be used only on specific radio frequencies, which vary depending on the country of use. See the product packaging or go to www.garmin.com/tracking-legal for details about the radio frequency of this product.

Adding a Dog Using Wireless Pairing



- 1 If the dog collar device is on, turn off the dog collar device ([Turning Off the Devices, page 2](#)).
- 2 Hold  until the dog collar device emits two series of beeps (about 2 seconds), and then release .
The status LED flashes rapidly in green. The dog collar device is now ready to be linked, or paired, with a handheld device.
- 3 On the handheld device, select **Dog List > Add Dog**.
- 4 Bring the dog collar device near the handheld device, and select **Yes**.
- 5 After successfully adding the dog collar device, enter the name of the dog, and select  > **OK**.

Adding a Dog Using the Track and Train Codes

NOTE: This feature varies based on dog collar device type and feature availability in your area.

Before you can add a dog using the track and train codes, the dog owner must find the track and train codes ([Finding the Dog ID and Track and Train Codes, page 3](#)) and tell them to you.

If you are not near the dog you want to add or you cannot put the collar into pairing mode, you can add the dog using the track and train codes.

- 1 Select **Add Dog**.
- 2 When asked if you are near the collar, select **No**.
- 3 When asked if you know the track and train codes, select **Yes**.
- 4 Enter the track or train code for the collar, and select .
The dog's track code allows you to track the dog. The dog's train code allows you to both track and train the dog.
- 5 Enter the name of the dog, and select  > **OK**.

Finding the Dog ID and Track and Train Codes

You can share a dog's track code so another person can view your dog's location with the map and dog tracking compass. Also, you can share a dog's train code so another person can track your dog and train (correct) your dog.

- 1 Select **Dog List**.
- 2 Select a dog.
- 3 Select **Show Info**.

Sharing a Dog Wirelessly

Before you can share data wirelessly over ANT+, you must bring your Alpha handheld device within 10 ft. (3 m) of the other handheld device.

- 1 Select **Dog List**.
- 2 Select the dog to share.
- 3 Select **Share Wirelessly**.
- 4 Select an option:
 - To allow the other person only to track your dog's location with the map and dog tracking compass, select **Track Only**.
 - To allow the other person to track your dog and correct your dog's behavior, select **Track and Train**.
- 5 On the other handheld device, select **Dog List >  > Receive Wirelessly**.

Editing Dog Information

Resetting a Dog's Statistics and Track

You might want to clear the dog statistics and track before a new hunt.

- 1 Select **Dog List**.
- 2 Select a dog.
- 3 Select **Show Info > Reset > Yes**.

Changing the Length of the Dog's Track

You can adjust the length of the dog's tracks shown on the map. Showing less tracks on the map can help to declutter the map view. Changing the length of the track shown on the map does not affect the tracks stored in the internal memory.

- 1 Select **Setup > Dogs > Dog Track On Map**.
- 2 Select an option to show more or less of the tracks on the map.

Changing the Dog Name

- 1 Select **Dog List**.
- 2 Select a dog.
- 3 Select **Show Info**.
- 4 Select the dog's name.
- 5 Enter the name, and select  > **OK**.

Changing the Color of the Dog's Track

You can change the track color of the dog. It is helpful to have the track color match the color of the collar strap, if possible.

- 1 Select **Dog List**.
- 2 Select a dog.
- 3 Select **Show Info**.
- 4 Select the colored square next to the dog's name.
- 5 Select a color.

Changing the Dog Type

Before you can change the dog type, the collar must be turned on and within range of the handheld device.

- 1 Select **Dog List**.
- 2 Select a dog.
- 3 Select **Show Info >  > Change Dog Type**.
- 4 Select a dog type.

Changing the Dog ID

Before you can change the dog ID, the collar must be turned on and within range of the handheld device.

If you are experiencing interference from other collars or handheld devices in the area, you might need to change the ID for the dog.

- 1 Select **Dog List**.
- 2 Select a dog.
- 3 Select **Show Info**.
- 4 Select  > **Change ID**.
- 5 Select an available ID.

If another handheld device is tracking this dog, for best results, remove the dog from the device, and use the track and train codes ([Adding a Dog Using the Track and Train Codes, page 3](#)) or share wirelessly over ANT+ ([Sharing a Dog Wirelessly, page 3](#)) to add the dog again.

Setting Dog Alerts

You can adjust how the handheld device alerts you to certain actions of the dog.

- 1 Select **Setup > Dogs > Dog Alerts**.
- 2 Select an alert.
- 3 Select the handheld device action for the specific alert.
- 4 Repeat steps 2 and 3 as needed.

Removing a Dog

- 1 Select **Dog List**.
- 2 Select a dog.
- 3 Select **Remove**.

Fitting the Collar on Your Dog

CAUTION

To prevent irritation from the contact points, remove the collar for at least eight hours out of every 24-hour period.

This device is not intended for human use. Do not attempt to use on any person.

Do not spray the device or collar with harsh chemicals including but not limited to flea or tick spray. Always ensure that any flea or tick spray that is applied to the dog is completely dry before placing the collar on the dog. Small amounts of harsh chemicals can damage the plastic components and collar laminate.

In order to effectively train the dog, the collar and device must fit the dog properly. If the collar is too loose or positioned incorrectly, stimulation may be inconsistent. This can delay or prevent successful training.

- 1 Position the device at the front of the dog's neck, with the status LED facing toward the dog's chin and the contact points against the throat.
- 2 Tighten the strap so that it is very snug around the dog's neck, and fasten the buckle.

NOTE: The collar should fit tightly and should not be able to rotate or slide on the dog's neck. The dog must be able to swallow food and water normally. You should observe your dog's behavior to verify that the collar is not too tight.

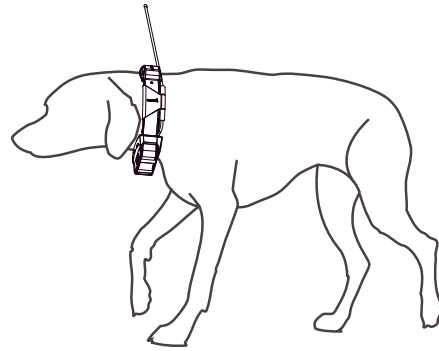

- 3 Wiggle the device to work the contact points through the dog's coat.
NOTE: The contact points must have contact with the dog's skin to be effective.
- 4 If the strap is too long, cut off the excess, leaving at least 8 cm (3 in.) to spare.
TIP: You can mark the hole used to fasten the buckle for future reference.

Enabling Bark Detection

NOTE: This feature is not available in all areas.



Select **Setup > Dogs > Bark Detection**.

A barking icon appears on the dog tracking page and the map page.

When the dog collar device is active and properly fitted on the dog ([Fitting the Collar on Your Dog, page 4](#)), it detects barks automatically. After bark detection is enabled, you can set up a bark alert ([Setting Dog Alerts, page 4](#)).

Communication with the Collar

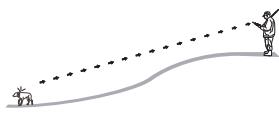
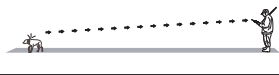
You should keep an unobstructed line of sight between your handheld device and the dog collar device to produce the best communication signal. To achieve the best line-of-sight conditions, you should move to the highest elevation point in your area (for example, on the top of a hill).

Best	
Good	
Poor	

Enter Sleep Mode

Before you can turn on sleep mode, you must track your dog's location using the TT 15 mini dog collar device.

When connected with the Alpha handheld device, the TT 15 mini dog collar device can be put into sleep mode to conserve the battery when you are not actively tracking your dog.

- 1 Select **Dog List**.
- 2 Select a dog.
- 3 Select **Show Info >  > Collar Sleep Mode > Sleep**.

On the Dog Info page, the Update Rate switches to Sleep Mode.

Exit Sleep Mode

You can turn off sleep mode on the TT 15 mini dog collar device while you are not actively tracking your dog.

- 1 Select **Dog List**.
- 2 Select a dog.
- 3 Select **Show Info** > **≡** > **Collar Sleep Mode** > **Wake**.

On the Dog Info page, the Sleep Mode switches to Update Rate mode.

Dog Tracking

The handheld device allows you to track your dog, using the tracking compass or map. The map displays your location and your dog's location and tracks. The compass pointer indicates the direction of the dog's current location.

Tracking Your Dog on the Map

Before you can track a dog on the map, you must add it to the handheld device (*Adding a Dog Using Wireless Pairing, page 3*).

You can view the dog's location on the map.

- 1 From the home screen, select .

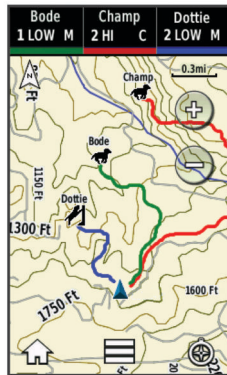

- 2 If necessary select **+** and **-** to zoom in and out of the map.

TIP: If necessary, select  to track the dog using the dog tracking compass (*Dog Tracking Compass, page 5*).





Tracking and Training One Dog at a Time

NOTE: This feature applies only to dog collar devices with training features.

When you are tracking and training multiple dogs, you can enable the device to display only one dog at a time, and you can ensure the dog being viewed on the compass is the dog being trained.

- 1 Select  > **≡** > **List Sync On**.
- 2 Select **◀** and **▶** to cycle through the dogs.

Dog Status Icons

	Sitting
	Running
	On point
	Treed
	Unknown ¹

Dog Tracking Compass

To open the dog tracking compass, select .

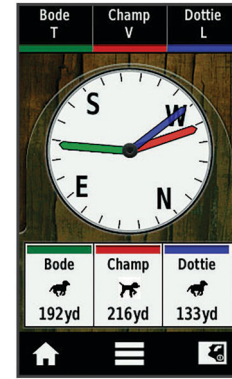

You can use the dog tracking compass to view the direction and distance to your dog. The dog tracking compass also shows the dog's status, such as running or on point (*Dog Status Icons, page 5*). The color of the pointer corresponds to the color of the dog track.

The dog tracking compass is most accurate when the dog is more than 9.1 m (30 ft.) away. When the dog is less than 9.1 m (30 ft.) away, "Near" appears.

Navigating to Your Dog

- 1 Select **Dog List**.
- 2 Select the dog.
- 3 Select **Show Info** > **Go**.
The map opens.
- 4 Follow the magenta line to the dog.
- 5 If necessary, select  to track the dog using the dog tracking compass.

Tracking with BaseCamp™ BaseStation

Before you can track your dogs and contacts using BaseCamp, you must download BaseCamp to your computer (www.garmin.com/basecamp).

The BaseStation feature of BaseCamp allows you to track your dogs and contacts in real-time on a computer. For more information on using BaseCamp, see the help file in the application.

- 1 Select **Setup** > **System** > **BaseCamp BaseStation** > **Prompted**.
- 2 Open BaseCamp.
- 3 Follow the on-screen instructions.

Pausing Dog Tracking

You can pause the tracking of a single dog during a hunt. This can be helpful if the dog is taking a break.

- 1 Select **Dog List**.
- 2 Select a dog.
- 3 Select **Show Info** > **≡** > **Stop Tracking**.

Pausing All Dog Tracking

If you are moving the dogs during a hunt and you do not want to record the transportation of the dogs, you can pause the tracking of all of the dogs.

- 1 Select .
- 2 Select **≡** > **Pause All Tracking**.

Location Alerts

Location alerts notify you when your dogs or contacts enter or exit a particular location. You can create a custom geofence or use a radius around your current location.

¹ The unknown status icon indicates that the collar has not acquired a satellite signal and that the handheld device cannot determine the location of the dog.

A geofence is an invisible boundary around an area and is created using points on the map. The virtual boundaries of a geofence are accurate up to approximately 10 ft. (3 m). Geofences perform best when sized to cover an area encompassing an average sized backyard (approximately ¼ acre).

Setting a Geofence Alert

You can set up an invisible boundary around an area and receive an alert when a dog or contact enters and exits that area.

- 1 Select **Setup > Location Alerts > Add Alert > Geofence**.
- 2 Select a point on the map, and select **Use**.
- 3 Repeat step 2 to define a geofence with up to 10 points.
- 4 Select **Done**.

Setting a Radius Alert

You can receive an alert when a dog or contact gets within or outside of a certain distance away from you.

- 1 Select **Setup > Location Alerts > Add Alert > Radius**.
- 2 Select the unit of measurement.
- 3 Enter the radius distance, and select **✓**.

Editing Location Alerts

- 1 Select **Setup > Location Alerts**.
- 2 Select an alert.
- 3 Select an option:
 - Select **Disable** to turn off notifications for this alert.
 - Select **Set Alert Type** to set the way the device notifies you for this alert.
 - Select **Set Alert Mode** to set the notification to sound on exit, entrance, or both.
 - Select **Delete** to remove the alert.

Dog Training

You should research and investigate the training methods best suited for you, your dog, and your needs. This manual provides some basic guidelines for training, but each dog has unique training needs.

When used properly, the Alpha training system is a very effective training tool to aid your dog in reaching its full potential. The use of the training system should be part of an overall training program.

Begin training your dog on a leash, without the Alpha training system. You should train your dog how to heel, sit, and come to you. After the dog understands these three basic commands, you can begin training with the dog collar device and the leash. Finally, when the dog consistently obeys commands using the leash and collar, you may be able to remove the leash to train with only the dog collar device.

Selecting and Installing the Contact Points

For best results, select the correct contact points based on your dog's coat.

- 1 Select the correct contact point length for your dog's coat type:
 - For dogs with thicker coats, use the longer contact points.
 - For dogs with shorter coats, use the shorter contact points.
- 2 If necessary, use the included wrench to remove the contact points.
- 3 Twist the contact points into the collar.
- 4 Tighten with the included wrench, but do not overtighten.

When you put the collar on the dog, make sure the contact points are tight against the neck.

Removing the Contact Points

When you are not training the dog using the training keys, remove the contact points.

- 1 Use the included wrench to remove both contact points.
- 2 Place the cap over the contact point holes.

Training Methods

Momentary stimulation: Applies a brief stimulation when you press the training key, regardless of how long the key is depressed.

Continuous stimulation: Applies stimulation to the dog the entire time you press the training key, for a maximum of 8 seconds. Your stimulations should typically be much shorter than 8 seconds.

Tone: Activates an audible tone instead of stimulation. A tone can be used as either a positive or negative training cue, depending on your training program.

Vibration: Applies vibration instead of stimulation to the dog the entire time you press the training key, for a maximum of 8 seconds. The effectiveness of vibration may vary based on the dog's temperament and experience.

Linear and Traditional Stimulation

You can use linear or traditional stimulation to customize your training experience. The default intensity method is linear, which allows progressive stimulation from level 1 to level 18. Traditional stimulation allows you to make quick changes using low, medium, and high settings within predetermined stimulation levels (1 through 6).

Choosing the Correct Intensity Level

- 1 Set the intensity to the lowest level (*Customizing the Training Keys, page 7*).
- 2 Select a training key.
- 3 Observe the dog for a reaction, such as a head shake, neck movement, or just a change in expression.

Sometimes dogs will vocalize due to the surprise of the electrical stimulation. If the dog vocalizes more than once, the intensity level is too high for beginning training.
- 4 If there is no reaction, increase the intensity level by one level until the dog has a slight but recognizable reaction to the stimulation.

The intensity level that causes a slight but recognizable reaction is your dog's baseline level for beginning collar training. You do not need to, and should not, apply this intensity selection test again.

After you begin training, the dog's performance guides your intensity selection. As the dog advances in training, you may need to change the level depending upon the training situation.

Setting Up the Training Keys for One Intensity Level

Before you can assign the training keys to a dog, you must add the dog to the handheld device (*Adding a Dog Using Wireless Pairing, page 3*).

By default, the training keys are set to the lowest stimulation setting, with momentary (M), continuous (C), and tone (T) or vibration (V) for each key. This mode is most useful when training only one dog. When training multiple dogs, it may be helpful to customize a training key for each dog and for each intensity level (*Customizing the Training Keys, page 7*).

- 1 Select **Setup > Training > Training Buttons**.
- 2 Select the area at the top of the screen directly below the keys.

- 3 Select **—** or **+** to choose the intensity level for each of the stimulation keys.
- 4 If you are using traditional stimulation mode, select **LOW**, **MED**, or **HI**.
- 5 Select **↩**.

In this mode, the left key provides momentary simulation. The center key provides continuous stimulations. The right key provides a tone or vibration.

Customizing the Training Keys

Before you can assign the training keys to a dog, you must add a dog to the handheld device (*Adding a Dog Using Wireless Pairing*, page 3).

You can assign a specific dog intensity level and stimulation mode to each training key. You can add multiple pages of training key settings. This mode is most useful when training multiple dogs. When training only one dog, it might be more useful to set only the intensity level.

- 1 Select **Setup > Training > Training Buttons > Change Mode**.
- 2 Select **+** below the key you are customizing.
- 3 Select the dog you want to train with this key.
- 4 Select **—** or **+** to choose the intensity level.
- 5 If you are using traditional stimulation mode, select **LOW**, **MED**, or **HI**.
- 6 Select momentary (**M**), continuous (**C**), tone (**T**), or vibration (**V**).
- 7 Repeat steps 3-6 for all three keys.
- 8 If you need to train with more than three keys, select **↩ > Insert Page**, and program the additional keys.
- 9 Select **↩**.

Collar Training

Begin training your dog on a leash, without using the Alpha training system. After the dog shows a grasp of the commands "heel," "sit," and "here," you can begin training with the collar and the leash.

During the initial stage of collar introduction, the dog learns that collar stimulation means the same thing as a tug on the leash. At first, the dog may be alarmed by the electronic stimulation. The key is to be patient and consistent and not to start off at too high of an intensity. Be fair and consistent, and use repetition and praise when using the collar as a training tool.

If the dog does not respond to the stimulation level you have selected (*Choosing the Correct Intensity Level*, page 6), increase the stimulation one level at a time until you achieve the appropriate response. After you achieve the desired response, you can lower the stimulation level as long as the dog maintains consistency.

As the dog becomes more proficient with the commands, you can begin to introduce distractions, such as rolling a ball in front of the dog or walking him in the presence of others.

After the dog begins to respond consistently to the command during collar training, you can remove the leash and train with just the collar.

NOTE: You should train without a leash only when it is appropriate for your environment and your dog's temperament. You should follow all laws and regulations for your area regarding the use of dog leashes.

Eventually in most training situations, your commands will not require stimulation to be given with the command. You should only use stimulation when you need to repeat a command because the dog did not obey the first one.

As the dog becomes better trained, you can decrease the use of collar training. Continue to have the dog wear the collar until you

feel certain that it is no longer needed to reinforce known commands. Abandoning the collar too early can lead to problems in the future.

Contact Tracking

You can track other hunters so you know where they are at all times. You can also send messages to your contacts. One Alpha handheld device can track up to 20 devices, including compatible dog collar devices and Alpha handheld devices.

Adding a Contact Using MURS/VHF

Before you can add a contact using MURS/VHF, you should be near the contact, and you must turn on the transmitter (*Turning On the Transmitter*, page 15).

You can add fellow hunters to your handheld device so you can track them on the map (*Tracking a Contact*, page 8) and send messages to them (*Sending a Message to Your Contacts*, page 8).

- 1 On your handheld device, select **▲ > Contacts > Add**.
- 2 Bring the two handheld devices near each other, and select **Yes** on your handheld device.
- 3 On the contact's handheld device, select **▲ > Contacts > Pair**.
- 4 On your handheld device, enter the name of the contact, and select **✓ > OK**.

The contact is added to your handheld device.

You can repeat this procedure using another hunter's handheld device to add your contact ID to that device.

Adding a Contact Using a Contact ID

Before you can add a hunter using a contact ID, the hunter must find the contact ID (*Finding Your Contact ID*, page 8) and send it to you. You must also turn on the transmitter (*Turning On the Transmitter*, page 15).

If you are not near the hunter you want to add, you can add the hunter using a contact ID.

- 1 On your handheld device, select **▲ > Contacts > Add**.
- 2 When asked if you are near the other handheld device, select **No**.
- 3 When asked if you know the contact ID, select **Yes**.
- 4 Select the contact ID for the contact you are adding.
- 5 Enter the name of the contact, and select **✓ > OK**.

The contact is added to your handheld device.

You can repeat this procedure using another hunter's handheld device to add your contact ID to that device.

Initiating an Emergency Alert

Before you can initiate an emergency alert, you must turn on the transmitter (*Turning On the Transmitter*, page 15).

Before someone can receive your emergency alert, someone must add you as a contact (*Adding a Contact Using MURS/VHF*, page 7).

You can use an emergency alert when you need immediate assistance and you are away from your group.

Select **▲ > Contacts > ▲ > Yes**.

When your contact accepts your emergency alert request, the device displays a message indicating that your contact has started navigating to your location.

After receiving the alert, your contacts can navigate to your location.

Sending a Message to Your Contacts

You can send and receive automated messages. There are 18 messages choose from, such as "Help" and "I'm Coming."

- 1 Select  > **Contacts** > **Message**.
- 2 Select a message.

The message is sent to your contacts with your name before the message. Anyone tracking your handheld device receives the message.

Tracking a Contact

You can keep track of contacts' locations using the map.

Select .

Finding Your Contact ID

Select **Setup** > **Contacts** > **Pairing Setup**.

The contact ID for your handheld device is listed under ID.

Changing Your Contact ID

If you are experiencing interference from other collars or handheld devices in the area, you might need to change the contact ID for your handheld device.



- 1 Select **Setup** > **Contacts** > **Pairing Setup** > **ID**.
- 2 Select a contact ID that is not yet assigned to another device in the area.

If you select a contact ID that interferes with devices in the area, you should select a new contact ID.

Each time a contact changes their contact ID, you must update the contact ID in your handheld device ([Updating a Contact ID, page 8](#)).

Updating a Contact ID

If a contact has changed their contact ID ([Changing Your Contact ID, page 8](#)), you can quickly update the contact ID in your handheld device.

- 1 Select  > **Contacts**.
- 2 Select the contact.
- 3 Select **Show Info**.
- 4 Select  > **Change ID**.
- 5 Select the contact ID that matches the contact's new contact ID.

Hunting with the Alpha System

You can perform many tasks that are very helpful when you are hunting with the Alpha system.

- Mark your truck's location ([Marking Your Truck Location, page 8](#)).
- Track your dogs ([Tracking Your Dog on the Map, page 5](#)).
- Track your fellow hunters ([Tracking a Contact, page 8](#)).
- Mark the location of a covey ([Marking a Covey, page 8](#)).
- Send messages to your fellow hunters ([Sending a Message to Your Contacts, page 8](#)).
- Turn on the collar light ([Turning On the Collar Light, page 8](#)).
- Put the collar into rescue mode to save battery power ([Turning On Rescue Mode, page 8](#)).
- Pause tracking while you move the dogs ([Pausing Dog Tracking, page 5](#)).

Marking Your Truck Location

You can mark the location of the truck, so you can navigate back to your truck after the hunt.

- 1 Select **New Hunt**.
- 2 Follow the on-screen instructions.

Marking a Covey

You can mark a covey location and enter the estimated number of birds flushed and the number of birds taken.

- 1 Select **Mark**.
- 2 Select **Covey**.
- 3 Enter the number of birds flushed.
- 4 Enter the number of birds taken.
- 5 Select **OK**.

Turning On the Collar Light

You can turn on the LEDs on the collar at night to help locate a dog or to warn drivers if a dog wanders near a road. The light is visible for up to 100 yards.

- 1 Select **Dog List**.
- 2 Select a dog.
- 3 Select **Show Info**.
- 4 Select  > **Adjust Collar Light**.
- 5 Select **Continuous**, **Blink Slow**, or **Blink Fast**.

TIP: Select different light setting for each dog to help you identify the dogs in the field.

Turning On Rescue Mode

You can turn on rescue mode to conserve battery power at the end of a long hunt or if your dog might get out of range.

- 1 Select **Dog List**.
- 2 Select a dog.
- 3 Select **Show Info** >  > **Rescue Mode**.

After you have turned on rescue mode, it stays on until you turn it off.

When the collar battery power falls below 25%, the collar data updates only once every 2 minutes.

Waypoints, Routes, and Tracks



Waypoints

Waypoints are locations you record and store in the device.

Marking Your Current Location



- 1 Select **Mark**.
- 2 Select an option:
 - Select **New**.
 - Select a default location name, such as **Truck** or **Camp**.
- 3 Select **Save**.

Marking a Waypoint Using the Map

- 1 Select .
- 2 Select the location on the map.
- 3 Select the information bar along the top of the screen.
- 4 Select  > **OK**.



Editing a Waypoint

Before you can edit a waypoint, you must create a waypoint.

- 1 Select  > **Waypoint Manager**.
- 2 Select a waypoint.
- 3 Select an item to edit, such as the name.
- 4 Enter the new information.
- 5 Select .



Repositioning a Waypoint to Your Current Location

You can change the position of a waypoint. For example, if you move your vehicle, you can change the location to your current position.

- 1 Select  > **Waypoint Manager**.
- 2 Select a waypoint.
- 3 Select  > **Reposition Here**.



The waypoint location changes to your current location.

Moving a Waypoint on the Map

- 1 Select  > **Waypoint Manager**.
- 2 Select a waypoint.
- 3 Select  > **Move Waypoint**.
- 4 Select the new location on the map.
- 5 Select **Move**.

Increasing the Accuracy of a Waypoint Location





You can refine a waypoint location for more accuracy. When averaging, the device takes several readings at the same location and uses the average value to provide more accuracy.

- 1 Select  > **Waypoint Manager**.
- 2 Select a waypoint.
- 3 Select  > **Average Location**.
- 4 Move to the waypoint location.
- 5 Select **Start**.
- 6 Follow the on-screen instructions.
- 7 When the confidence status bar reaches 100%, select **Save**.



For best results, collect 4 to 8 samples for the waypoint, waiting at least 90 minutes between samples.

Projecting a Waypoint

You can create a new location by projecting the distance and bearing from a marked location to a new location.

- 1 Select  > **Waypoint Manager**.
- 2 Select a waypoint.
- 3 Select  > **Project Waypoint**.
- 4 Enter the bearing, and select .
- 5 Select a unit of measure.
- 6 Enter the distance, and select .
- 7 Select **Save**.

Deleting a Waypoint

- 1 Select  > **Waypoint Manager**.
- 2 Select a waypoint.
- 3 Select  > **Delete** > **Yes**.

Routes

A route is a sequence of waypoints or locations that leads you to your final destination.

Creating a Route

- 1 Select  > **Route Planner** > **Create Route** > **Select First Point**.
- 2 Select a category.
- 3 Select the first point on the route.
- 4 Select **Use** > **Select Next Point**.
- 5 Select a point.
- 6 Repeat steps 3 through 6 to add all the points in the route.

Editing the Name of a Route

- 1 Select  > **Route Planner**.
- 2 Select a route.

- 3 Select **Change Name**.
- 4 Enter the new name, and select .

Navigating a Saved Route

- 1 Select  > **Route Planner**.
- 2 Select a route.
- 3 Select **View Map** > **Go**.
- 4 Navigate using the compass (*Navigating with the Bearing Pointer*, page 10) or map (*Map*, page 10).

Editing a Route

- 1 Select  > **Route Planner**.
- 2 Select a route.
- 3 Select **Edit Route**.
- 4 Select a point.
- 5 Select an option:
 - To view the point on the map, select **Review**.
 - To change the order of the points on the route, select **Move Up** or **Move Down**.
 - To insert an additional point on the route, select **Insert**.
The additional point is inserted before the point you are editing.
 - To remove the point from the route, select **Remove**.

Reversing a Route

- 1 Select  > **Route Planner**.
- 2 Select a route.
- 3 Select **Reverse Route**.

Viewing a Route on the Map

- 1 Select  > **Route Planner**.
- 2 Select a route.
- 3 Select **View Map**.

Viewing the Active Route

- 1 Select  > **Active Route**.
- 2 Select a point in the route to view additional details.

Deleting a Route

- 1 Select  > **Route Planner**.
- 2 Select a route.
- 3 Select **Delete Route** > **Yes**.

Tracks

A track is a recording of your path. The track log contains information about points along the recorded path, including time, location, and elevation for each point.

Recording Track Logs

- 1 Select  > **Setup** > **Tracks** > **Track Log**.
- 2 Select **Record**, **Do Not Show** or **Record, Show On Map**.
If you select **Record**, **Show On Map**, a line on the map indicates your track.
- 3 Select **Record Method**.
- 4 Select an option:
 - To record tracks at a variable rate that create an optimum representation of your tracks, select **Auto**.
 - To record tracks at a specified distance, select **Distance**.
 - To record tracks at a specified time, select **Time**.
- 5 Select **Interval**.
- 6 Complete an action:
 - If you selected **Auto** for the **Record Method**, select an option to record tracks more or less often.

NOTE: Using the Most Often interval provides the most track detail, but fills up the device memory quicker.

- If you selected **Distance** or **Time** for the **Record Method**, enter a value, and select ✓.

As you move with the device turned on, a track log is created.

Viewing Details about the Track

- 1 Select  > **Track Manager**.
- 2 Select a track.
- 3 Select **View Map**.

The beginning and the end of the track are marked by flags.

- 4 Select the information bar along the top of the screen. Information about the track is listed.

Viewing the Elevation Plot of a Track

- 1 Select  > **Track Manager**.
- 2 Select a track.
- 3 Select **Elevation Plot**.

Navigating to the Start of a Track

You can navigate back to the beginning of a track. This can be helpful when finding your way back to camp or the trail head.

- 1 Select  > **Track Manager** > **Current Track** > **View Map**.
- 2 Select **TracBack**.

The map page opens with your route marked with a magenta line.

- 3 Navigate using the map (*Map, page 10*) or the compass (*Navigating with the Bearing Pointer, page 10*).



Changing the Track Color

- 1 Select  > **Track Manager**.
- 2 Select a track.
- 3 Select **Set Color**.
- 4 Select a color.

Saving the Current Track

- 1 Select  > **Track Manager**.
- 2 Select a track.
- 3 Select an option:
 - To save the entire track, select **Save Track**.
 - To save part of the track, select **Save Portion**, and select the part to save.

Saving a Location on a Track

- 1 Select  > **Track Manager**.
- 2 Select a track.
- 3 Select **View Map**.
- 4 Select a location along the track.
- 5 Select the information bar along the top of the screen.
- 6 Select .
- 7 Select **OK**.

Clearing the Current Track

Select  > **Track Manager** > **Current Track** > **Clear Current Track**.

Deleting a Track

- 1 Select  > **Track Manager**.
- 2 Select a track.
- 3 Select **Delete** > **Yes**.

Archiving a Saved Track

You can archive saved tracks to save memory space.

- 1 Select  > **Track Manager**.

- 2 Select a saved track.

- 3 Select **Archive**.

Archiving Tracks Automatically

- 1 Select **Setup** > **Tracks** > **Auto Archive**.
- 2 Select an option.

Sending and Receiving Data Wirelessly

Before you can share data wirelessly, you must be within 10 feet (3 m) of a compatible Garmin device.

You can share waypoints, geocaches, routes, and tracks wirelessly.

- 1 Select  > **Share Wirelessly**.
- 2 Select **Send** or **Receive**.
- 3 Follow the on-screen instructions.

Navigation

You can navigate routes and tracks, to a waypoint, geocache, photo, or any saved location in the device. You can use the map or the compass to navigate to your destination.

Map

 represents your location on the map. As you travel, the icon moves and leaves a track log (trail). Waypoint names and symbols appear on the map. When you are navigating to a destination, your route is marked with a magenta line on the map.

When the map orientation is Track Up, objects on the map appear to rotate around your position. As you travel, the entire map reorients in the direction you are facing. You can stabilize the objects by setting the orientation to North Up (*Map Settings, page 13*).

To open the map, select .

Measuring Distance on the Map

You can measure the distance between two points.

- 1 From the map, select a location.
- 2 Select  > **Measure Distance** > **Use**.
- 3 Move the pin to another location on the map.

Compass

The handheld device has a 3-axis, tilt-compensated compass. You can use a bearing pointer or a course pointer to navigate to your destination.

Calibrating the Compass

NOTICE



Calibrate the electronic compass outdoors. To improve heading accuracy, do not stand near objects that influence magnetic fields, such as vehicles, buildings, and overhead power lines.

You should calibrate the compass after moving long distances, experiencing temperature changes, or removing the battery.

- 1 Select  > **Compass** >  > **Calibrate Compass** > **Start**.
- 2 Follow the on-screen instructions.

Navigating with the Bearing Pointer

When navigating to a destination,  points to your destination, regardless of the direction you are moving.

- 1 While navigating to a destination, select  > **Compass**.
- 2 Turn until  points toward the top of the compass, and continue moving in that direction to the destination.

Course Pointer

The course pointer is most useful if you are navigating on water or where there are no major obstacles in your path. It also helps you avoid hazards to either side of the course, such as shoals or submerged rocks.

To enable the course pointer, from the compass, select **≡ > Setup Heading > Go To Line/Pointer > Course (CDI)**.

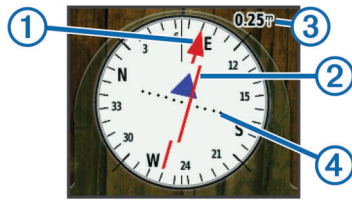

The course pointer ① indicates your relationship to the course line leading to the destination. The course deviation indicator (CDI) ② provides the indication of drift (right or left) from the course. The scale ③ refers to the distance between dots ④ on the course deviation indicator, which tell you how far off course you are.

Where To? Menu

You can use the Where To? menu to find a destination to navigate to. Not all Where To? categories are available in all areas and maps.

Finding a Waypoint by Name

- 1 Select **▲ > Where To? > Waypoints > ≡ > Spell Search**.
- 2 Enter the name.
- 3 Select **✓**.

Finding a Waypoint Near Another Waypoint

- 1 Select **▲ > Waypoint Manager**.
- 2 Select a waypoint.
- 3 Select **≡ > Find Near Here**.
- 4 Select a category.

The list displays waypoints near the original waypoint.

Navigating with Sight 'N Go

You can point the device at an object in the distance, lock in the direction, and navigate to the object.

- 1 Select **▲ > Sight 'N Go**.
- 2 Point the device at an object.
- 3 Select **Lock Direction > Set Course**.
- 4 Navigate using the compass (*Navigating with the Bearing Pointer, page 10*) or map (*Map, page 10*).

Elevation Plot

By default, the elevation plot displays the elevation for an elapsed time. You can customize the plot (*Changing the Plot Type, page 11*) and the data fields (*Customizing the Data Fields, page 12*).

To open the elevation plot, select **▲ > Elevation Plot**.

Calibrating the Barometric Altimeter

You can manually calibrate the barometric altimeter if you know the correct elevation or the correct barometric pressure.

- 1 Go to a location where the elevation or barometric pressure is known.
- 2 Select **▲ > Elevation Plot > ≡ > Calibrate Altimeter**.
- 3 Follow the on-screen instructions.

Navigating to a Point on the Plot

- 1 Select **▲ > Elevation Plot**.

- 2 Select an individual point on the plot.

Details about the point appear in the upper-left corner of the plot.

- 3 Select **≡ > View Map**.

- 4 Select the information bar along the top of the screen.

- 5 Select **Go**.

- 6 Navigate using the compass (*Navigating with the Bearing Pointer, page 10*) or map (*Map, page 10*).

Changing the Plot Type

You can change the elevation plot to display pressure and elevation over time or distance.

- 1 Select **▲ > Elevation Plot > ≡ > Change Plot Type**.
- 2 Select an option.

Resetting the Elevation Plot

Select **▲ > Elevation Plot > ≡ > Reset > Clear Current Track > Yes**.

Trip Computer

The trip computer displays your current speed, average speed, maximum speed, trip odometer, and other helpful statistics. You can customize the trip computer layout, dashboard, and data fields (*Customizing the Data Fields, page 12*).

To open the trip computer, select **▲ > Trip Computer**.

Resetting the Trip Computer

For accurate trip information, reset the trip information before beginning a trip.

Select **▲ > Trip Computer > ≡ > Reset > Reset Trip Data > Yes**.

Applications

Setting a Proximity Alarm

Proximity alarms alert you when you or your dogs are within a specified range of a particular location. A tone sounds when you enter the designated radius.

- 1 Select **▲ > Proximity Alarms**.
- 2 Select **Create Alarm**.
- 3 Select a category.
- 4 Select a location.
- 5 Select **Use**.
- 6 Enter a radius.

When you enter an area with a proximity alarm, the device sounds a tone.

Calculating the Size of an Area

- 1 Select **▲ > Area Calculation > Start**.
- 2 Walk around the perimeter of the area you want to calculate.
- 3 When finished, select **Calculate**.

Viewing the Calendar and Almanacs

You can view device activity, such as when a waypoint was saved, and almanac information for the sun and moon, and hunting and fishing.

- 1 Select **▲**.
- 2 Select an option:
 - To view device activity for specific days, select **Calendar**.
 - To view the sunrise, sunset, moonrise, and moonset times, select **Sun and Moon**.

- To view the predicted best times for hunting and fishing, select **Hunt and Fish**.

3 If necessary, select ◀ or ▶ to view a different day.

Setting an Alarm

- 1 Select ▲ > **Alarm Clock**.
- 2 Select + and - to set the time.
- 3 Select **Turn Alarm On**.
- 4 Select an option.

The alarm sounds at the selected time. If the device is off at the alarm time, the device turns on and sounds the alarm.

Opening the Stopwatch

Select ▲ > **Stopwatch**.

Satellite Page

The satellite page shows your current location, GPS accuracy, satellite locations, and signal strength.

Changing the Satellite View

By default, the satellite view is with North at the top. You can change the view of the satellites to be oriented with your current track toward the top of the screen.

- 1 Select ▲ > **Satellite** > ☰.
- 2 Select **Track Up**.

Turning Off GPS

Select ▲ > **Satellite** > ☰ > **Use With GPS Off**.

Simulating a Location

- 1 Select ▲ > **Satellite** > ☰ > **Use With GPS Off**.
- 2 Select ☰ > **Set Location On Map**.
- 3 Select a location.
- 4 Select **Use**.

VIRB® Remote

The VIRB remote function allows you to control your VIRB action camera using your device. Go to www.garmin.com/VIRB to purchase a VIRB action camera.

Controlling a VIRB Action Camera with Your Handheld Device

Before you can use the VIRB remote function on your handheld device, you must enable the remote setting on your VIRB camera. See the owner's manual for your VIRB camera for more information.

- 1 Turn on your VIRB camera.
- 2 From your handheld device, select ▲ > **VIRB Remote**.
- 3 Wait while the handheld device connects to your VIRB camera.
- 4 Select an option:
 - To start and stop recording video, select **REC**.
 - To take a photo, select 📷.

Customizing Your Device

Customizing the Main Menu

You can move, add, and delete items in the main menu.

- 1 From the main menu, select **Setup** > **Main Menu**.
- 2 Select a menu item.
- 3 Select an option:
 - Select **Move Up** or **Move Down** to change the location of the item in the list.

- Select **Remove** to delete an item from the list.
- Select **Add Page** to place an item on the list after you have removed it.
- Select ☰ > **Restore Defaults** to reset the order of all items in the menu.

Customizing the Data Fields

Before you can customize the data fields on the map, you must enable the data fields (*Enabling the Map Data Fields, page 12*).

You can customize the data fields and dashboards of the map, compass, elevation plot, and trip computer.

- 1 Open the page for which you will change the data fields.
- 2 Select a data field to customize.
- 3 Select the new data field.

For data field descriptions, see *Data Field Options, page 19*.

Enabling the Map Data Fields

Select 📷 > ☰ > **Setup Map** > **Dashboard** > **Small Data Fields**.

System Settings

Select **Setup** > **System**.

GPS: Sets the GPS to Normal, WAAS/EGNOS (Wide Area Augmentation System/European Geostationary Navigation Overlay Service), or Demo Mode (GPS off). For more information about WAAS, go to <http://www.garmin.com/aboutGPS/waas.html>.

BaseCamp BaseStation: Sets how the device connects to BaseCamp when the device is connected to the computer.

Dog Settings

Select **Setup** > **Dogs**.

Dog Track On Map: Sets the length (duration in minutes or hours) of the dog track on the map. Reducing the duration of the track shown can reduce the clutter on the map.

Zoom Map To Dogs: Automatically zooms the map to show all of the dogs' locations and your location unless you manually pan the map.

Dog Alerts: Sets how you are alerted to certain actions (*Setting Dog Alerts, page 4*).

Bark Detection: Enables the bark detection feature. This feature is not available in all areas.

Contact Settings

Select **Setup** > **Contacts**.

Contact Track On Map: Sets the length (duration in minutes or hours) of the contact track on the map.

Zoom Map To Contacts: Automatically zooms the map to show all of the contacts' locations and your location unless you manually pan the map.

Message Alerts: Sets message alerts to Tone, Vibrate, Tone and Vibrate, or Message Only.

Pairing Setup: Sets the options your device uses to track and communicate with other devices.

Display Settings

Select **Setup** > **Display**.

Backlight Timeout: Adjusts the length of time before the backlight turns off.

Screen Capture: Allows you to save the image on the device screen.

Battery Save: Saves the battery power and prolongs the battery life by turning off the screen when the backlight times out (*Turning On the Handheld Battery Save Mode, page 15*).

Calibrate Screen: Aligns the screen to properly respond to touches (*Calibrating the Touchscreen*, page 13).

Calibrating the Touchscreen

You can calibrate the screen, if it does not seem to be responding properly.

- 1 Select **Setup > Display > Calibrate Screen**.
- 2 Follow the on-screen instructions.

Appearance Settings

Select **Setup > Appearance**.

Mode: Sets a light background, a dark background, or automatically switches between the two based on the sunrise and sunset time for your current location.

Background: Sets the background image.

Day Highlight Color: Sets the color for selections made when in day mode.

Night Highlight Color: Sets the color for selections made when in night mode.

Setting the Device Tones

You can customize tones for messages, keys, warnings, and alarms.

- 1 Select **Setup > Tones**.
- 2 Select a tone for each audible type.

Map Settings

Select **Setup > Map**.

Orientation: Adjusts how the map is shown on the page. North Up shows north at the top of the page. Track Up shows your current direction of travel toward the top of the page. Automotive Mode shows an automotive perspective with the direction of travel at the top.

Guidance Text: Sets when the guidance text on the map is shown.

Dashboard: Sets a dashboard to display on the map. Each dashboard shows different information about your route or your location.

Map Information: Enables or disables the maps currently loaded on the device.

Map Speed: Adjusts the speed at which the map is drawn. A faster map drawing speed decreases the battery life.

Advanced Map Settings

Select **Setup > Map > Advanced Setup**.

Auto Zoom: Automatically sets the zoom level for optimal use of your map. When Off is selected, you must zoom in or out manually.

Detail: Sets the amount of detail shown on the map. Showing more detail may cause the map to redraw more slowly.

Shaded Relief: Shows detail relief on the map (if available) or turns off shading.

Vehicle: Allows you to select a position icon, which represents your position on the map.

Zoom Levels: Sets the zoom level at which map items will appear. Map items do not appear when the map zoom level is higher than the selected level.

Text Size: Sets the text size for map items.

Track Settings

Select **Setup > Tracks**.

Track Log: Turns track recording on or off.

Record Method: Sets a track recording method. Auto records the tracks at a variable rate to create an optimum representation of your tracks.

Interval: Sets a track log recording rate. Recording points more frequently creates a more-detailed track, but fills the track log faster.

Auto Archive: Sets an automatic archive method to organize your tracks. Tracks are saved and cleared automatically based on the user setting.

Color: Sets the color of the track line on the map.

Routing Settings

The device calculates routes optimized for the type of activity you are doing. The routing settings available vary based on the activity selected.

Select **Setup > Routing**.

Activity: Sets an activity for routing. The device calculates routes optimized for the type of activity you are doing.

Route Transitions: Sets how the device routes from one point on the route to the next. This setting is available only for some activities. Distance routes you to the next point on the route when you are within a specified distance of your current point.

Lock On Road: Locks the position icon, which represents your position on the map, onto the nearest road.

Changing the Units of Measure

You can customize units of measure for distance and speed, elevation, depth, temperature, and pressure.

- 1 Select **Setup > Units**.
- 2 Select a measurement type.
- 3 Select a unit of measure for the setting.

Time Settings

Select **Setup > Time**.

Time Format: Sets the device to show time in a 12-hour or 24-hour format.

Time Zone: Sets the time zone for the device. Automatic sets the time zone automatically based on your GPS position.

Position Format Settings

NOTE: Do not change the position format or the map datum coordinate system unless you are using a map or chart that specifies a different position format.

Select **Setup > Position Format**.

Position Format: Sets the position format for the location information.

Map Datum: Sets the coordinate system on which the map is structured.

Map Spheroid: Shows the coordinate system the device is using. The default coordinate system is WGS 84.

Heading Settings

You can customize the compass settings.

Select **Setup > Heading**.

Display: Sets the type of directional heading shown on the compass.

North Reference: Sets the north reference used on the compass.

Go To Line/Pointer: Sets the behavior of the pointer that appears on the map. Bearing points in the direction of your destination. Course (CDI) shows your relationship to the course line leading to the destination.

Compass: Automatically switches from an electronic compass to a GPS compass when you are traveling at a higher rate of speed for a period of time.

Calibrate Compass: Calibrates the compass ([Calibrating the Compass](#), page 10).

Altimeter Settings

Select **Setup > Altimeter**.

Auto Calibration: Automatically calibrates the altimeter each time the device is turned on.

Barometer Mode: Sets how the device measures barometric information. Variable Elevation allows the barometer to measure changes in elevation while you are moving. Fixed Elevation assumes the device is stationary at a fixed elevation, so the barometric pressure should change only due to weather.

Pressure Trending: Sets how the device records pressure data. Save Always records all pressure data, which can be helpful when you are watching for pressure fronts.

Plot Type: Sets the type of data recorded and displayed in the plot. Records elevation changes over a period of time or distance, records barometric pressure over a period of time, or records ambient pressure changes over a period of time.

Calibrate Altimeter: Calibrates the altimeter.

Marine Map Settings

Select **Setup > Marine**.

Marine Chart Mode: Sets the type of chart the device uses. Nautical displays various map features in different colors so the marine POIs are more readable and so the map reflects the drawing scheme of paper charts. Fishing (requires marine maps) displays a detailed view of bottom contours and depth soundings and simplifies map presentation for optimal use while fishing.

Appearance: Sets the appearance of marine navigation aids on the map.

Marine Alarm Setup: Sets alarms for when you exceed a specified drift distance while anchored, when you are off course by a specified distance, and when you enter water of a specific depth.

Device Information

Viewing Device Information

You can view the unit ID, software version, and license agreement.

Select **Setup > About**.

Support and Updates

- You can update software and maps for your handheld device using Garmin Express™.
- You can update software for your dog collar device using Garmin WebUpdater.

Support and Updates

Garmin Express (www.garmin.com/express) provides easy access to these services for Garmin devices.

- Product registration
- Product manuals
- Software updates
- Map, chart, or course updates

Setting Up Garmin Express

- 1 Connect the device to your computer using a USB cable.
- 2 Go to www.garmin.com/express.

- 3 Follow the on-screen instructions.

Updating the Software

Before you can update the handheld device or collar software, you must connect the handheld device ([Connecting the Handheld Device to a Computer](#), page 16) or the collar ([Connecting the Collar to a Computer](#), page 16) to the computer.

You must update the software on the handheld device and collar separately.

NOTE: Updating the software does not erase any of your data or settings.

- 1 Go to www.garmin.com/products/webupdater.
- 2 Follow the on-screen instructions.

Device Care

NOTICE

Do not store the device where prolonged exposure to extreme temperatures can occur, because it can cause permanent damage.

Never use a hard or sharp object to operate the touchscreen, or damage may result.

Avoid chemical cleaners, solvents, and insect repellents that can damage plastic components and finishes.

Secure the weather cap tightly to prevent damage to the USB port.

Cleaning the Device

NOTICE

Even small amounts of sweat or moisture can cause corrosion of the electrical contacts when connected to a charger. Corrosion can prevent charging and data transfer.

- 1 Wipe the device using a cloth dampened with a mild detergent solution.
- 2 Wipe it dry.

After cleaning, allow the device to dry completely.

Cleaning the Touchscreen

- 1 Use a soft, clean, lint-free cloth.
- 2 If necessary, lightly dampen the cloth with water.
- 3 If using a dampened cloth, turn off the device and disconnect the device from power.
- 4 Gently wipe the screen with the cloth.

Specifications

Alpha 100 Handheld Device Specifications

Battery type	Rechargeable, replaceable lithium-ion
Battery life	Up to 20 hr.
Operating temperature range	From -4° to 140°F (from -20° to 60°C)
Charging temperature range	From 32° to 104°F (from 0° to 40°C)
Long-term storage temperature range	From 32° to 77°F (from 0° to 25°C)
VHF wireless range	Up to 9 mi.
ANT+ low power wireless range	About 3 m (10 ft.)
Wireless frequencies/ protocols	155 MHz @ 31.75 dBm nominal, 2.4 GHz @ 1.82 dBm nominal
Water rating	IEC 60529 IPX7 ¹

¹ The device withstands incidental exposure to water of up to 1 m for up to 30 min. For more information, go to www.garmin.com/waterrating.

TT 15 Dog Collar Device Specifications

Battery type	Rechargeable, replaceable lithium-ion
Battery life	From 20 to 40 hr. Battery life is determined by the handheld device in use.
Operating temperature range	From -20° to 60°C (from -4° to 140°F)
Charging temperature range	From 0° to 40°C (from 32° to 104°F)
ANT ^o wireless range	Up to 10 m (32.8 ft.)
VHF radio range	Up to 14.48 km (9 mi.)
Wireless frequencies/ protocols	155 MHz @ 32.15 dBm nominal, 2.4 GHz @ 6.16 dBm nominal
Water rating	1 ATM ¹

TT 15 mini Dog Collar Device Specifications

Battery type	Rechargeable, replaceable lithium-ion
Battery life	Up to 16 to 30 hr., typical use
Operating temperature range	From -20° to 60°C (from -4° to 140°F)
Charging temperature range	From 5° to 40°C (from 41° to 104°F)
ANT wireless range	Up to 5 m (16.4 ft.)
VHF radio range	Up to 6.44 km (4 mi.)
Wireless frequencies/ protocols	155 MHz @ 32.77 dBm nominal, 2.4 GHz @ -1.7 dBm nominal
Water rating	1 ATM ¹

Battery Information

WARNING

This product contains a lithium-ion battery. To prevent the possibility of personal injury or product damage caused by battery exposure to extreme heat, store the device out of direct sunlight.

Do not use a sharp object to remove batteries.

CAUTION

Contact your local waste disposal department to properly recycle the batteries.

Long-Term Storage

NOTICE

The normal long-term decrease in the charging capacity of lithium-ion batteries can be accelerated by exposure to elevated temperatures. Storing a fully charged device in a location with a temperature outside the long-term storage temperature range can significantly reduce its recharging capacity.

When you do not plan to use the handheld device for several months, the battery should be removed. Stored data is not lost when the battery is removed.

When you do not plan to use the collar for several months, the battery should be charged to about 50%. The device should be stored in a cool, dry place with temperatures around the typical household level. After storage, the collar should be fully recharged before use.

Maximizing the Battery Life

You can do several things to extend the life of the batteries in the handheld device and collar.

- Reduce the backlight brightness (*Adjusting the Backlight Brightness*, page 15).

- Reduce the backlight timeout (*Adjusting the Backlight Timeout*, page 15).
- Select a longer duration for your handheld update rate (*Changing Your Handheld Update Rate*, page 15).
- Turn off the transmitter (*Turning Off the Transmitter*, page 16).
- Use battery save mode (*Turning On the Handheld Battery Save Mode*, page 15)
- Decrease the map drawing speed (*Adjusting the Map Drawing Speed*, page 15).
- Put the dog collar device into rescue mode (*Turning On Rescue Mode*, page 8) to conserve the collar battery.
- Extend the duration for the collar update rate (*Changing the Dog Collar Device Update Rate*, page 15) to conserve the collar battery.

Adjusting the Backlight Brightness

Extensive use of screen backlighting can significantly reduce battery life. You can adjust the backlight brightness to maximize the battery life.

NOTE: The backlight brightness may be limited when the battery is low.

- 1 Select .
- 2 Use the slider bar to adjust the backlight brightness.

The device may feel warm when the backlight setting is high.

Adjusting the Backlight Timeout

You can decrease the backlight timeout to maximize the battery life.

- 1 Select **Setup > Display > Backlight Timeout**.
- 2 Select an option.

Changing the Dog Collar Device Update Rate

Before you can change the collar update rate, the collar must be turned on and within range of the handheld device.

You can select a longer duration for the update rate to conserve battery power.

- 1 Select **Dog List**.
- 2 Select a dog.
- 3 Select **Show Info >  > Change Update Rate**.

Changing Your Handheld Update Rate

You can select a longer duration for the update rate to conserve battery power.

- 1 Select **Setup > Contacts > Pairing Setup > Update Rate**.
- 2 Select a new update rate.

Turning On the Handheld Battery Save Mode

You can use battery save mode to prolong the battery life.

Select **Setup > Display > Battery Save > On**.

When in battery save mode, the screen shuts off when the backlight times out.

Adjusting the Map Drawing Speed

You can reduce the map drawing speed to conserve battery power.

Select **Setup > Map > Map Speed > Normal**.

Turning On the Transmitter

Before you can add a contact or initiate an emergency alert, you must ensure the transmitter is enabled.

NOTE: In cold temperatures, if you transmit when the battery is low, the device may shut down.

Select **Setup > Contacts > Pairing Setup > Transmitting > On**.

¹ The device withstands pressure equivalent to a depth of 10 m. For more information, go to www.garmin.com/waterrating.

Turning Off the Transmitter

You can disable transmitting to conserve battery power on the handheld device when you are not communicating with contacts.

NOTE: At cold temperatures, if you transmit when the battery is low, the device may shutdown.

Select **Setup > Contacts > Pairing Setup > Transmitting > Off**.

When the transmitter is off, you cannot send your location or messages to contacts.

Saving Energy While Charging the Device

You can turn off the device display and all other features while charging.

- 1 Connect your device to an external power source.
The remaining battery capacity appears.
- 2 Hold the power key for 4 to 5 seconds.
The display turns off, and the device goes into a low power, battery charging mode.
- 3 Charge the device completely.

Data Management

You can store files on your device. The device has a memory card slot for additional data storage.

NOTE: The device is not compatible with Windows® 95, 98, Me, Windows NT®, and Mac® OS 10.3 and earlier.

File Types

The handheld device supports these file types.

- Files from BaseCamp. Go to www.garmin.com/trip_planning.
- JPEG photo files.
- GPX geocache files. Go to www.geocaching.com/play.
- GPI custom POI files from the Garmin POI Loader. Go to www.garmin.com/products/poiloader.

Installing a Memory Card

⚠ WARNING

Do not use a sharp object to remove user-replaceable batteries.

You can install a microSD memory card in the handheld device for additional storage or pre-loaded maps.

- 1 Turn the D-ring counter-clockwise, and pull up to remove the cover.
- 2 Remove the battery.
- 3 Slide the card holder to the left and lift up.



- 4 Place the memory card with the gold contacts facing down.
- 5 Close the card holder.
- 6 Slide the card holder to the right to lock it.
- 7 Replace the battery and cover.

Connecting the Handheld Device to a Computer

NOTICE

To prevent corrosion, thoroughly dry the USB port, the weather cap, and the surrounding area before charging or connecting to a computer.

- 1 Lift the weather cap ①.



- 2 Plug the small end of the USB cable into the mini-USB connector ② on the device.
- 3 Plug the other end of the USB cable into an available USB port on the computer.
Your device and memory card (optional) appear as removable drives in My Computer on Windows computers and as mounted volumes on Mac computers.

Connecting the Collar to a Computer

NOTICE

To prevent corrosion, you should dry the contacts on the collar and the surrounding area before connecting the charging clip.

You can connect the collar to your computer to use with programs like BaseCamp. The collar is not a mass storage device.

- 1 Snap the charging clip onto the collar.
- 2 Plug the small end of the USB cable into the mini-USB port on the charging clip cable.
- 3 Plug the other end of the USB cable into a USB port on the computer.

Transferring Dog Tracks to BaseCamp

You can transfer the dog tracks to BaseCamp.

- 1 Connect the collar to the computer ([Connecting the Collar to a Computer, page 16](#)).
The collar turns on automatically.
- 2 Select ⏻.
- 3 Open BaseCamp.
BaseCamp recognizes and transfers the collar's internal track log.

Deleting Files

NOTICE

If you do not know the purpose of a file, do not delete it. Your device memory contains important system files that should not be deleted.

- 1 Open the **Garmin** drive or volume.
- 2 If necessary, open a folder or volume.
- 3 Select a file.
- 4 Press the **Delete** key on your keyboard.

Disconnecting the USB Cable

If your device is connected to your computer as a removable drive or volume, you must safely disconnect your device from your computer to avoid data loss. If your device is connected to your Windows computer as a portable device, it is not necessary to safely disconnect.

- 1 Complete an action:
 - For Windows computers, select the **Safely Remove Hardware** icon in the system tray, and select your device.
 - For Mac computers, drag the volume icon to the trash.
- 2 Disconnect the cable from your computer.

Appendix

Accessories and Replacement Parts

Purchasing Accessories

Go to <http://buy.garmin.com>.

Optional Maps

You can use additional maps with the device, such as BirdsEye satellite imagery, BlueChart® g2, and City Navigator® detailed maps. Detailed maps may contain additional points of interest, such as restaurants or marine services. For more information, go to <http://buy.garmin.com> or contact your Garmin dealer.

ANT+ Sensors

Your device can be used with wireless ANT+ sensors. For more information about compatibility and purchasing optional sensors, go to <http://buy.garmin.com>.

tempe™

The tempe is an ANT+ wireless temperature sensor. You can attach the sensor to a secure strap or loop where it is exposed to ambient air, and therefore, provides a consistent source of accurate temperature data. You must pair the tempe with your device to display temperature data from the tempe.

Using Optional Fitness Accessories

- 1 Bring the device within range 10 feet (3 m) of the ANT+ accessory.
- 2 Select **Setup > ANT Sensors**.
- 3 Select **Heart Rate Monitor, Bike Cadence Sensor, or tempe Sensor**.
- 4 Select **On, Off, or Search for New**.
- 5 Customize the data fields to view the heart rate or cadence data ([Customizing the Data Fields, page 12](#)).

Tips for Pairing ANT+ Accessories with Your Garmin Device

- Verify that the ANT+ accessory is compatible with your Garmin device.
- Before you pair the ANT+ accessory with your Garmin device, move 10 m (32.9 ft.) away from other ANT+ accessories.
- Bring the Garmin device within range 3 m (10 ft.) of the ANT+ accessory.
- After you pair the first time, your Garmin device automatically recognizes the ANT+ accessory each time it is activated. This process occurs automatically when you turn on the Garmin device and only takes a few seconds when the accessories are activated and functioning correctly.
- When paired, your Garmin device receives data from only your accessory, and you can go near other accessories.

TT 15 Battery Replacement Instructions

TT 15 Components

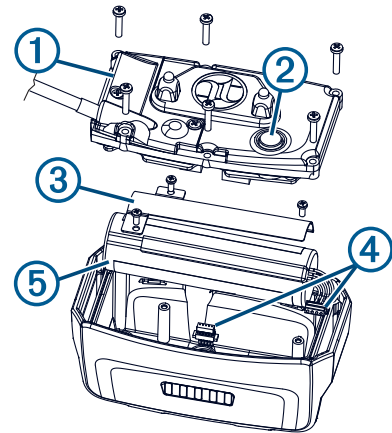

①	Back plate
②	Power key
③	Battery cover
④	Connectors
⑤	Battery

Removing the Old Battery

Before you replace the battery, you must remove all dirt, water, and debris from the device. You must also have a small Phillips screwdriver.

- 1 Remove the six screws from the outer edges of the back plate.
NOTE: You should leave the two inner screws in place.
- 2 Pry off the back plate.
- 3 Disconnect the battery connector and power connector.
- 4 Remove the screws that secure the battery cover.
- 5 Remove the battery cover and the battery.

Remember the orientation of the battery. You must install the new battery the same way.

After you remove the old battery, contact your local waste disposal department to properly recycle the battery.

Installing the New Battery

Before you replace the battery, you must remove the old battery ([Removing the Old Battery, page 17](#)). You also must have a small Phillips screwdriver. You may need a small flat screwdriver.

- 1 Install the new battery using the same orientation as the old battery.

The connector ① should face the end nearest the power key, and the bump ② where the wires connect to the battery should face toward the side with the charging clip contacts.

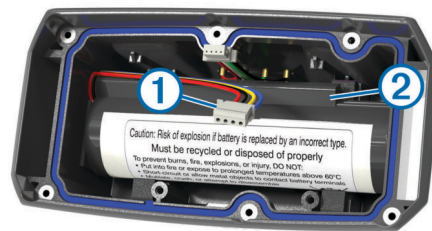

- 2 Replace the battery cover.
- 3 Replace the screws to secure the battery cover.
- 4 Connect the battery connector and power connector.

You may need to use a flat screwdriver to help secure the connectors.

- 5 Select the power key to test the connections.
When properly connected, a tone is emitted and the status LED blinks green.
- 6 Turn off the device.
- 7 Verify the gasket located inside the bottom cover is fully seated.
- 8 Replace the back plate.
- 9 Replace the six screws to secure the back plate.

After you install the new battery, charge the collar completely.

Replacing the Dog Collar Device Battery

Before you can replace the battery, you must remove all dirt, water, and debris from the device. You also need a small Phillips screwdriver and the security screwdriver included in the battery replacement kit.

- 1 Remove the screws from the L-shaped cover over the VHF antenna.
- 2 Pry off the L-shaped cover.
- 3 Remove the screws from the outer edges of the back plate.
- 4 Pry off the back plate.
- 5 Grip the battery connector wires close to the connector, and pull the connector perpendicular to the circuit board to disconnect the battery connector from the device.
- 6 Grip the power connector wires close to the connector, and pull the connector parallel to the circuit board to disconnect the power connector from the device.
- 7 Remove the screws from the battery plate.
- 8 Remove the battery plate.
- 9 Remove the battery.

The battery fits tightly. It may be necessary to pry the battery out of the back plate using a non-sharp, non-metal object.

- 10 Install the new battery into the front enclosure with the label side of the battery facing up, and the leading edge of the battery placed under the charging contact ledge of the device.
- 11 Replace the battery plate, and replace and tighten the two screws.

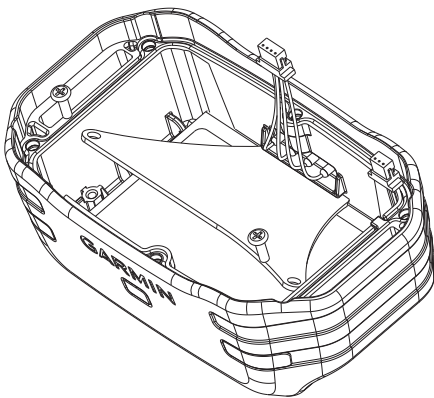

- 12 Verify the gasket is not damaged and is completely seated in the groove.
- 13 Connect the battery connector and the power connector to the device.
When properly installed, the connector plugs snap into the ports.
- 14 Replace the back plate, and replace and tighten the screws to secure the back plate.

15 Replace the L-shaped cover, and replace and tighten the screws to secure the L-shaped plate.

16 Verify the gasket is not sticking out of the device.

Replacing the Collar Strap

Before you replace the collar strap, you must remove all dirt, water, and debris from the device ([Cleaning the Device](#), page 14).

- 1 Pull the collar strap out of the GPS antenna, VHF antenna guide, and the dog device.
You may need to push and pull the collar strap to properly remove it. You may need to loosen the screw on the GPS antenna case, but do not remove them.
- 2 Thread the new collar strap through the dog device, VHF antenna guide, and GPS antenna.
- 3 If necessary, tighten the screws that secure the GPS antenna case.

Replacing the VHF Antenna in the Dog Collar Device

NOTICE

Do not excessively bend the band that connects the main device case with the GPS antenna.

When the L-shaped cover is removed, do not disturb the sealant opposite the VHF antenna, because this can damage the waterproof seal of the dog collar device.

Before you replace the VHF antenna, you must remove all dirt, water, and debris from the device ([Cleaning the Device](#), page 14). Also, you need a small Phillips screwdriver.

- 1 Remove the 4 screws ① from the L-shaped cover over the VHF antenna.
NOTE: You should note the location of the one short screw.
- 2 Pry off the L-shaped cover.

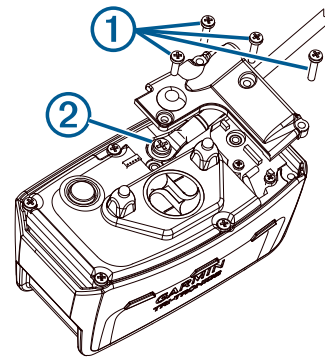

- 3 Remove the screw ② securing the VHF antenna to the back plate.
- 4 Pull the length of the antenna from the antenna guide to remove the old antenna.
- 5 Loop the antenna guide around the collar strap, and thread the new VHF antenna through the guide.
This helps to point the antenna up.
- 6 Replace the screw securing the VHF antenna to the back plate.
- 7 Replace the L-shaped cover over the VHF antenna.
- 8 Replace the 4 screws on the L-shaped cover, replacing the short screw in the correct location.

Changing the Fuse in the Vehicle Power Cable

NOTICE

When replacing the fuse, do not lose any of the small pieces and make sure they are put back in the proper position. The

vehicle power cable does not work unless it is assembled correctly.

If your device does not charge in your vehicle, you may need to replace the fuse located at the tip of the vehicle adapter.

- 1 Rotate the end piece ① 90 degrees counter clockwise to unlock it.



TIP: You may need to use a coin to remove the end piece.

- 2 Remove the end piece, the silver tip ②, and the fuse ③.
- 3 Insert a new fast-blow fuse that has the same current, such as 1 A or 2 A.
- 4 Place the silver tip in the end piece.
- 5 Push in the end piece and rotate it 90 degrees clockwise to lock it back into the vehicle power cable ④.

Data Field Options

Accuracy of GPS: The margin of error for your exact location. For example, your GPS location is accurate to within +/- 12 ft. (3.65 m).

Ambient Pressure: The uncalibrated environmental pressure.

Ascent - Average: The average vertical distance of ascent since the last reset.

Ascent - Maximum: The maximum rate of ascent in feet per minute or meters per minute since the last reset.

Ascent - Total: The total elevation distance ascended since the last reset.

Barometer: The calibrated current pressure.

Battery Level: The remaining battery power.

Bearing: The direction from your current location to a destination. You must be navigating for this data to appear.

Cadence: The number of revolutions of the crank arm or number of strides per minute. Your device must be connected to a cadence accessory for this data to appear.

Course: The direction from your starting location to a destination. Course can be viewed as a planned or set route. You must be navigating for this data to appear.

Descent - Average: The average vertical distance of descent since the last reset.

Descent - Maximum: The maximum rate of descent in feet per minute or meters per minute since the last reset.

Descent - Total: The total elevation distance descended since the last reset.

Distance to Destination: The remaining distance to the final destination. You must be navigating for this data to appear.

Distance to Next: The remaining distance to the next waypoint on the route. You must be navigating for this data to appear.

Elevation: The altitude of your current location above or below sea level.

Elevation - Maximum: The highest elevation reached since the last reset.

Elevation - Minimum: The lowest elevation reached since the last reset.

ETA at Destination: The estimated time of day when you will reach the final destination (adjusted to the local time of the destination). You must be navigating for this data to appear.

ETA at Next: The estimated time of day when you will reach the next waypoint on the route (adjusted to the local time of the waypoint). You must be navigating for this data to appear.

Glide Ratio: The ratio of horizontal distance traveled to the change in vertical distance.

Glide Ratio to Dest: The glide ratio required to descend from your current position to the destination elevation. You must be navigating for this data to appear.

GPS Signal Strength: The strength of the GPS satellite signal.

Heading: The direction you are moving.

Heart Rate: Your heart rate in beats per minute (bpm). Your device must be connected to a compatible heart rate monitor.

Location (lat/lon): The current position in latitude and longitude regardless of the selected position format setting.

Location (selected): The current position using the selected position format setting.

Odometer: A running tally of distance traveled for all trips. This total does not clear when resetting the trip data.

Off Course: The distance to the left or right by which you have strayed from the original path of travel. You must be navigating for this data to appear.

Pointer: An arrow points in the direction of the next waypoint or turn. You must be navigating for this data to appear.

Speed: The current rate of travel.

Speed Limit: The reported speed limit for the road. Not available in all maps and in all areas. Always rely on posted road signs for actual speed limits.

Speed - Maximum: The highest speed reached since the last reset.

Speed - Moving Avg.: The average speed while moving since the last reset.

Speed - Overall Avg.: The average speed while moving and stopped since the last reset.

Sunrise: The time of sunrise based on your GPS position.

Sunset: The time of sunset based on your GPS position.

Time of Day: The current time of day based on your current location and time settings (format, time zone, daylight saving time).

Time to Destination: The estimated time remaining before you reach the destination. You must be navigating for this data to appear.

Time to Next: The estimated time remaining before you reach the next waypoint in the route. You must be navigating for this data to appear.

To Course: The direction in which you must move to get back on the route. You must be navigating for this data to appear.

Trip Odometer: A running tally of the distance traveled since the last reset.

Trip Time - Moving: A running tally of the time spent moving since the last reset.

Trip Time - Stopped: A running tally of the time spent not moving since the last reset.

Trip Time - Total: A running tally of the total time spent moving and not moving since the last reset.

Turn: The angle of difference (in degrees) between the bearing to your destination and your current course. L means turn left. R means turn right. You must be navigating for this data to appear.

Velocity Made Good: The speed at which you are closing on a destination along a route. You must be navigating for this data to appear.

Vertical Speed: The rate of ascent or descent over time.

Vertical Speed to Dest: The rate of ascent or descent to a predetermined altitude. You must be navigating for this data to appear.

Waypoint at Dest: The last point on the route to the destination.
You must be navigating for this data to appear.

Waypoint at Next: The next point on the route. You must be
navigating for this data to appear.

Index

- A**
 - accessories 1, 17
 - alarms
 - clock 12
 - marine 14
 - proximity 11
 - tones 13
 - alerts 7
 - dog 4
 - location 5, 6
 - almanac 11
 - altimeter 14
 - calibrating 11
 - ANT+ sensors 17
 - pairing 17
 - area calculation 11
- B**
 - backlight 12, 15
 - bark detection 4
 - BaseCamp 5, 12, 16
 - battery 15
 - charging 2, 16
 - installing 1
 - life 13
 - maximizing 8, 12, 15, 16
 - replacing 17, 18
 - storage 15
 - beacon 8
 - bearing pointer 10
- C**
 - calendar 11
 - calibrating
 - altimeter 11
 - screen 13
 - charging 16
 - collar 2
 - handheld 2
 - cleaning the device 14
 - cleaning the touchscreen 14
 - collar 4
 - battery replacement 17
 - charging 2
 - contact points 6
 - fitting 4
 - light 8
 - replacing battery 17
 - replacing strap 18
 - VHF antenna 1, 18
 - compass 5, 10, 11
 - calibrating 10
 - navigating 10
 - settings 13
 - computer, connecting 16
 - contact 7, 8, 15, 16
 - adding 7
 - ID 8
 - settings 12
 - update rate 15
 - viewing on map 8
 - contact points 4, 6
 - course, pointer 11
 - covey, marking 8
- D**
 - data, sharing 10
 - data fields 12
 - deleting, all user data 16
 - device
 - care 14
 - registration 1
 - dog 4
 - adding 2, 3
 - alerts 4
 - collar 8
 - ID 3, 4
 - information 3, 4
 - navigating to 5
 - settings 12
 - statistics 3
 - track and train codes 3
 - tracking 5
 - tracks 3, 16
 - training 6, 7
 - training basics 6, 7
 - training intensity levels 6
 - type 3
 - update rate 15
- E**
 - elevation 10, 11
 - plot 11
- F**
 - files, transferring 16
 - fuse, changing 18
- G**
 - Garmin Express 14
 - registering the device 14
 - updating software 14
 - geofences 5, 6
 - GPS 12
 - settings 12
- H**
 - hunter 7
 - hunting and fishing times 11
- I**
 - icons 5
 - intensity level, choosing 6
- K**
 - keys 1
 - training 6, 7
- L**
 - line-of-sight radio communication 4
 - locking, screen 2
- M**
 - main menu, customizing 12
 - maps 8, 10
 - data fields 12
 - measuring distances 10
 - navigation 10
 - optional 17
 - orientation 10, 13
 - settings 13–15
 - updating 14
 - zoom 5, 13
 - marine, alarms setup 14
 - measuring distances 10
 - memory card 1, 16
 - messages 8
 - microSD card. *See* memory card
 - MicroSD card. *See* memory card
- N**
 - navigation 5, 10, 11
 - altimeter 11
- O**
 - on-screen buttons 2
- P**
 - pairing, ANT+ sensors 17
 - pausing dog tracking 5
 - power cables, changing the fuse 18
 - power key 1, 2
 - product registration 1, 14
 - proximity alarms 11
- R**
 - radio communication 4
 - radio frequencies 3
 - registering the device 1, 14
 - replacement parts 17, 18
- S**
 - satellite signals 12
 - acquiring 2
 - screen
 - locking 2
 - settings 12
 - settings 12–14
 - sharing data 10
 - Sight 'N Go 11
 - software
 - updates 14
 - updating 14
 - specifications 14, 15
 - stopwatch 12
 - sunrise and sunset times 11
- T**
 - tempe 17
 - temperature 17
 - time settings 13
 - tones 13
 - TracBack 10
 - tracks 3, 9, 10
 - navigating 10
 - recording 9
 - settings 12, 13
 - training
 - stimulation 6
 - tone 6
 - vibration 6
 - transferring
 - files 16
 - tracks 16
 - trip information
 - resetting 11
 - viewing 11
 - trip planner. *See* routes
 - troubleshooting 1
- U**
 - unit ID 14
 - units of measure 13
 - updates, software 14
 - USB
 - connector 1
 - disconnecting 17
 - mass storage mode 16
 - transferring files 16
 - user data, deleting 16
- V**
 - VHF antenna 1, 18
 - VIRB remote 12
 - VIRB remote 12
- W**
 - WAAS 12
 - waypoints 8, 11
 - deleting 9
 - editing 8, 9
 - projecting 9
 - saving 8
- Z**
 - zooming, maps 5

