

T500

800M Rechargeable Remote Spray Dog Trainer

-User Manual

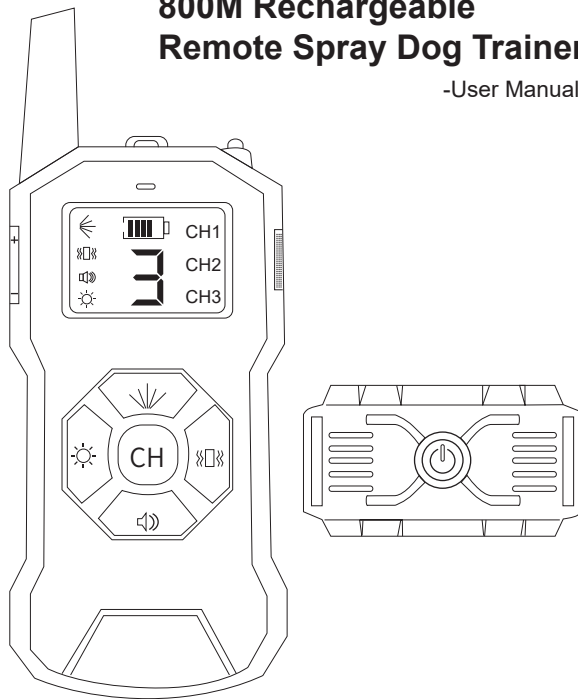

Please read this entire User Manual before beginning

Table of contents

— Precautions

Precautions	1
Precautions	2

— product Description

Main Features	3
Relevant description	4
Transmitter description	4
Receiver description	5

— How to Use it

Charging operation instruction	6
Charging requirements	6
Receiver charging state	6
Charging state of transmitter	7

— Operating Instructions for Various Functions of the Product

Power on-off	7
The receiver is paired with the transmitter	7
Channel switching operation mode	8
Spray function grade adjustment operation	8
Vibration function level adjustment operation	9
Tone function level adjustment operation	9
Light flicker function level adjustment operation	10
Flashlight operation	10
Friendly Tips	11

— How the System Works	12
— Warm Tips	12
— Summary of Frequently Asked Questions	13-15
— FCC Compliance	15
— Declaration of conformity	16
— Reference Size for Different Dogs	17-18

Components



Remote Transmitter



Collar Receiver



Wrist Strap



USB Charging Cable



User Manual



Screwdriver



Spray Refill (alternative)

Thank you for choosing our product. You can sync the remote transmitter and collar receiver to operate spray/vibration function to discourage your dog from unwanted behaviors and effectively train your dog at a long distance.

IMPORTANT SAFETY INFORMATION

Explanation of Attention Words and Symbols used in this User Manual



This is the safety alert symbol. It is used to alert you to potential personal injury hazards. Obey all safety messages that follow this symbol to avoid possible injury or death.



WARNING indicates a hazardous situation which, if not avoided, could result in death or serious injury.



CAUTION, used with the safety alert symbol, indicates a hazardous situation which, if not avoided, could result in minor or moderate injury.



CAUTION, used without the safety alert symbol, indicates a hazardous situation which, if not avoided, could result in harm to your pet.



Not for use with aggressive dogs. Do not use this product if your dog is aggressive, or if your dog is prone to aggressive behavior. Aggressive dogs can cause severe injury and even death to their owner and others. If you are unsure whether this product is appropriate for your dog, please consult your veterinarian or certified trainer.

Do not puncture or incinerate the collar or the refill cannister. Do not expose to extreme heat or store at temperatures above 113 °F or 45 °C.

Lithium Rechargeable Batteries. This device contains Lithium-Polymer (Li-Polymer) batteries; never incinerate, puncture, deform, short-circuit, or charge with an inappropriate charger. Fire, explosion, property damage, or bodily harm may occur if this warning is not followed.

Do not expose the device to freezing temperatures (32 °F or 0 °C) or to conditions warmer than 113 °F or 45 °C. Do not leave the collar in direct sunlight. Never leave the collar in a car where the device can heat up to high temperatures (113 °F or 45 °C).

- Contains gas under pressure; may explode if heated.
- Wear protective gloves / eye protection / face protection.
- Do not breathe dust / fume / gas/mist / vapors / spray.
- In case of inadequate ventilation, wear respiratory protection.
- If exposed or concerned: Get medical advice / attention.
- Protect from sunlight. Store in a well-ventilated place. Do not puncture. Do not burn.
- Keep out of reach of children.

FIRST AID TREATMENT:

If inhaled, get medical attention if you feel unwell. After skin contact, rinse affected area with soap and water. After eye contact, rinse/flush eyes gently using water for 15-20 minutes.



CAUTION

This product is not a toy. Keep it away from the reach of children.

CAUTION

Risk of skin damage. Please read and follow the instructions in this manual. Proper fit of the collar is important. A collar worn for too long or made too tight on the pet's neck may cause skin damage. Ranging from redness to pressure ulcers; this condition is commonly known as bed sores.

- Avoid leaving the collar on the dog for more than 12 hours per day.
- When possible, reposition the collar on the pet's neck every 1 to 2 hours.
- Check the fit to prevent excessive pressure; follow the instructions in this manual.
- Never connect a leash to the electronic collar.
- When using a separate collar for a leash, don't put pressure on the electronic collar.
- Wash the dog's neck area and the contact area of the collar weekly with a damp cloth.
- Examine the contact area daily for signs of a rash or a sore.
- If a rash or sore is found, discontinue use of the collar until the skin has healed.
- If the condition persists beyond 48 hours, see your veterinarian.

These steps will help keep your pet safe and comfortable. Millions of pets are comfortable while they wear smooth contacts. Some pets are sensitive to contact pressure. You may find after some time that your pet is very tolerant of the collar. If so, you may relax some of these precautions. It is important to continue daily checks of the contact area. If redness or sores are found, discontinue use until the skin has fully healed.

This Remote Spray Trainer must be used only on healthy dogs. We recommend that you take your dog to a veterinarian before using the collar if he is not in good health.

2. Main Features



4 IN 1 Training Modes:
Spray Stimulation +
Vibration + Tone + LED
light for Dog Searching



IPX5 Rainproof
Collar Receiver



Expandable to a
Three-Dog System



Backlit LCD Display



Innovative Painless
Stimulation Function,
More Scientific and
Humane



More Powerful Spray,
More Effective



Range Up to 800 Meters



Shock-Free, Safe and
Harmless



Built-in Rechargeable
Batteries, More
Environmental Friendly



Innovative Touch
Switch to Avoid
Misoperation

3. Relevant Description

1 Transmitter description

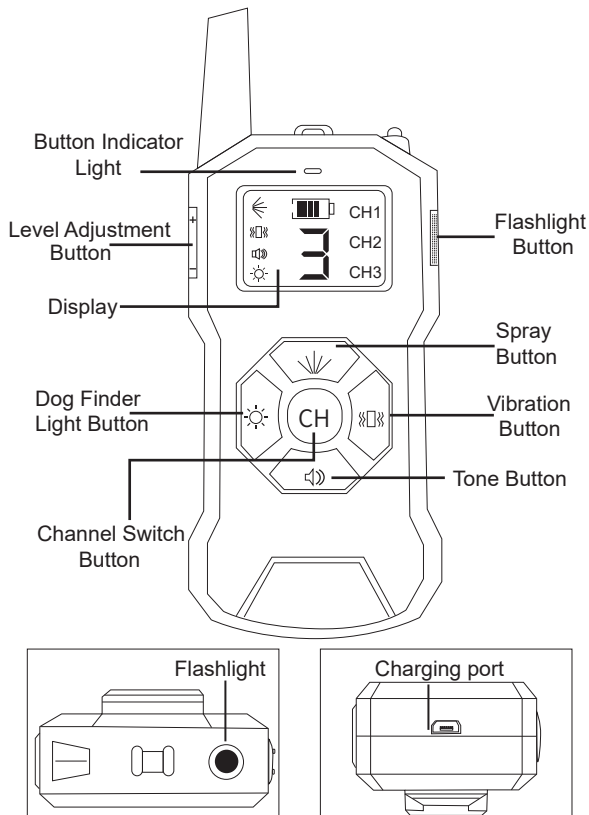

2 Receiver description

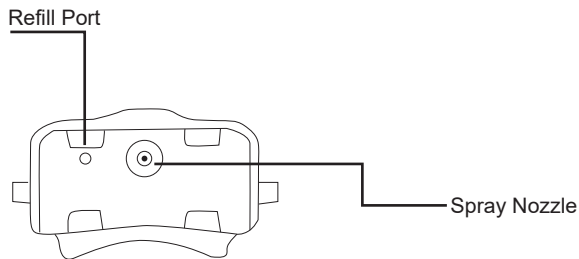
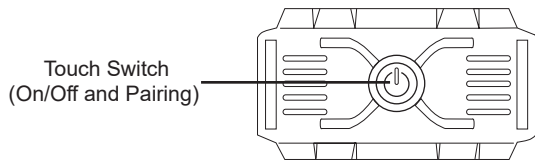
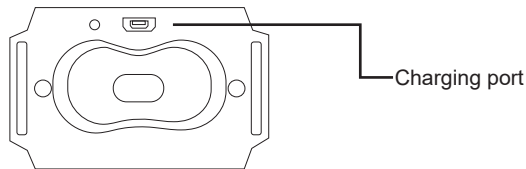

4. How to Use It

(note: please ensure the product fully charged before initial use!)

1 Charging operation instruction:

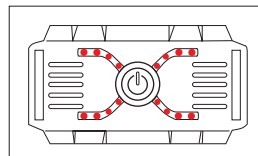

Receiver low voltage hint: when in low voltage state, The red light flashes five times every ten seconds

Transmitter low voltage hint: when its voltage is low, the indicator light flashes five times every 10 seconds, meanwhile, the battery in the screen displays 1 grid at the same time.

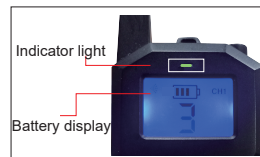

2 Charging requirements:

- The data cable is Micro USB
- Output voltage :DC5V
- Charge the battery completely before the first use (this may take up to 2 hours).
- Do not charge the battery near flammable substances.



3 Receiver charging state:

The red light will slowly brighten when charging, and the blue light will flash when fully charged.

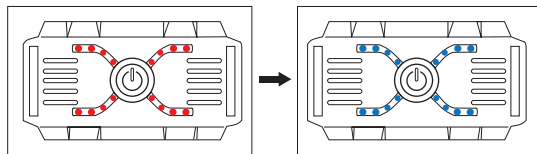

4 Charging state of transmitter:

When charging, the red indicator will flash; Meanwhile, the battery in screen is running. After full charge, the green indicator light will flash once in 10 seconds. The battery in screen is full of 4 cells at the same time.

5. Operating Instructions for Various Functions of the Product

1 Power on-off:

Power on: ● Long press the power button for 3 seconds.

- After starting up, the blue light will be on for 3 seconds, and the product will vibrate for 1 second at the same time.

Power off: Long press the power button for 3 seconds, and the red light flashes for 3 times after power off, and the product vibrates for 1 second at the same time

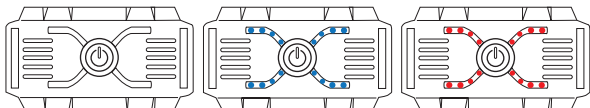

2 The receiver is paired with the transmitter:

Press the power button 3 times in a row, and the red light flashes, the pairing time will be within 20 seconds. Then press CH button of the transmitter to select the channel and press any of the function buttons to complete the pairing. After the pairing is successful, the blue light will stay on for 5s and the buzzer will emit two beeps at the same time.

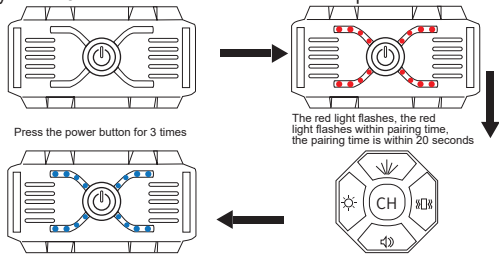

The blue light will stay on 5s after the successful pairing, and the buzzer emits two beeps at the same time

1. Press the CH button of the transmitter to select the channel

2. Press any function button to complete the pairing

3 Channel switching operation mode: press CH button to switch channels

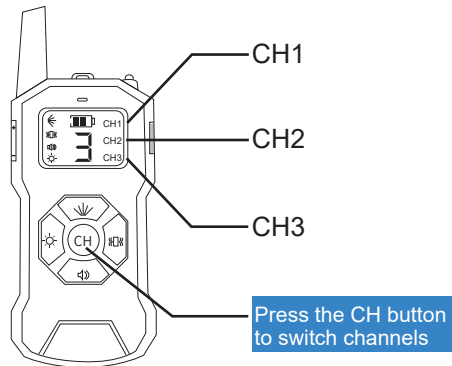

4 Spray function level adjustment operation

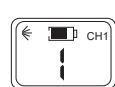

Mode 1-Weak



Model 2 - Strong



Mode 3- Pulse



5 Vibration function level adjustment operation:

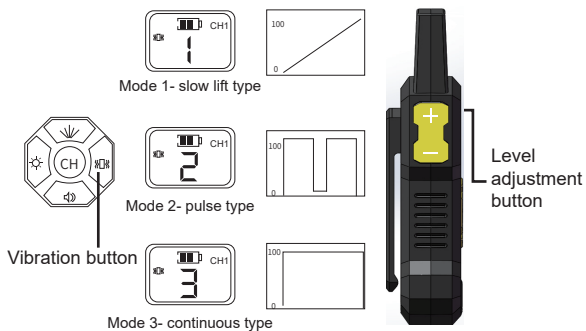

6 Tone function level adjustment operation:

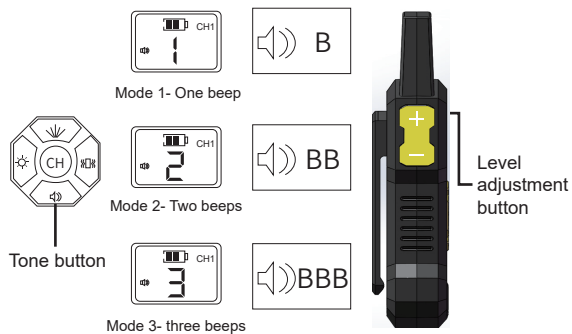

7 Light flicker function level adjustment operation:

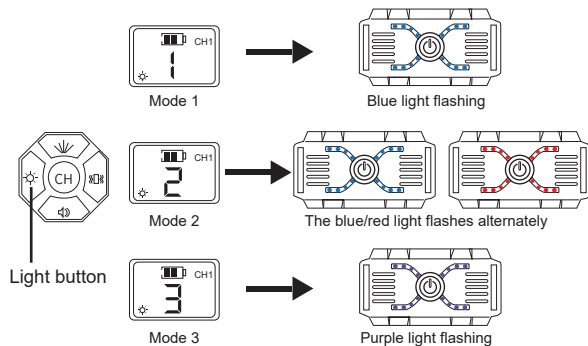

8 Flashlight operation:

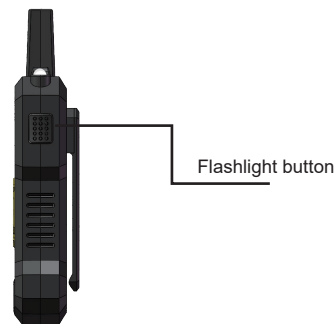

9 Friendly Tips:

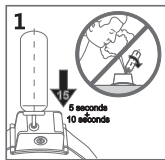

1. How to fill the citronella spray?

Turn off the collar first, set the collar on a flat surface with the refill port turned upwards. Hold the refill spray can upright and Vigorously and Firmly (important) press the nozzle down into the refill port until you feel a sinking. Hold down Vigorously and Firmly for 15 seconds and then release.



2. Adjust the neckband according to the size of the dog's neck, cut the remaining part of the neckband, and burn the cut edge with a lighter to avoid the fray.



3. Put the receiver collar on the dog's neck and install it with the spray nozzle aligned vertically dog's nose. Make sure the collar is not too tight nor too loose - One finger should just fit between the collar belt and your dog's neck.



4. For dogs with long body hair, it is necessary to trim the hair on the spray path, Ensure that the mist can be sprayed to an effective range.

6. How the System Works

The Remote Spray Trainer can easily help improve the communication between you and your dog. At the push of a button the remote sends a signal to your dog's collar. With three training options - tone, vibration and spray stimulation - you can ensure you will have a well-trained dog in a short amount of time.

The trainer can be used for off-leash walks within a range of up to 880 yards. The remote includes and easy- to-read digital display, and the training collar is light weight, rechargeable and water-resistant.

Using the remote spray dog trainer consistently and correctly, any basic obedience commands can be taught and many misbehaviors that your pet exhibits can be corrected.

Important: The remote spray trainer has a range up to 880 yards. Hold the Remote Transmitter in a horizontal position away from your body to achieve optimum range. Terrain, weather, vegetation, transmission from other radio devices, and other factors will affect the maximum range.

7. Warm Tips

Please read and follow the instructions in this manual. It is important to wear the collar correctly. When a pet wearing a collar for too long or too tight can cause skin damage. Too long or too tight wearing may cause stress, which can lead to skin damage. This is often mistaken for a burn.

1. Do not tie the device too tightly around the dog's neck.
2. Do not tie your belt to the collar.
3. Do not leave the device on the dog for more than 12 hours.
4. Replace the collar on your pet's neck every 1 or 2 hours.
5. Only used for connection to T500 transmitter and receiver.

8.Summary of Frequently Asked Questions

Fault Event	Boot Failure	NO1
Fault State	Unable to power on	
Reason Analysis	Press the on/off button(Power) for less than 3 seconds	
Troubleshooting Method	Press and hold continuously for 3 seconds, or change your finger to press until the device is turned on	

Fault Event	Boot Failure	NO2
Fault State	Unable to power on	
Reason Analysis	Press the power button and the red light flashes	
Troubleshooting Method	The blue light is on when normal startup. If the red light is on, it means there is no power and it needs to be charged.	

Fault Event	Boot Failure	NO3
Fault State	Unable to power on	
Reason Analysis	Unable to power off	
Troubleshooting Method	Press and hold continuously for 3 seconds, or change your finger to press, until the shutdown. Once shutdown successful,the red light flash, then off.	

Unable to spray	NO4	Fault Event
Internal solenoid valve doesn't work (no clicking sound)		Fault State
1.The product is out of power or the voltage is too low 2.The gas accumulation pressure inside the tank is too high		Reason Analysis
Charging Remove accumulated air (refer to Figure 1)		Troubleshooting Method

Unable to spray	NO5	Fault Event
Solenoid valve in operation (click sound can be heard)		Fault State
1.No gas 2.Product direction is wrong (nozzle forward. Tilt upward) 3.There's a foreign body blocking the inside		Reason Analysis
1.Inflatable 2.Re-wear the collar 3.Give a dog a trim or trim the hair around the device, and check to see if the nozzle is clogged with foreign matter such as dog hair.		Troubleshooting Method

Fault Event	Gas Leakage	NO6
Fault State	Spray nozzle leakage (gas directly is sprayed from the nozzle during inflation)	
Reason Analysis	There's foreign body inside	
Troubleshooting Method	1.Filling a few times more to use gas to remove foreign bodies, or clean the nozzle with a fine needle 2.Give a dog a trim or trim the hair around the device, and check to see if the nozzle is clogged with foreign matter such as dog hair.	

Fault Event	No gas can be feeded in	NO7
Fault State	After gas is refilled, there is no gas in the tank of the device.	
Reason Analysis	1.The air pressure inside the tank is too high to add gas	
	2.air nozzle blocking	
	3.The gas in the refill bottle has been used up	
	4.The nozzle of the refill bottle is not sprayed (blocked)	
Reason Analysis	5.The leakage of the gas nozzle of the refill bottle is serious, the pressure is not enough to add	
	6.The refill nozzle type of the refill bottle is wrong	

Troubleshooting Method	1.Remove accumulated air
	2.Professional staff repair or return to factory to repair
	3.Get a new one
	4.Get a new one
	5.Get a new one
	6.Get the correct type of refill

Fault Event	Unable to charge
Fault State	The indicator light doesn't go on when charging
Reason Analysis	1.The data cable USB are not plugged in properly
	2.The data cable is damaged
	3.The charging port of the device is damaged
Troubleshooting Method	1.Reinsert the data cale
	2.Micro USBReplace the data cable, its model is Micro USB
	3.(Identify a correct direction of charging port, because it is easy to be damaged in incorrect direction by violent insertion)

9.FCC Compliance

This device complies with part 15 of the FCC Rules. Operation is subject to the following two conditions: (1) This device may not cause harmful interference, and (2) this device must accept any interference received, including interference that may cause undesired operation.

Note: This equipment has been tested and found to comply with the limits for a Class B digital device, pursuant to part 15 of the FCC Rules. These limits are designed to provide reasonable protection against harmful interference in a residential installation. This equipment generates uses and can radiate radio frequency energy and, if not installed and used in accordance with the instructions, may cause harmful interference to radio communications. However, there is no guarantee that interference will not occur in a particular installation. If this equipment does cause harmful interference to radio or television reception, which can be determined by turning the equipment off and on, the user is encouraged to try to correct the interference by one or more of the following measures:

- Reorient or relocate the receiving antenna.
- Increase the separation between the equipment and receiver.
- Connect the equipment into an outlet on a circuit different from that to which the receiver is connected.
- Consult the dealer or an experienced radio/TV technician for help.
- Caution: Any changes or modifications to this unit not expressly approved by the party responsible for compliance could void the user's authority to operate the equipment.

Declaration of Conformity:



Declaration of conformity (see chapter „Declaration of conformity“): Products designated with this symbol fulfill all applicable community provisions of the European Economic Area.



This symbol certifies that the device's electromagnetic interference is below the limit approved by the United States Federal Communications Commission.



Disposal:Disposing of packaging Dispose of the packaging according to type:

- Cardboard and carton to waste paper
- Foils in the recycling collection



Disposing of the device Applicable in the European Union and other European countries with systems for separate collection of recyclable materials.



Old devices must not be disposed of in household waste! If the Modular Remote Trainer can no longer be used, all consumers are required by law to hand over the old devices separate from household waste, for example, at a collection point of their local community/district. This ensures that the old appliances are properly recycled and that negative effects on the environment are avoided. That is why electrical devices are marked with the symbol shown here

Reference Weight for Dogs

Large Dog (Body height above 24 inch, Weight above 88 lbs)
 Medium Dog (Height 16-24 inch, Weight 24.2-66 lbs)
 Small Dog (Height 10-16 inch, Weight 8.8-22 lbs)
 Mini Dog (Height under 10 inch, Weight under 8.8 lbs)

Reference Size for Different Dogs

Size	Neck(In)	Chest Measurement (In)	Back Length (In)	Type
Mini	7.8-8.6	9.8-11.8	7.5	Chihuahua, Yorkshire Terrier
Small	7.8-9.5	11.4-14.2	9	Chihuahua, Yorkshire Terrier, Poodle, Pomeranian
Medium	9.0-11.0	13.7-16.5	11	Maltese Dog, Shih Tzu
Large	9.6-12.2	16.2-18.5	12.2	Miniature Schnauzer, Pekingese
Large	11.8-13.4	18.1-20.8	13.8	Schnauzer, English Cocker Spaniel
Large	13.0-14.5	20.5-23.2	15.7	Beagle
Huge	17.0-18.9	30.0-33.0	23.6	Husky
	18.5-20.5	34.6-38.2	25.6	Labrador, Retriener
	21.6-24.4	36.2-39.3	27.5	Golden Retriener, Old English Sheepdog

