

Remote Training Collar

operating and training guide

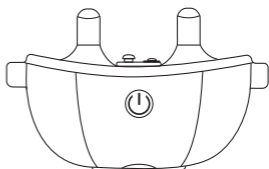

For 1 Dog

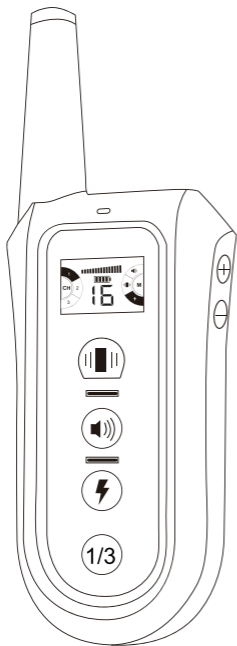
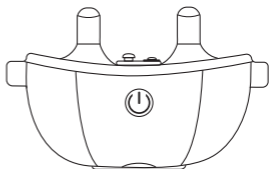

For 2 Dogs

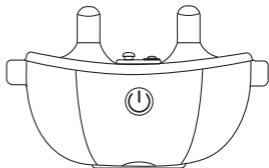

For 3 Dogs

PLEASE READ THIS ENTIRE GUIDE BEFORE BEGINNING

TABLE OF CONTENTS

PACKING COMPONENTS	1
SPECIFICATION	1
PRODUCT INTRODUCTION	2
OPERATION GUIDE.....	3
Charging	3
Transmitter	3
Receiver	5
Pairing Transmitter & Receiver.....	5
PRODUCT ASSEMBLY AND TESTING	6
Static Stimulation Column and Test	6
Receiver Collar Fitting	6
FREQUENTLY ASKED QUESTIONS	7
CAUTION	9
REFERENCE SIZE FOR DIFFERENT DOGS	10
DECLARATION OF CONFORMITY	10
PRODUCT MAINTENANCE/AFTER-SALES	12

PACKING COMPONENTS

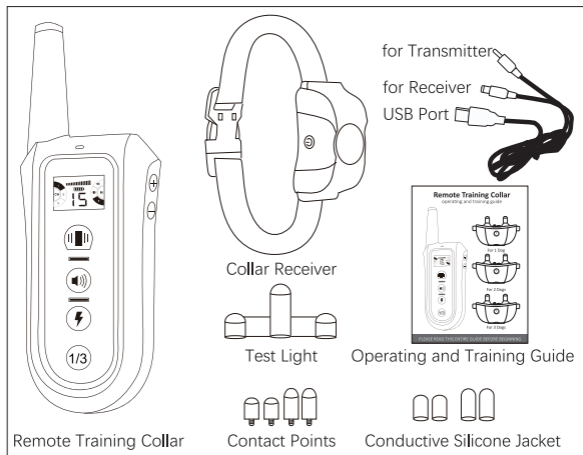

SPECIFICATION

Model: T220

Material: ABS + PC

Charging Method: DC + USB

Mode: Tone + Vibration + Static stimulation

Receiver Waterproof Grade: IPX7

Remote Range: Up to 450 yards (400M) in open area without interference

Transmitter Battery Capacity: 250 Mah

Receiver Battery Capacity: 500 Mah

PRODUCT INTRODUCTION

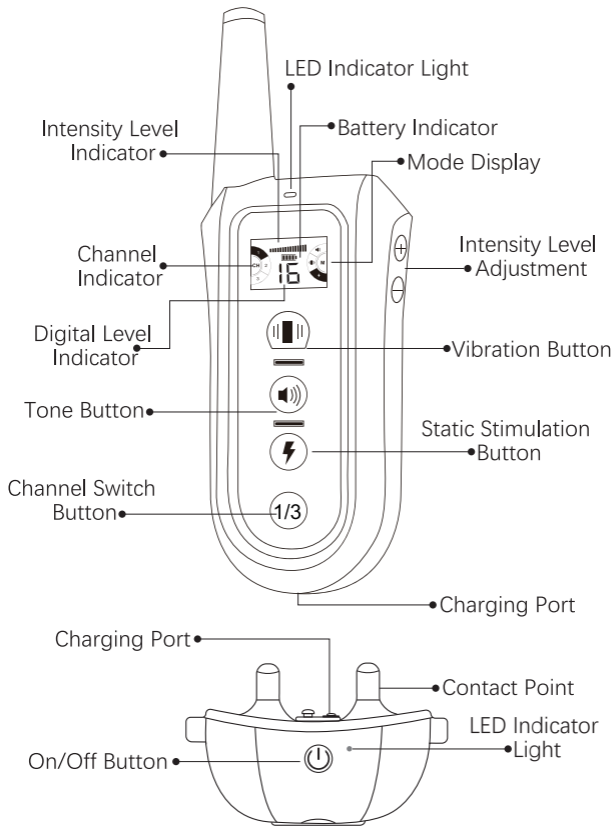

OPERATION GUIDE

1. Charging

(please ensure the product fully charged before use)



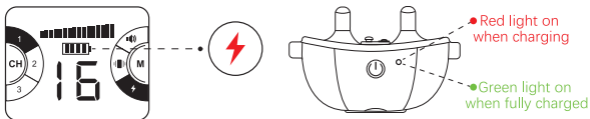

Connect the charger cable to the transmitter/receiver's charging ports and ensure good contact; It takes about 2 hours to fully be charged when connected to output of charger (Transmitter (on/off) battery bar scrolls when charging and stays still when fully charged. Receiver red light will be turned on when the charging cable is plugged in. The green light will always be on when it is fully charged).



2. Transmitter

① Power On

Press any button to turn on transmitter.

Backlight is on and icons are displayed     
(no on/off button on transmitter).

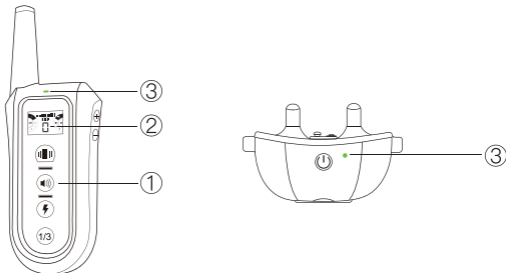

② Tone Button

Level 0. When pressed, 0 is displayed on transmitter, with green indicator lights flash on transmitter and receiver.

③ Vibration Button

Level 0-8. When pressed, level digit is displayed on transmitter, with green indicator lights flash on transmitter and receiver.

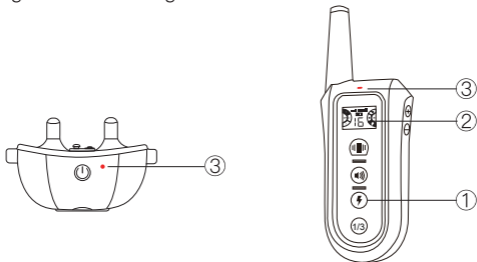

④ Static Stimulation Button

Level 0-16. When pressed, level digit is displayed on transmitter, with red indicator lights flash on transmitter and receiver.

⑤ Button

Switching to different channels and 3 channels simultaneously operated.

⑥ Button

Press the “+ -” adjustment button on the side of the transmitter. If pressed and held, the level will automatically go up “+” or down “-” (The longest working duration is 15s when tone / vibration button is pressed and held and 10s when static stimulation button is pressed and held)

(Note: It is not recommended to punish the dog by pressing the static stimulation button for a long time to avoid physical or psychological damage to the dog)

3.Receiver

Power on: Press once to turn it on, with one beep sound and green indicator light flashes.

Power off: Press once to turn it off, with two beep sounds and red indicator light flashes.



Power on



Power off

4.Pairing Transmitter & Receiver

❶ Turn on the remote control transmitter and press the "1/3" button to select a signal channel.

❷ Long press the receiver on/off button for 3 seconds and its red indicator light enters a fast flashing state, lasting for 10 seconds. In the meanwhile, press the function button of the remote control transmitter (vibration/static stimulation/tone) to pair transmitter and receiver successfully.

(If the function button is not pressed within 10 seconds of flashing state, code matching state will expire)

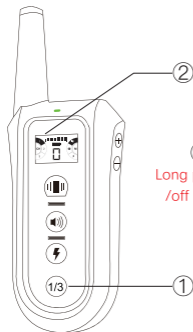

Long press on /off button

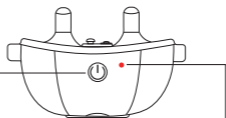

Red indicator light enters a fast flashing state, lasting for 10 seconds. In the meanwhile, press the function button of the remote control transmitter (vibration/static stimulation/tone) to pair transmitter and receiver successfully.

PRODUCT ASSEMBLY AND TESTING

1. Static Stimulation Column and Test

- ① Tighten the column screw into the screw hole of the receiver.
- ② Put on the conductive silicone cap.
- ③ Insert the test light on the silicone cap.
- ④ Press the static stimulation button of the transmitter.
- ⑤ The test light shows red as static stimulation function is on.

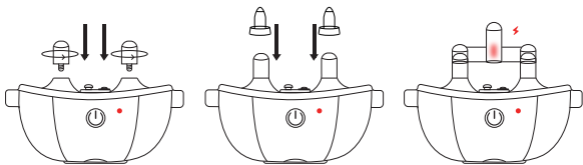

2. Receiver Collar Fitting

Fit the receiver collar correctly to ensure effective operation. Please follow the steps below to fit it:

A. Check if the receiver is turned off and keep the dog in a comfortable standing position.

B. Place the receiver in the middle of the dog's neck with the switch button facing upward. When properly fitted, you should be able to fit a finger snugly in between the collar and dog's neck. An overly loose or tight fit can compromise the product's normal function.

C. Mark the proper length on the collar, remove it, reduce the excess part and then use a lighter to burn the frayed edges of the collar.

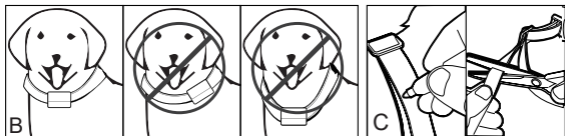
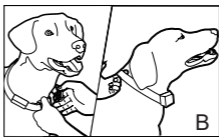
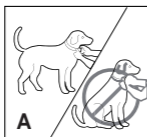

FREQUENTLY ASKED QUESTIONS

Q: Once my pet is trained and has been obeying my commands, will he/she have to continue to wear the receiver collar?

A: Probably not. You may need to reinforce training with the receiver collar from time to time.

Q: Is the receiver collar waterproof?

A: Yes. The waterproof grade is IPX7, but based on safety considerations, dogs wearing a collar for swimming may be stuck in the collar by "foreign objects", which may cause the neck to be strangled. Swimming while the collar fitted is not recommended.

Q: How long should I process my training session for my pet?

A: Training sessions should be kept positive and short, better for about 10-15 minutes each time.

Q: How long can I continuously deliver vibration to my pet?

A: The maximum amount of time you can press the vibration button and deliver vibration to your pet continuously is 15 seconds. After this, vibration cannot be delivered until you release and press the button again.

Q: Does the product have after-sales service?

A: Our products have after-sales service. As long as it is a quality problem and not caused by man-made damage or misoperation, it can be guaranteed within 1 year.

Q: Is the vibration function safe for my pet?

A: Although vibration is unpleasant, it is harmless to your pet. Electronic training equipment requires user interaction and training to achieve the desired effect.

Q: How old is enough for my pet to use the dog trainer?

A: Your pet should be able to recognize basic obedience commands, such as "sit down" or "stand up". Your pet must be at least 6 months old to use the dog trainer.

Tips:

Please read and follow the instructions in this manual. The correct wearing of the collar is important. Putting a collar on a pet's neck for too long or too tight can cause skin damage. This is usually mistaken for burns.

1. Do not tie the leash to the receiver dog leash.
2. Do not leave the receiver on the dog for more than 12 hours.

CAUTION



Warning:

- A. This product is suitable for large, medium and small dogs.
- B. This product cannot be tried directly on humans, otherwise it will violate local laws.
- C. Please turn off or take off the receiver before playing with the dog.
- D. Please do not put the receiver on the dog for a long time.



Warning:

- A. It is strictly forbidden to be played by children as toys.
- B. It is strictly forbidden to place the product near the stove or in a high temperature place.
- C. It is strictly forbidden to open the product shell, which will cause short circuit of lithium and cause a fire.
- D. The company will not be responsible for any direct or indirect losses caused by misuse.

REFERENCE SIZE FOR DIFFERENT DOGS

REFERENCE SIZE FOR DIFFERENT DOGS				
Size	Neck(In)	Chest Measurement (In)	Back Length (In)	Type
Mini	7.8-8.6	9.8-11.8	7.5	Chihuahua, Yorkshire Terrier
Small	7.8-9.5	11.4-14.2	9	Chihuahua, Yorkshire Terrier, Poodle, Pomeranian
Medium	9.0-11.0	13.7-16.5	11	Maltese Dog, Shih Tzu
Large	9.6-12.2	16.2-18.5	12.2	Miniature Schnauzer, Pekingese
Large	11.8-13.4	18.1-20.8	13.8	Schnauzer, English Cocker Spaniel
Large	13.0-14.5	20.5-23.2	15.7	Beagle
Huge	17.0-18.9	30.0-33.0	23.6	Husky

DECLARATION OF CONFORMITY

This device complies with part 15 of the FCC Rules. Operation is subject to the following two conditions:

- (1) This device may not cause harmful interference,
- (2) This device must accept any interference received, including interference that may cause undesired operation.

Note:

This equipment has been tested and found to comply with the limits for a Class B digital device, pursuant to part 15 of the FCC Rules.

These limits are designed to provide reasonable protection against harmful interference in a residential installation.

This equipment generates uses and can radiate radio frequency energy and, if not installed and used in accordance with the instructions, may cause harmful interference to radio communications. However, there is no guarantee that interference will not occur in a particular installation.

If this equipment does cause harmful interference to radio or television reception, which can be determined by turning the equipment off and on, the user is encouraged to try to correct the interference by one or more of the following measures:

- Reorient or relocate the receiving antenna.
- Increase the separation between the equipment and receiver.
- Connect the equipment into an outlet on a circuit different from that to which the receiver is connected.
- Consult the dealer or an experienced radio/TV technician for help.
- Caution: Any changes or modifications to this unit not expressly approved by the party responsible for compliance could void the user's authority to operate the equipment.

PRODUCT MAINTENANCE/AFTER-SALES

1.If you find that there is a problem within 30 days upon receiving the product, you need to take a video or picture of the faulty product. After the customer service confirms, you can return the product. Product with quality problem must be returned within 7 days. Replacement will be shipped upon receiving the returned product.

2.If the product is found to have quality problems during the one-year warranty period, the customer can return it with shipping fee paid by themselves. If the product has a problem, we will repair it for free.

3.This warranty is in addition to the other rights and remedies specified. According to the law, for major failures and any other compensation, if it is a reasonably foreseeable loss or damage, you have the right to replace or refund.

4.You also have the right to product repair or replacement under the following situation: the quality of the product is substandard and the failure does not constitute a major one. If you have any questions or need more information, please contact our customer service.



MADE IN CHINA