



Operating Guide
Manuel d'utilisation
Gebruiksaanwijzing
Manual de funcionamiento
Guida all'uso
Gebruiksaanweisung
Brugervejledning

PRF-3004XW-20

Stubborn Dog In-Ground Fence™ System

Système de clôture anti-fugue avec fil pour chien têtu

Omheiningssystem met draad voor koppige honden

Limitador de zona con cable para perros difíciles de adiestrar

Sistema antifuga con filo per cani ostinati

Rückhaltesysteme mit Draht für widerspenstige Hunde

Nedgravet hegnsystem til stædige hunde

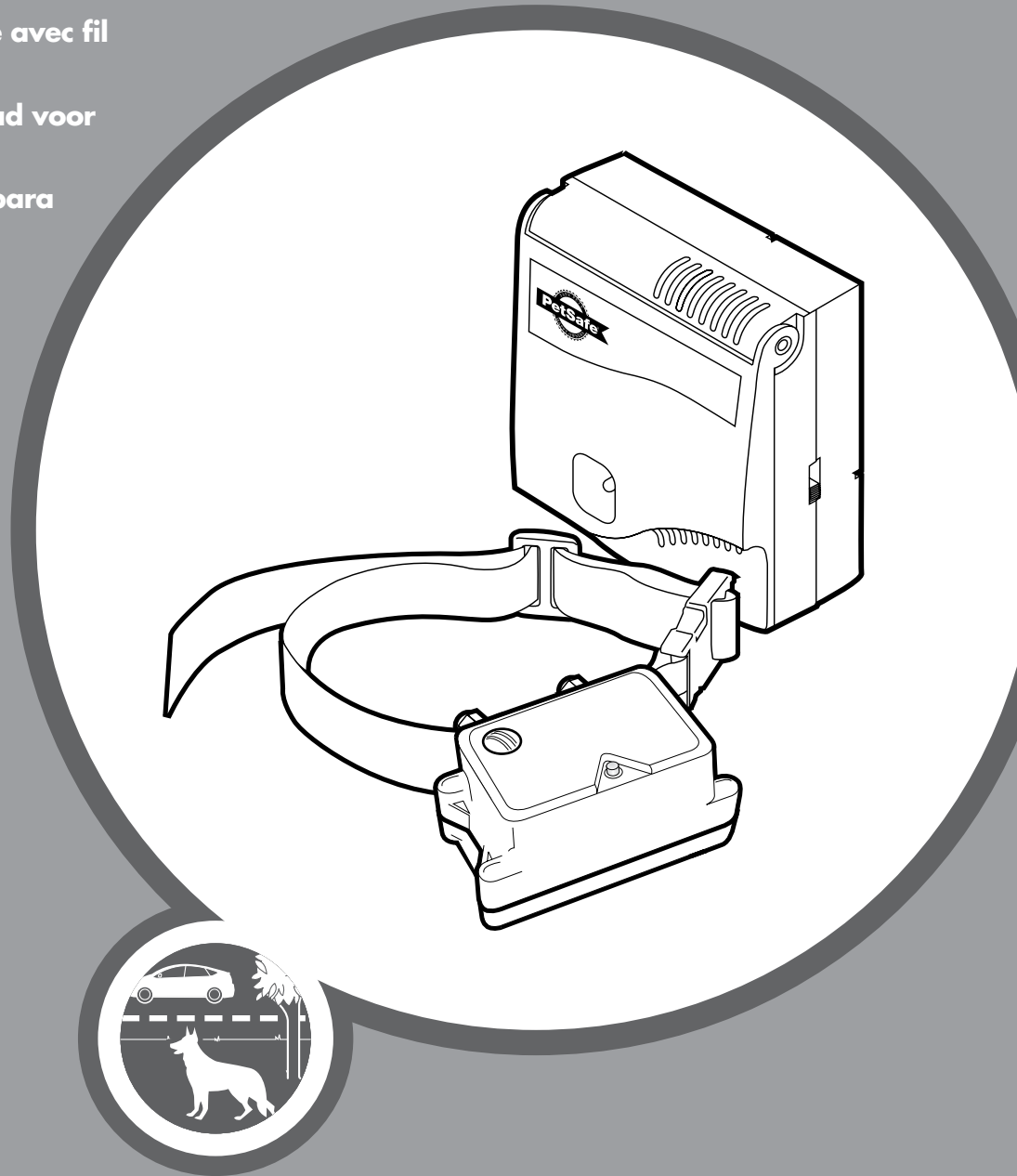

Please read this entire guide before beginning
Veuillez lire ce manuel en entier avant de commencer
Gelieve deze gids volledig door te lezen voordat u begint
Por favor, este manual lea completo antes de empazar
Si prega di leggere attentamente la guida all'uso prima di utilizzare il collare
Bitte lesen Sie die gesamte Betriebsanleitung vor dem Trainingsbeginn
Læs venligst hele vejledningen, inden produktet tages i brug

IMPORTANT SAFETY INFORMATION

Explanation of Attention Words and Symbols used in this guide



This is the safety alert symbol. It is used to alert you to potential personal injury hazards. Obey all safety messages that follow this symbol to avoid possible injury or death.

⚠ WARNING

WARNING indicates a hazardous situation which, if not avoided, could result in death or serious injury.

⚠ CAUTION

CAUTION, used with the safety alert symbol, indicates a hazardous situation which, if not avoided, could result in minor or moderate injury.

CAUTION

CAUTION, used without the safety alert symbol, indicates a hazardous situation which, if not avoided, could result in harm to your pet.

NOTICE

NOTICE is used to address practices not related to personal injury.

⚠ WARNING

- **Not for use with aggressive dogs.** Do not use this product if your dog is aggressive or if your dog is prone to aggressive behaviour. Aggressive dogs can cause severe injury. If you are not sure that this product is right for your dog, please talk to your veterinarian or a certified trainer.
- Underground cables can carry high voltage. Have all underground cables marked before you dig to bury your wire. In most areas, this is a free service.
- Do not install, connect, or remove your system during a lightning storm. If the storm is close enough for you to hear thunder, it is close enough to create hazardous surges.
- Follow all safety instructions for your power tools. Be sure to always wear your safety goggles.
- Risk of Electric Shock. Use the Fence Transmitter indoors in a dry location only.
- DO NOT attempt to cut into or pry open the battery. Be sure to discard the used battery properly.

⚠ CAUTION

- Risk of injury. Wire on top of the ground may be a trip hazard. Use care in how you place your wires.
- This system is NOT a solid barrier. The system is designed to act as a deterrent to remind pets by Static Correction to remain in the boundary established. It is important that you reinforce training with your pet on a regular basis. Since the tolerance level to Static Correction varies from pet to pet, Radio Systems® Corporation CANNOT guarantee that the system will, in all cases, keep a pet within the established boundary. Not all pets can be trained to avoid crossing the boundary! Therefore, if you have reason to believe that your pet may pose a danger to others or harm himself if he is not kept from crossing the boundaries, you should NOT rely solely upon the system to confine your pet. Radio Systems® Corporation shall NOT be liable for any property damage, economic loss or any consequential damages, sustained as a result of any animal crossing the boundary.

CAUTION

- Please read and follow the instructions in this manual. Proper fit of the collar is important. A collar worn for too long or made too tight on the pet's neck may cause skin damage. This is called bed sores; it is also called decubitus ulcers or pressure necrosis.
- Avoid leaving the collar on the dog for more than 12 hours per day.
- When possible reposition the collar on the pet's neck every 1 to 2 hours.
- Check the fit to prevent excessive pressure; follow the instructions in this manual.
- Never connect a lead to the electronic collar; it will cause excessive pressure on the contacts.
- When using a separate collar for a lead, don't put pressure on the electronic collar.
- Wash the dog's neck area and the contacts of the collar weekly with a damp cloth.
- Examine the contact area daily for signs of a rash or a sore.
- If a rash or sore is found, discontinue use of the collar until the skin has healed.
- If the condition persists beyond 48 hours, see your veterinarian.

For additional information on bed sores and pressure necrosis, please visit our website.

These steps will help keep your pet safe and comfortable. Millions of pets are comfortable while they wear stainless steel contacts. Some pets are sensitive to contact pressure. You may find after some time that your pet is very tolerant of the collar. If so, you may relax some of these precautions. It is important to continue daily checks of the contact area. If redness or sores are found, discontinue use until the skin has fully healed.

- You may need to trim the hair in the area of the Contact Probes. Never shave the dog's neck; this may lead to a rash or infection.
- You should not make the collar any tighter than is required for good contact. A collar that is too tight will increase the risk of pressure necrosis in the contact area.
- Proper training of your pet is essential to the success of the PetSafe® Stubborn Dog In-Ground Fence™. During the first 2 weeks of training, do not use the training device on your pet without direct supervision.
- To prevent an unintended correction:
 - The receiver collar should not be on your dog when the system is tested.
 - Remove the receiver collar before making any changes to your system.
 - Before placing the receiver collar on your pet, test the boundary location and width after any change.
- If possible, do not use an outlet protected with a residual current device (RCD) or ground fault circuit interrupter (GFCI). The fence system will function properly, but in rare cases, nearby lightning strikes may cause the RCD or GFCI to trip. Without power, your pet may be vulnerable to escape. You will have to reset the RCD or GFCI to restore power to the system.

NOTICE

- Avoid damage to the insulation of the loop wire during the install; damage may cause areas of weak signal and lead to early failure of the loop (wire breaks).
- Use care when mowing or trimming your grass not to cut the loop wire.
- For added protection for the Fence Transmitter when unused for long periods of time or prior to thunderstorms, disconnect the Loop Boundary Wires and unplug the Power Adapter from the outlet. This will prevent damage to the Transmitter due to surges.

Thank you for choosing PetSafe®. Through consistent use of our products, you can have a better behaved dog in less time than with other training tools. **If you have any questions, please contact the Customer Care Centre. For a listing of Customer Care Centre telephone numbers, visit our website at www.petsafe.net.**

To get the most protection out of your warranty, please register your product within 30 days at www.petsafe.net. By registering, and keeping your receipt, you will enjoy the product's full warranty and should you ever need to call the Customer Care Centre we will be able to help you faster. Most importantly, PetSafe® will never give or sell your valuable information to anyone. Complete warranty information is available online at www.petsafe.net.

Table of Contents

Components	5
Other Items You May Need.....	5
How the System Works	6
Key Definitions	6
Operating Guide	
Install the Fence Transmitter.....	7
Lay Out the System	7
Sample Layouts.....	8
Position the Boundary Wire	9
Connect the Wires to the Fence Transmitter	10
Prepare the Receiver Collar.....	11
Set the Boundary Width and Test the Receiver Collar.....	12
Install the Boundary Wire	13
Place the Boundary Flags	14
Fit the Receiver Collar.....	15
Training Guide	
Be Patient With Your Pet	16
Day 1 - Boundary Flag Awareness.....	17
Days 2 thru 4 - Continue Boundary Flag Awareness	17
Days 5 thru 8 - Distraction Phase	18
Days 9 thru 14 - Off-Lead Supervision.....	18
Days 15 thru 30 - Pet Monitoring	19
Days 31+ Tone Plus Vibration Only Training	19
Taking Your Pet Out of the Pet Area	19
Accessories	20
Add-A-Dog® Additional Receiver Collars Instructions for Use.....	20
Frequently Asked Questions	22
Troubleshooting.....	23
Short Loop Test	24
To Locate a Break in the Boundary Wire	24
Terms of Use and Limitation of Liability	25
Compliance	25
Battery Disposal.....	25

Components

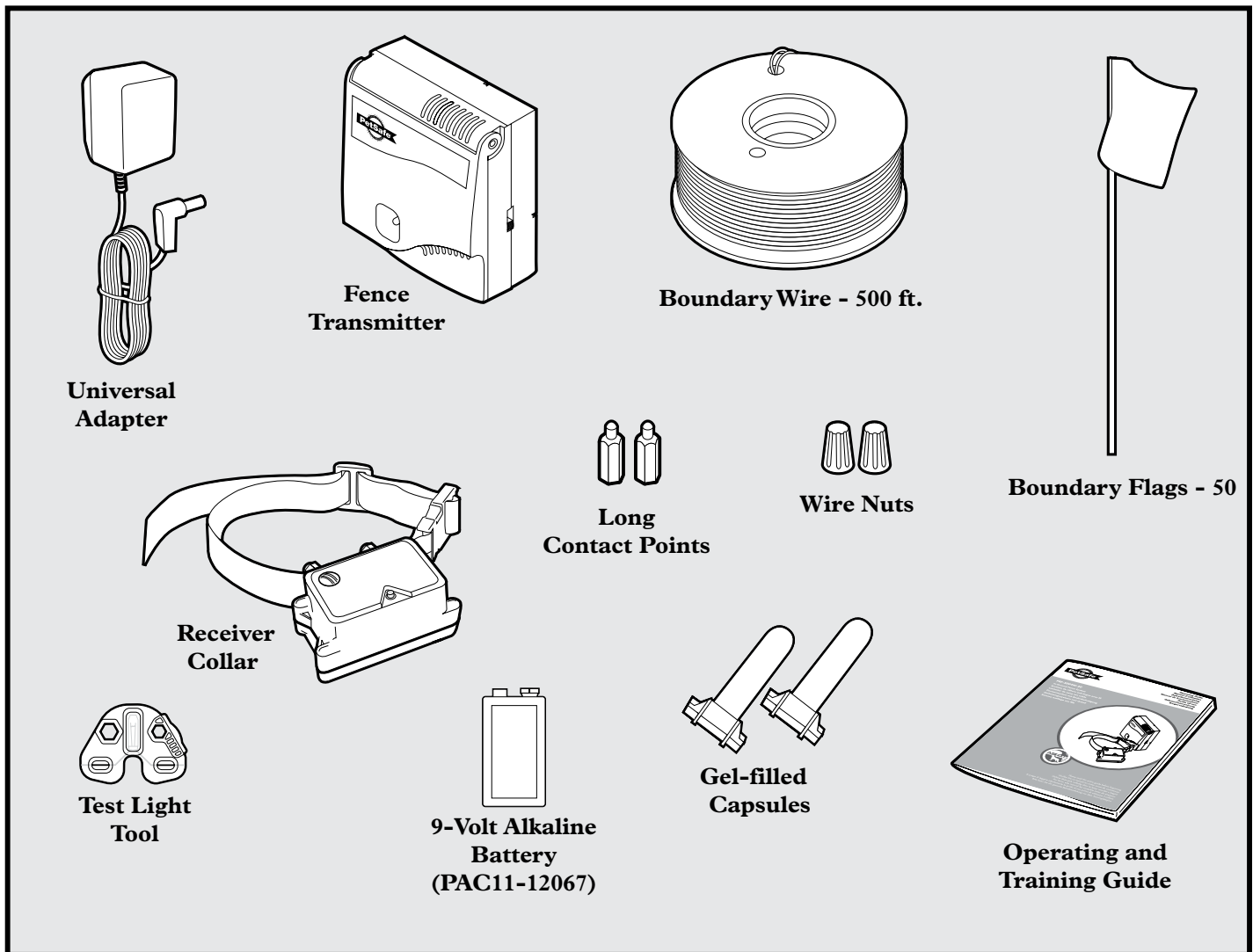

Other Items You May Need

- Additional wire and flags (Part #PRFA-500)
- Tape measure
- Small Phillips screwdriver
- Drill & mounting hardware
- Shovel or lawn edger
- Pliers
- Wire stripping pliers
- Scissors
- Lighter
- Gel-filled Capsules
- Additional wire nuts
- Waterproofing compound (either silicone sealant or decorator's caulk, but silicone sealant is better)
- PVC pipe or hose pipe
- Circular saw with masonry blade
- Staple gun
- Non-metallic collar and lead

Fence installation and training help, interactive fence planning software: www.petsafe.net/fence

How the System Works

A radio signal travels through a buried wire, marking the boundaries you wish to set for your dog. Your dog wears a Receiver Collar that detects the signal at the boundary. As your dog approaches the boundary, the receiver issues a warning tone with vibration. If he proceeds further, he receives a safe but startling Static Correction. While harmless, the Correction will persuade him to stay in the Containment Area you've established. The Stubborn Dog Receiver Collar offers 5 levels of correction, adjustable to your dog's temperament. This PetSafe® Stubborn Dog In-Ground Fence has been proven safe, comfortable, and effective for pets over 3.6 kg (8 lbs).

Key Definitions

Fence Transmitter: Transmits the radio signal through the Boundary Wire.

Pet Area: Area within the Warning Zone where your pet can roam freely.

Warning Zone: Outer edge of the Pet Area where your pet's Receiver Collar begins to beep, warning him not to go into the Static Correction Zone.

Static Correction Zone: Zone beyond the Warning Zone where your pet's Receiver Collar will emit a Static Correction, signaling him to return to the Pet Area.

Boundary Width: Combination of the Warning Zone and the Static Correction Zone.

Receiver Collar: Receives the radio signal from the Boundary Wire.

Correction Level Button: Adjusts the level of Static Correction your pet receives in the Static Correction Zone.

Receiver Indicator Light: Indicates the level of correction at which the Receiver Collar is set. This light also serves as a low battery indicator.

Contact Points: Delivers the safe Static Correction when your pet moves into the Static Correction Zone.

Power Jack: Where the Power Adapter plugs into the Fence Transmitter. The Fence Transmitter is powered by a standard outlet.

Boundary Control Switch: Switch located on the Fence Transmitter to adjust according to the length of Boundary Wire used.

Boundary Wire Terminals: Where the Boundary Wires connect to the Fence Transmitter in order to complete a continuous loop.

Loop Indicator Light: Indicates that the Boundary Wire makes a complete loop, enabling the signal to be transmitted.

Boundary Width Control: Adjusts the width of the Warning and Static Correction Zones. *Note: Adjusting the knob does not change the level of Static Correction on the Receiver Collar.*

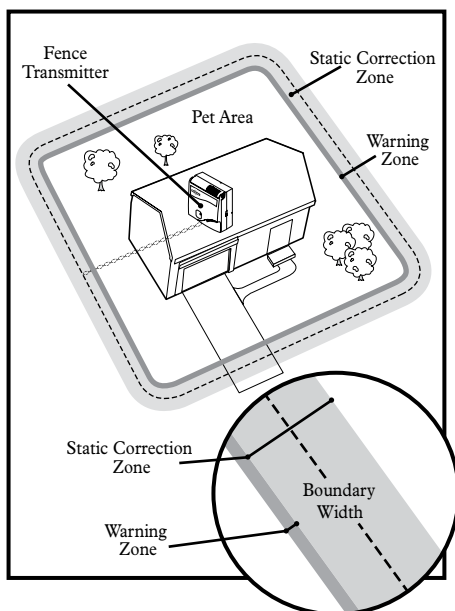

Receiver Collar

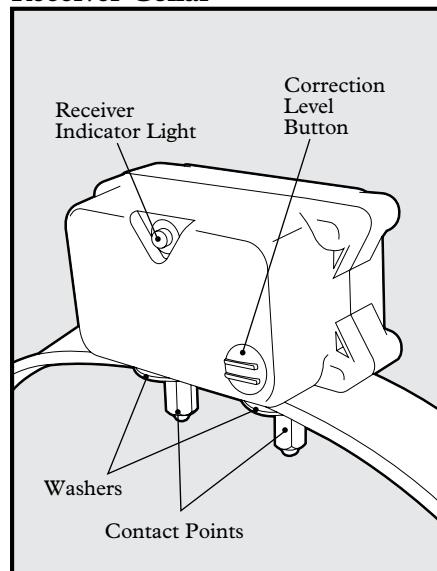

Fence Transmitter

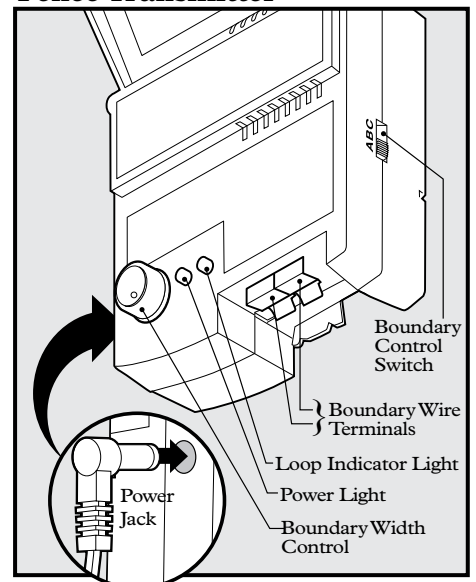

Operating Guide

Step 1 Install the Fence Transmitter

1

Place the Fence Transmitter:

- In a dry, well ventilated, protected area (1A, 1B).
- In an area where temperatures do not fall below freezing (e.g., garage, basement, shed).
- Secured to a stationary surface using appropriate mounting hardware (not included). A mounting template is included in the back of this guide.
- At least 1 m (3 ft) from large metal objects or appliances as these items may interfere with the signal consistency (1C).

Once you have mounted the Fence Transmitter, the Boundary Wire must exit the building. This can be accomplished via a window or through a hole drilled through the wall. Ensure the drill path is clear of any utilities.

Make sure the Boundary Wire is not cut off or pinched by a window, door, or garage door, as this can damage it over time and create a wire break. To prevent fires and electrical hazards, install the Fence Transmitter in buildings that are in accordance with state and local electrical codes.

⚠WARNING Risk of Electric Shock. Use the Fence Transmitter indoors in a dry location only.

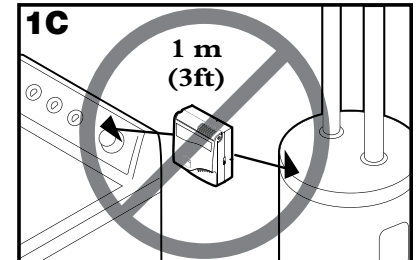
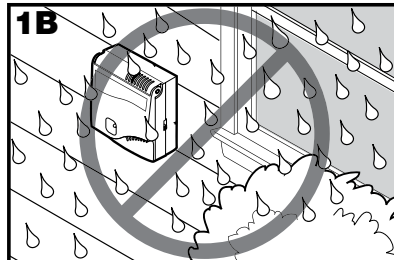
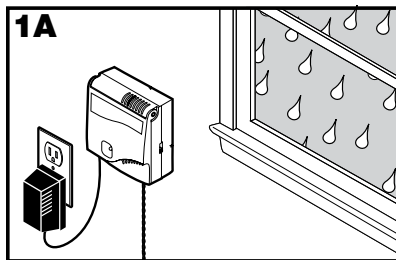

Step 2 Lay Out the System

2

⚠WARNING Underground cables can carry high voltage. Have all underground cables marked before you dig to bury your wire. In most areas, this is a free service.

For information regarding how these underground wires can affect your system's operation, see Step 3 "Position the Boundary Wire".

Basic Planning Tips

- The Boundary Wire **MUST** start at the Fence Transmitter and make a continuous loop back (2A).
- Design a layout that is suitable for your property. Sample layouts are provided in this section, and a grid for designing your layout is provided in the back of this guide.
- Fence planning software is available online at www.petsafe.net/fence. After you have planned and saved your layout online, contact our Customer Care Centre to review and refine your layout.
- Twisting two sides of the Boundary Wire cancels the signal and allows your pet to cross over that area safely. Plastic or metal piping will not cancel the signal. Twist the Boundary Wire 30 times per metre (10 times per foot) to cancel the signal (2A).

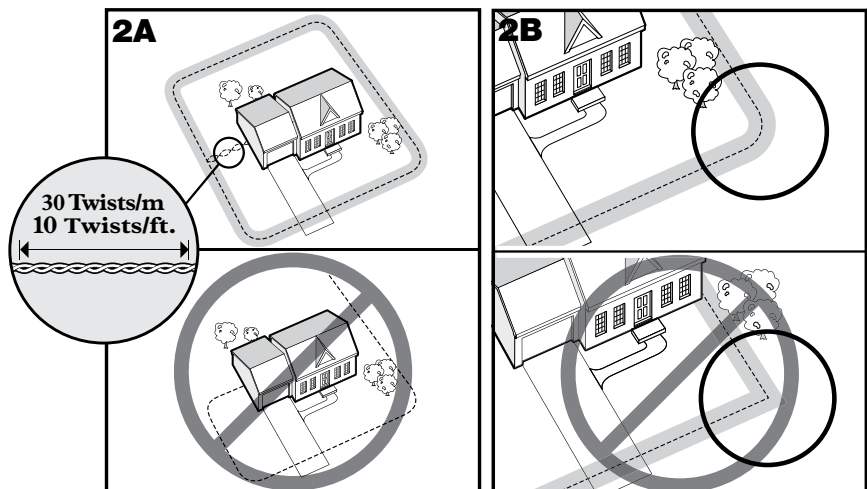

- Always use gradual turns at the corners with a minimum 1 m (3 ft) radius, to produce a more consistent boundary (2B). Do not use sharp turns, as this will cause gaps in your boundary.
- Avoid making passageways too narrow for your pet to move about freely (e.g., along the sides of a house).
- The Receiver Collar can be activated inside the house if the Boundary Wire runs along the outside wall of the house. If this occurs, remove your pet's Receiver Collar before bringing him inside, decrease the range using the Boundary Width Control knob or consider an alternative layout.

Sample Layouts

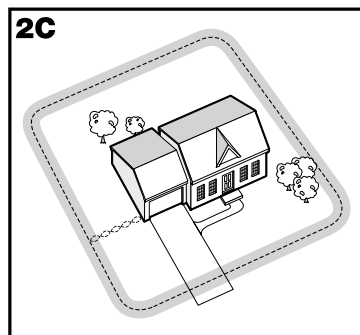

Sample 1: Perimeter Loop (Single Loop) The Perimeter Loop is the most common layout. This will allow your pet to freely and safely roam your entire property (2C). It can also protect flower gardens and landscaping (2D).

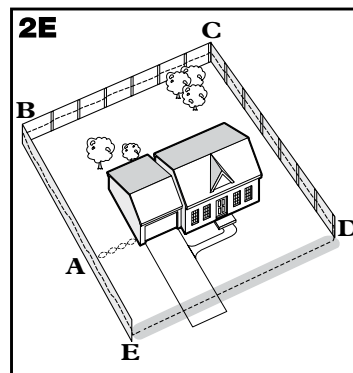
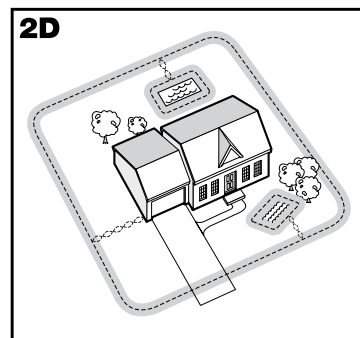

Sample 2 (2E): Perimeter Loop Using Existing Fence (Single Loop)

This layout allows you to include your existing fence as part of your layout and keep your pet from jumping out or digging under your existing fence. It reduces the amount of wire which will need to be buried. From the Fence Transmitter, run the wire to A, A to B, B to C, C to D, D to E, E to A, twist the wires from A back to the Fence Transmitter. See the "Install the Boundary Wire" section for more information on attaching the wire to a fence.

Double Loop

A Double Loop must be used when you are not establishing the Boundary Zone on all sides of your property. When using a Double Loop, the Boundary Wire must be separated by a minimum of 1.5 m (5 ft) to avoid canceling the signal. Remember that a Double Loop will require twice as much wire.

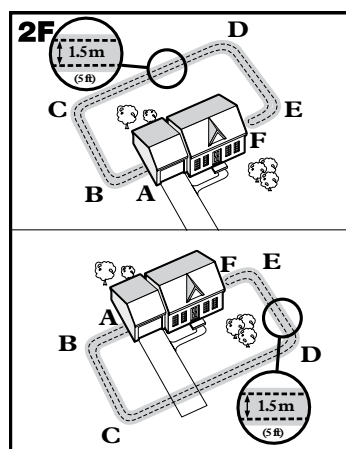

Sample 3 (2F): Front or Back Property Only (Double Loop)

From the Fence Transmitter, run the wire to A, A to B, B to C, C to D, D to E, E to F, make a U-turn and follow your path all the way back to A, keeping the wire separated 1.5 m (5 ft). Twist the wire from A back to the Fence Transmitter.

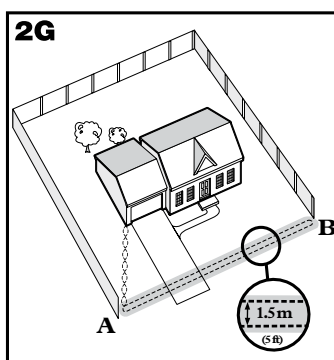

Sample 4 (2G): Front Boundary Only (Double Loop)

From the Fence Transmitter, run the wire to A, A to B, B back to A keeping the wire separated 1.5 m (5 ft). Twist the wire from A back to the Fence Transmitter.

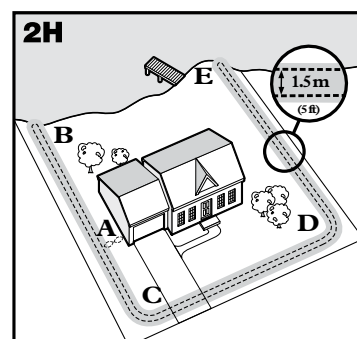

Sample 5 (2H): Lake Access (Double Loop)

From the Fence Transmitter, run the wire to A, A to B, make a U-turn and go to C, C to D, D to E, make a U-turn and follow your path all the way back to A keeping wire separated 1.5 m (5 ft). Twist the wire from A back to the Fence Transmitter.

Sample 6 (2J): Wire Loop Attached to Existing Fence (Double Loop)

This layout allows you to include your existing fence as part of your layout and keep your pet from jumping out or digging under your existing fence. It reduces the amount of wire which will need to be buried. Run the wire from the Fence Transmitter to **A**, **A** to **B**, **B** to **C**, **C** to **D**, **D** to **E**, **E** to **F**, make a U-turn and follow your path all the way back to **A**, keeping the wire separated 1.5 m (5 ft). Twist the wire from **A** back to the Fence Transmitter. See the "Install the Boundary Wire" section for more information on attaching the wire to a fence.

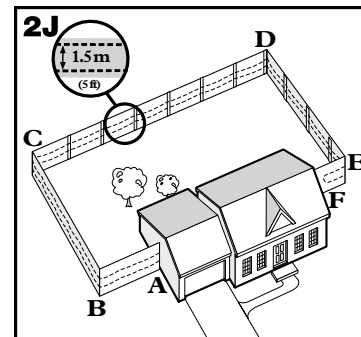

Step 3 Position the Boundary Wire

CAUTION Risk of injury. Wire on top of the ground may be a trip hazard. Use care in how you place your wires.

Lay out the Boundary Wire using your planned boundary and test the system **BEFORE** burying the wire or attaching it to an existing fence. This will make any layout changes easier. Work carefully. A nick in the wire insulation can diminish the signal strength and create a weak area where your pet can escape.

Running the Boundary Wire parallel to and within 3 m (10 ft) of electrical wires, neighbouring containment systems, telephone wires, television or antenna cables, or satellite dishes may cause an inconsistent signal. If you must cross any of these, do so at 90-degree angles (perpendicularly). (3A)

If separating the wire by at least 3 m (10 ft) from a neighbouring containment system's wire does not reduce the inconsistent signal, contact the Customer Care Centre.

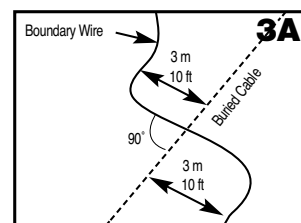

To Twist the Boundary Wire

Twisting the Boundary Wire cancels the signal and allows your pet to cross over that area without receiving a correction (3B). To ensure the signal is cancelled, it is recommended that you cut and splice the Boundary Wire between each twisted section. The signal cannot be cancelled by running the wire through plastic or metal piping. Splicing shielded cable to the Boundary Wire will also not cancel the signal. Refer to figure (3C) for the correct method for twisting the wire. You can twist your own wire by cutting two equal lengths of Boundary Wire supplied and twisting them together. Anchor one end of the wires to something secure and insert the other end in a power drill. Pull the wire taut. The drill enables you to twist the wire quickly. Twist the Boundary Wire 30 times per metre (10-12 times per foot) to cancel the signal. Once you have completed your boundary layout, insert the twisted wire into the transmitter.

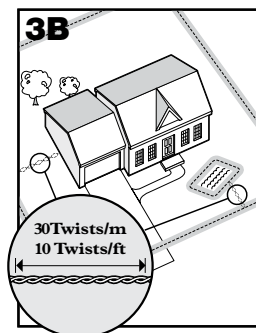

To Splice or Repair the Boundary Wire

If you need additional Boundary Wire to expand your wire loop, you will need to splice the wires together. Note the locations of all splices for future reference. Most Boundary Wire breaks occur at splices.

Strip approximately 1 cm ($\frac{3}{8}$ ") of insulation off the ends of the Boundary Wires to be spliced (3D). Make sure the copper Boundary Wire is not corroded. If the Boundary Wire is corroded, cut it back to expose clean copper wire.

Insert the stripped ends into the wire nut and twist the wire nut around the wires. Ensure that there is no copper exposed beyond the end of the wire nut. Tie a knot 7.5 cm - 10 cm (3" - 4") from the wire nut (3E). Ensure that the wire nut is secure on the wire splice.

Once you have securely spliced the wires together, open the lid of the gel-filled splice capsule and insert the wire nut as deeply as possible into the waterproof gel inside the capsule (3F). Snap the lid of the capsule shut (3G). For proper system performance, the splice connection must be waterproof.

If your splice pulls loose, the entire system will fail. Make sure your splice is secure. Additional gel-filled splice capsules and wire nuts are available through the Customer Care Centre.

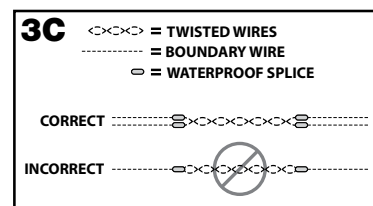

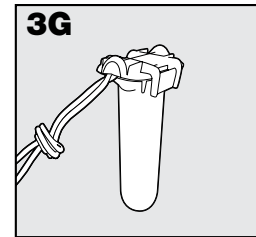
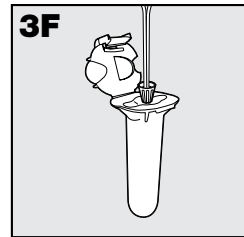
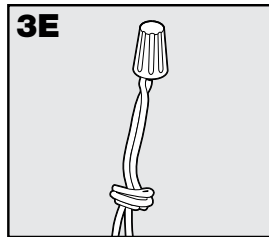
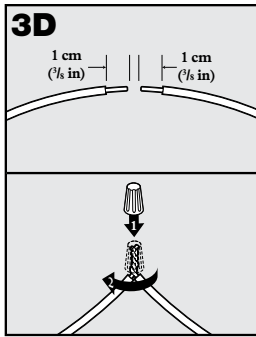

Additional Boundary Wire

Extra direct burial Boundary Wire can be purchased in 150 m (500 feet) spools at the store where you purchased the kit or through the Customer Care Centre.

Note: When adding Boundary Wire, it must act as a continuous loop.

The table at right indicates the approximate length of Boundary Wire needed for a square, Single Loop layout. Length will vary due to the amount of twisted wire and layout used. Remember that a Double Loop will require twice as much wire.

Area to be enclosed			Approximate wire length required	
Ar	Ac	Ha	M	Ft
10	1/4	0.10	127	415
13	1/3	0.13	146	480
20	1/2	0.20	180	590
40	1	0.40	255	835
80	2	0.80	360	1180
200	5	2	570	1870
400	10	4	854	2800

Step 4 Connect the Wires to the Fence Transmitter

Boundary Wire (4A)

1. Run the Boundary Wire to the Fence Transmitter through a window, under a door, through a crawl space vent, or any other appropriate available access. You can also drill a hole through your wall.
2. Strip the ends of the Boundary Wire approximately 1 cm (3/8").
3. Insert the Boundary Wires into the Boundary Wire Terminals on the Fence Transmitter. Make sure the wires do not touch each other at the terminals.
4. Turn the Boundary Width Control knob to 10. This will set the Warning Zone at the maximum width.
5. Plug the Power Adapter into the Power Socket and a working outlet. The Power Adapter comes with the North American plug installed and additional plugs for the UK, Europe, and Australia. To change the plug:
 - a. Push in the tab on the Power Adapter and remove the plug by sliding it off as shown (4B).
 - b. Slide the proper plug for your electrical outlet onto the Power Adapter as shown (4C).
6. The Power Light and Loop Indicator Lights should come on. If this does not happen, see the "Troubleshooting" section.

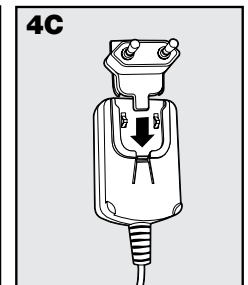
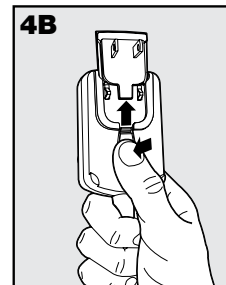
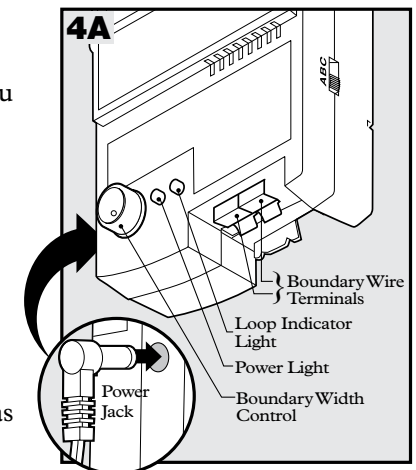

⚠WARNING Do not install, connect, or remove your system during a lightning storm. If the storm is close enough for you to hear thunder, it is close enough to create hazardous surges. Risk of electric shock. Use the fence transmitter indoors in a dry location only.

⚠CAUTION If possible, DO NOT use an outlet protected with a Residual Current Device (RCD) or Ground Fault Circuit Interrupter (GFCI). The fence system will function properly, but in rare cases, nearby lightning strikes may cause the RCD or GFCI to trip. Without power, your pet may be vulnerable to escape. You will have to reset the RCD or GFCI to restore power to the system.

⚠NOTICE For added protection for the Fence Transmitter when unused for long periods of time or prior to thunderstorms, disconnect the Loop Boundary Wires and unplug the Power Adapter from the outlet. This will prevent damage to the Transmitter due to surges.

Step 5 Prepare the Receiver Collar (PIG19-10763)

There are two sets of Contact Points that can be used on your receiver. Your Receiver Collar comes with the short Contact Points installed. The longer Contact Points should be used on dogs with long hair. Tighten the Contact Points using Test Light Tool (5A) one-half turn beyond finger tight. Check the tightness weekly.

To Insert and Remove the Battery

Note: Do not install the battery while the Collar Receiver is on your pet.

1. Remove the screws with a Philips screwdriver.
2. Remove the Battery Lid (5B).
3. Install a 9-volt alkaline battery (5C).
4. Replace the Battery Lid (5C).
5. Reinstall the screws. Do not over-tighten the screws.

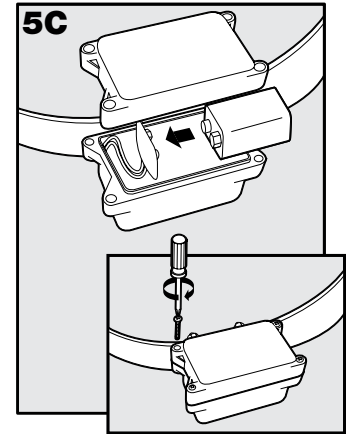
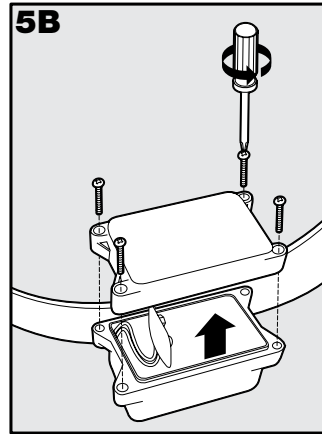
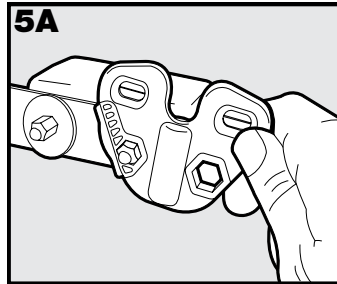

Replacement 9-volt alkaline batteries can be found at many retailers.

To Set the Correction Level

Read all steps before attempting to set the Correction Level.

1. Remove the clear plastic cover with the edge of the Test Light Tool to expose the Correction Level Button (5D).
2. With the battery installed, press the Correction Level Button and release when the Receiver Indicator Light lights up (5E).
3. The Receiver Indicator Light will emit a series of flashes representing the Correction Level.
4. Increase the Correction Level by pressing and releasing the Correction Level Button within 5 seconds of the previous series of flashes.
5. After setting the Correction Level, replace the cover to protect the Correction Level Button.

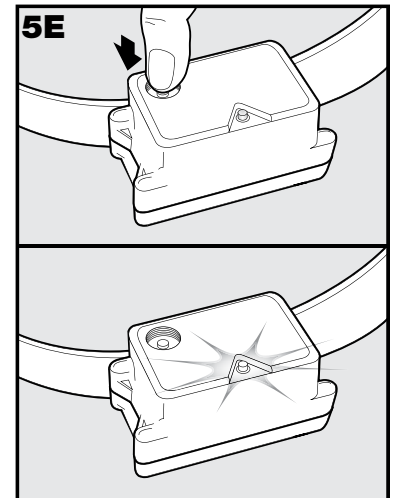
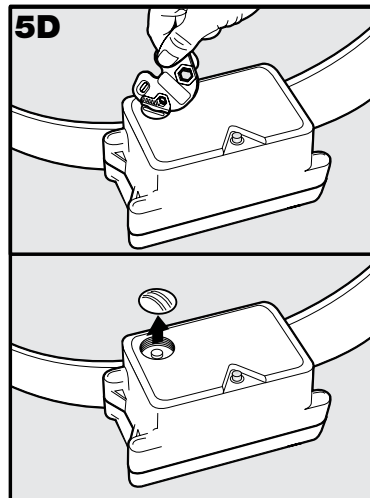

The Correction Levels increase in strength from 1 to 5. Pushing the Correction Level Button while the Receiver Collar is on level 5 will cause the Receiver Collar to revert to level 1. Refer to the Function and Response Table to choose the Correction Level that best fits your pet.

The Receiver Collar will emit a Warning Tone and vibrate whenever your pet enters the Warning Zone, no matter what correction level the Receiver is set to. If your pet continues into the Correction Zone, and the Receiver Collar is set to level 2 or above, he will receive a Static Correction. The Receiver Collar is equipped to automatically increase the level of Static Correction the longer your pet remains in the Static Correction Zone if the Receiver is set at level 2 or above.

The Receiver Indicator Light acts as a low battery indicator, flashing every 5 seconds when battery replacement is required. Test your Receiver Collar at least once a month to verify that it is functioning properly and that it activates the Boundary Wire.

Over Correction Protection

In the unlikely event that your pet “freezes” in the Static Correction Zone, this feature limits the static correction duration to a maximum of 30 seconds. While the system locks out further static correction, the warning tone will continue until the pet leaves the Static Correction Zone.

Function and Response Table

Indicator Light Response	Correction Level	Collar Receiver Function	Temperament of Pet
1 Flash	1	Tone and Vibrate (No Static Correction)	Initial Training Mode
2 Flashes	2	Low Static Correction	Timid
3 Flashes	3	Medium Static Correction	Timid or Average
4 Flashes	4	Medium High Static Correction	Average or High Energy
5 Flashes	5	High Static Correction	High Energy
Flashes once every 5 seconds		Low Battery	

Step 6 Set the Boundary Width and Test the Receiver Collar

The Boundary Control Switch on the side of the Fence Transmitter has three settings (6A). Setting B is used for most properties. The following table will indicate the setting you should use.

Amount of Wire	Setting
Up to 396 m (1300 ft)	B
396 m - 732 m (1300 ft - 2400 ft)	C
Greater than 732 m (2400 ft)	A

Use the Boundary Width Control knob to set the width of the Warning Zone and Static Correction Zone (6B). Set the Boundary Width as wide as possible to give your pet the widest Warning and Static Correction Zones without reducing the Pet Area too much. We recommend a 3.7 m - 6 m (12 ft - 20 ft) Boundary Width.

Note: The Boundary Width Control knob does not change the Static Correction Level.

CAUTION To prevent an unintended correction:

- The receiver collar should not be on your dog when the system is tested.
- Remove the receiver collar before making any changes to your system.
- Before placing the receiver collar on your pet, test the boundary location and width after any change.

To identify the Warning and Static Correction Zones, make sure the Receiver Collar battery is properly installed and the Test Light Contacts are touching the Contact Points (6C, 6D). For best results, select a section of straight Boundary Wire that is at least 15 m (50 ft) long. Hold the Test Light contacts to the Contact Points. (6D).

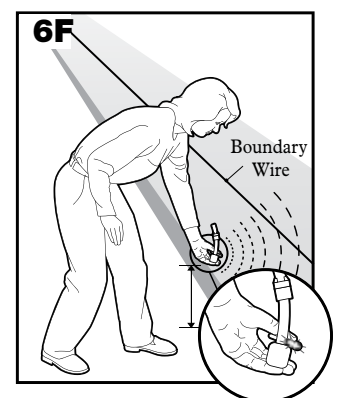
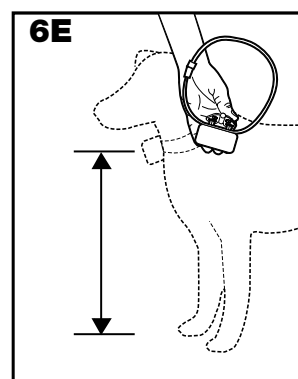
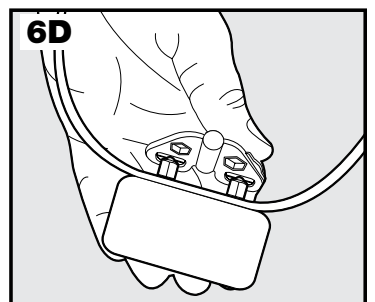
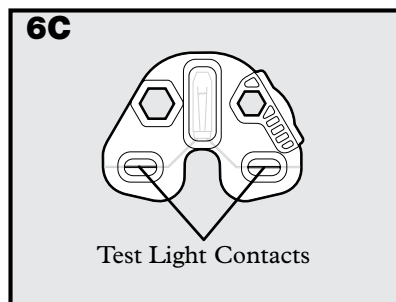
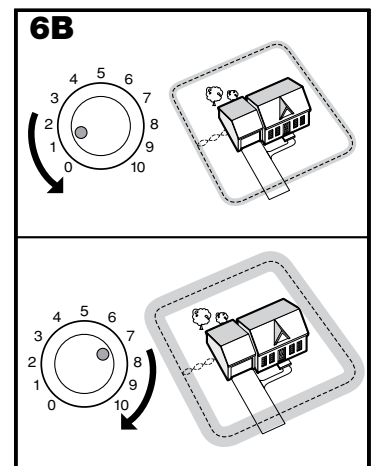
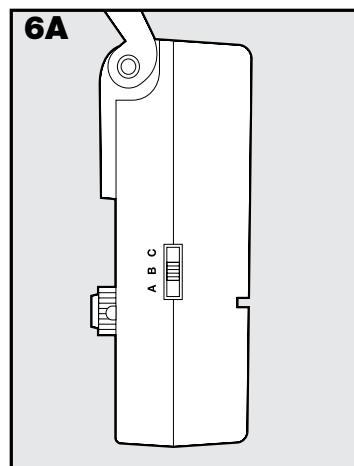

Walk toward the Boundary Wire with Contact Points pointing up and holding the Receiver Collar at your pet's neck level (6E) until the Receiver Collar beeps and the Test Light flashes (6F).

Note: The Receiver Collar is waterproof, which can make the beep hard to hear.

If the Receiver Collar does not beep at the desired range, adjust the Boundary Width Control knob to the desired setting. Turning the Boundary Width Control knob clockwise increases the Boundary Width while turning it counterclockwise decreases it (6B). Repeat this activity as needed until the Receiver Collar beeps at the desired distance from the Boundary Wire.

Note: The flashing Test Light Tool, when held to the Contact Points, indicates the Receiver Collar is delivering Static Correction.

The numbers on the Boundary Width Control knob indicate signal strength and are not representative of Boundary Width footage. If adjusting the Boundary Width Control knob does not give the desired range, adjust the Boundary Control Switch to another setting to achieve your desired range. If using a Double Loop, you may need to increase the separation of the Boundary Wire to achieve desired range.

The Receiver Collar beeps as a warning tone and ticks when delivering a Static Correction. After hearing the beep, continue to walk towards the wire. The Receiver Collar should tick and the Test Light should flash, indicating the Static Correction as you enter the Static Correction Zone (6G). A warning tone and the flashing of the Test Light indicate that the Receiver Collar and the system are working properly. Test in a number of different areas until you are satisfied that the system is functioning properly.

Next walk all around the Pet Area to ensure there are no areas where the Receiver Collar may activate from signals coupled onto buried wires or cables. Test the collar in and around the inside or the house as well. As mentioned, cable and wires from cable TV, electrical or telephone lines may conduct pet fencing signals inside and outside the house that can activate the dog's collar accidentally. While rare, if this occurs your Boundary Wire is probably too close to these outside lines and should be moved or modified as shown in figure 3A. If you are satisfied that your system is functioning properly, you are ready to start burying the Boundary Wire. If the Receiver Collar did not beep or the Test Light did not flash, see the "Troubleshooting" section.

Note: The Boundary Width is broken down into 20% Warning Zone and 80% Static Correction Zone.

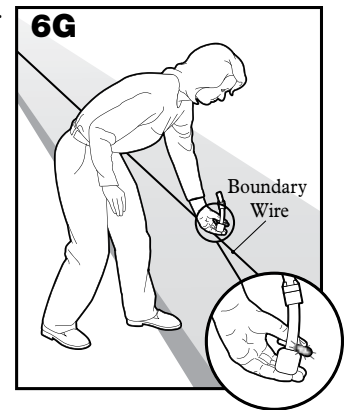

Step 7 Install the Boundary Wire

WARNING Underground cables can carry high voltage. Have all underground cables marked before you dig to bury your wire. In most areas, this is a free service.

NOTICE Avoid damage to the insulation of the loop wire during the install. Damage may cause areas of weak signal and lead to early failure of the loop (wire breaks).

Before you begin installing the Boundary Wire, turn the Fence Transmitter Off and unplug the adapter.

To Bury the Boundary Wire

Burying the Boundary Wire is recommended to protect it and prevent disabling the system.

1. Cut a trench **2.5 cm - 7.6 cm (1" - 3")** deep along your planned boundary.
2. Place the Boundary Wire into the trench maintaining some slack to allow it to expand and contract with temperature variations.
3. Use a blunt tool such as a wooden paint stick to push the Boundary Wire into the trench. Be careful not to damage the Boundary Wire insulation.

To Attach the Boundary Wire to an Existing Fence

The Boundary Wire can be attached to a chain link fence, split rail fence, or a wooden privacy fence. The Boundary Wire can be attached as high as needed. However, make sure the Boundary Width is set at a high enough range for the pet to receive the signal. If using a Double Loop with an existing fence at least 1.5 m (5 ft) tall, run the Boundary Wire on top of the fence and return it on the bottom of the fence to get the 1.5 m (5 ft) separation needed.

- **Chain Link Fence (7A):** Weave Boundary Wire through the links or use plastic quick ties.
- **Wooden Split Rail or Privacy Fence (7A):** Use staples to attach Boundary Wire. Avoid puncturing the insulation of the Boundary Wire.
- **Double Loop with an Existing Fence:** Run Boundary Wire on top of the fence and return it on the bottom of the fence to get the 1.5 m (5 ft) separation needed.
- **Gate (Single Loop) (7B):** Bury the Boundary Wire in the ground across the gate opening.
Note: The signal is still active across the gate. Your pet cannot pass through an open gate.
- **Gate (Double Loop) (7B):** Bury both Boundary Wires across the gate opening while keeping them 1.5 m (5 ft) apart.

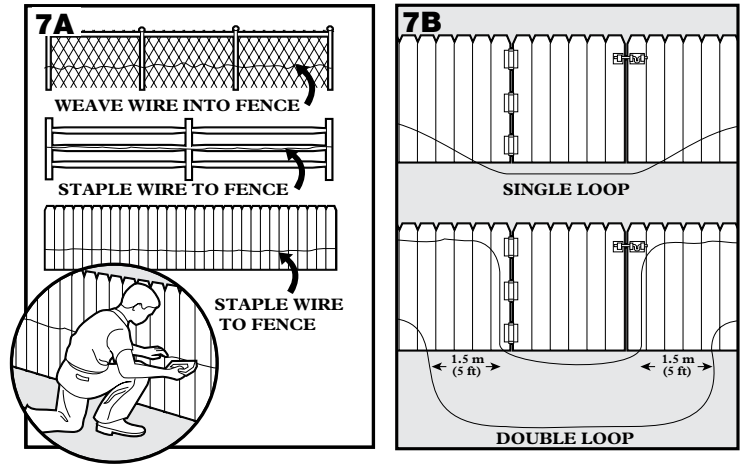

To Cross Hard Surfaces (driveways, sidewalks, etc.)

⚠ WARNING Follow all safety instructions for your power tools. Be sure to always wear your safety goggles.

- **Concrete Driveway or Sidewalk (7C):** Place the Boundary Wire in a convenient expansion joint or create a groove using a circular saw and masonry blade. Place the Boundary Wire in the groove and cover with an appropriate waterproofing compound. For best results, brush away dirt or other debris before patching.
- **Gravel or Dirt Driveway (7D):** Place the Boundary Wire in a PVC pipe or hose pipe to protect the Boundary Wire before burying.

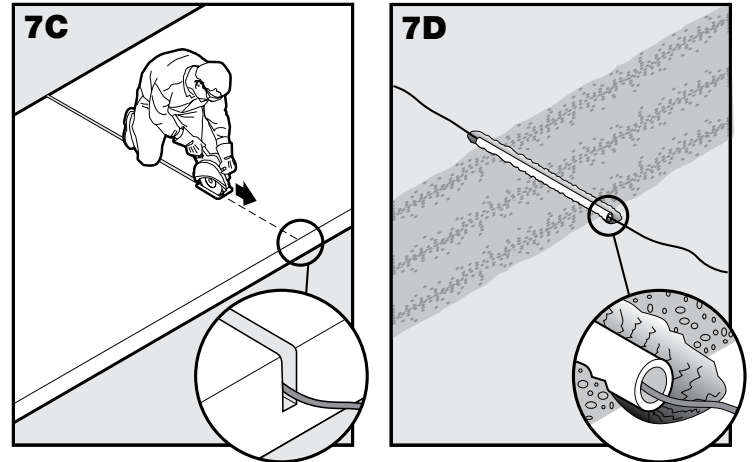

Step 8 Place the Boundary Flags

The Boundary Flags are visual reminders for your pet of where the Warning Zone is located.

1. Place the Test Light contacts on the contact points and hold the Receiver Collar at your pet's neck height.
2. Walk towards the Warning Zone until the Receiver Collar beeps (8A).
3. Place a Boundary Flag in the ground (8B).
4. Walk back into the Pet Area until the beeping stops.
5. Repeat this process around the Warning Zone until it is marked with Boundary Flags every 3 m (10 ft).

Note: If you cannot hear the beep, see the Test Light Instructions in Step 6.

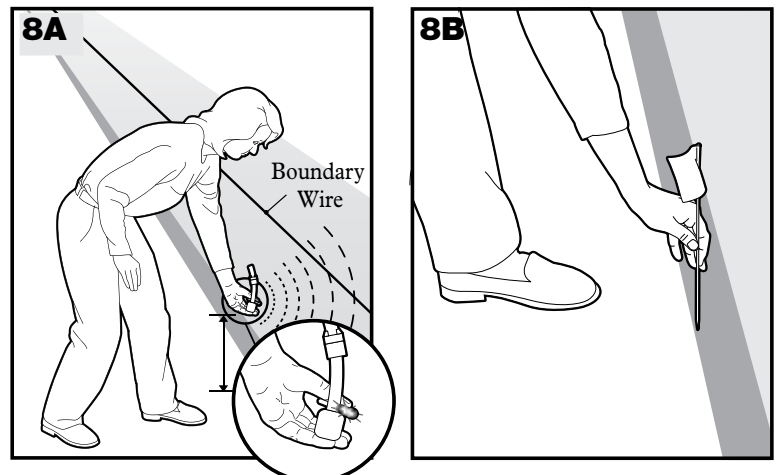

Step 9 Fit the Receiver Collar

Important: The proper fit and placement of your Receiver Collar is important for effective training. The Contact Points must have direct contact with your pet's skin on the underside of his neck.

CAUTION Please read and follow the instructions in this manual. Proper fit of the collar is important. A collar worn for too long or made too tight on the pet's neck may cause skin damage. Ranging from redness to pressure ulcers; this condition is commonly known as bed sores.

- Avoid leaving the collar on the dog for more than 12 hours per day.
- When possible reposition the collar on the pet's neck every 1 to 2 hours.
- Check the fit to prevent excessive pressure; follow the instructions in this manual.
- Never connect a lead to the electronic collar; it will cause excessive pressure on the contacts.
- When using a separate collar for a lead, don't put pressure on the electronic collar.
- Wash the dog's neck area and the contacts of the collar weekly with a damp cloth.
- Examine the contact area daily for signs of a rash or a sore.
- If a rash or sore is found, discontinue use of the collar until the skin has healed.
- If the condition persists beyond 48 hours, see your veterinarian.

For additional information on bed sores and pressure necrosis, please visit our website.

These steps will help keep your pet safe and comfortable. Millions of pets are comfortable while they wear stainless steel contacts. Some pets are sensitive to contact pressure. You may find after some time that your pet is very tolerant of the collar. If so, you may relax some of these precautions. It is important to continue daily checks of the contact area. If redness or sores are found, discontinue use until the skin has fully healed.

To assure a proper fit, please follow these steps:

1. Make sure that the battery is not installed in the Receiver Collar.
2. Start with your pet standing comfortably (9A).
3. Place the Receiver Collar on your pet so that the "PetSafe®" logo is facing your pet's chin. Centre the Contact Points underneath your pet's neck, touching the skin.

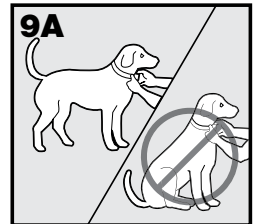

CAUTION You may need to trim the hair in the area of the Contact Probes. Never shave the dog's neck; this may lead to a rash or infection.

4. Check the tightness of the Receiver Collar by inserting one finger between the end of a Contact Point and your pet's neck. The fit should be snug but not constricting (9B).



CAUTION You should not make the collar any more tight than is required for good contact. A collar that is too tight will increase the risk of pressure necrosis in the contact area.

5. Allow your pet to wear the collar for several minutes then recheck the fit. Check the fit again as your pet becomes more comfortable with the Receiver Collar.
6. Once you are satisfied with the fit of the Receiver Collar then you may trim any excess collar strap as follows (9C):
 - a. Mark the desired length of the Receiver Collar with a pen. Allow for growth if your pet is young or grows a thick winter coat.
 - b. Remove the Receiver Collar from your pet and cut off the excess.
 - c. Before placing the Receiver Collar back onto your pet, seal the edge of the cut collar by applying a flame along the frayed edge.

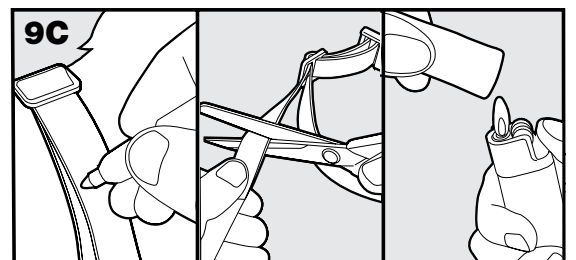

To Re-Thread the Collar

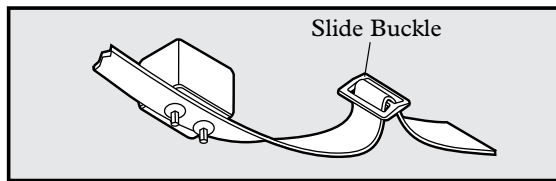

The slide buckle prevents the collar from becoming loose around your pet's neck.

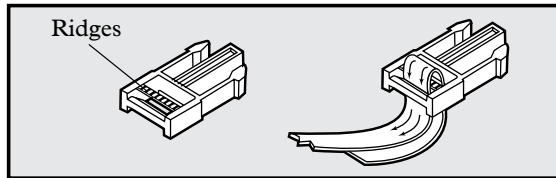

The ridges must be facing up; the collar will slip if it is not properly threaded.

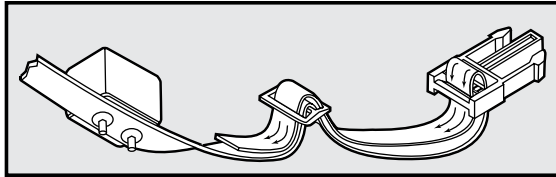

Training Guide

Be Patient With Your Pet

CAUTION Proper training of your pet is essential to the success of the PetSafe® In-Ground Fence™. During the first 2 weeks of training, do not use the training device on your pet without direct supervision. Read this section completely before beginning to train your pet.

- Have fun with your pet throughout the training process. Training should be fun, fair, firm and consistent.
- Train for 10 to 15 minutes at a time. Don't try to do too much too quickly. More-frequent short sessions are better than less-frequent longer sessions.
- If your pet shows signs of stress, slow down the training schedule, add additional days of training, or increase the amount of play time with your pet in the Pet Area. Common stress signals include:
 - Pet pulling on lead toward the house
 - Ears tucked
 - Tail down
 - Body lowered
 - Nervous / frantic movement or stiffening of pet's body
- Your pet must be completely comfortable near the Boundary Flags at the end of every training session. Spend at least 5 minutes of "play time" at the completion of each session within 3 meters (10 ft) of the Boundary Flags.
- Finish each training session on a positive note with lots of praise and play.
- Remove the Receiver Collar after each training session.
- Be sure to contain your pet by another means during the training period (e.g. pen, tie-out, lead, etc.).
- During training, if you need to take your pet out of the Pet Area, remove the Receiver Collar and either pick your pet up or put him in the car to pass out of the Pet Area.
- Even if you think your pet is responding well to the training, complete the entire training. Reinforcement is important!

Phase Day 1 - Boundary Flag Awareness

1

Tone Plus Vibration Only Training Mode

Perform three sessions on day one, each training session lasting 10-15 minutes.

Goal:

To have your pet learn that the Boundary Flags and warning beep and vibration from the Receiver Collar define the new Pet Area.

Setup:

- Program the Static Correction Level on the Receiver Collar to Level 1 Tone Plus Vibration Only Training Mode and place it on your pet's neck.
- Put a separate non-metallic collar on your pet's neck ABOVE the Receiver Collar and attach a lead.

CAUTION Be sure the extra collar does not put pressure on the Contact Points.

- Have tiny pieces of treats that your pet will find desirable available.
- Have your pet's favourite play toy available.

Steps:

1. Begin by walking your pet on a lead in the Pet Area. Calmly praise and talk to your pet.
2. Move toward the Boundary Flags (10A). Keep your mood happy.
3. With full control of your pet on a lead, walk to the flags. As your pet enters the Static Correction Zone, the Receiver Collar will begin to beep and vibrate (10B). Allow him to stay in the Static Correction Zone for 2 seconds then gently help him back into the Pet Area (10C). Immediately praise and offer your pet a treat as he enters the Pet Area, even if you have helped with the lead.
4. Repeat this process at the same Boundary Flag until your pet resists going into the Static Correction Zone.
5. Aim to master 3-4 Boundary Flags per session. Make this FUN! Praise if your pet quickly retreats or resists going into the Static Correction Zone.

Note: Never allow your pet to eat the treat in the Static Correction Zone.

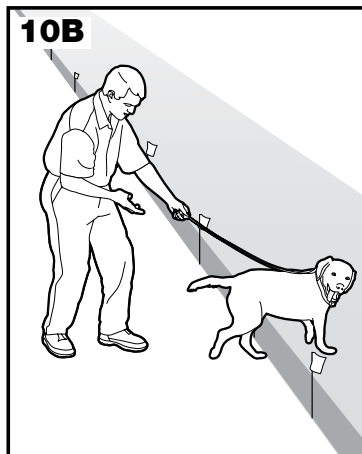
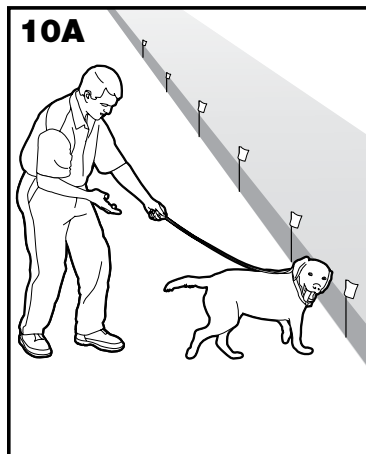

Phase Days 2 thru 4 - Continue Boundary Flag Awareness

2

Introduction to Static Correction

Perform three sessions per day, each lasting 10-15 minutes.

Goal:

To train your pet to stay in the Pet Area and respect the boundary.

Setup:

- Program the Static Correction Level on the Receiver Collar to Level 2 and place it on your pet's neck.
- Put a separate non-metallic collar on your pet's neck ABOVE the Receiver Collar and attach a lead.

CAUTION Be sure the extra collar does not put pressure on the Contact Points.

- Have tiny pieces of treats available.
- Have your pet's favourite play toy available.

Steps:

1. Repeat steps 1-5 in Phase One.
2. If your pet does not respond to the Static Correction, confirm that the Receiver Collar is fitting properly according to Step 9.
3. If the Receiver Collar is fitted properly and your pet does not respond to the Static Correction, increase the Static Correction Level by 1. Watch for slight reactions at first such as ears up, head turned, looking at the ground.
4. Stay at the same flag until your pet resists going into the Static Correction Zone.

Phase 3 Days 5 thru 8 - Distraction Phase

Perform three training sessions per day, each lasting 10 to 15 minutes.

Goal:

To train your pet to stay within the Pet Area with distractions outside of the Pet Area.

Setup:

- Program the Static Correction Level on the Receiver Collar to Level 2 or higher depending on the reaction results from days 2 thru 4.
- Put a separate non-metallic collar on your pet's neck ABOVE the Receiver Collar and attach a lead.

CAUTION Be sure the extra collar does not put pressure on the Contact Points.

- Have tiny pieces of treats available.
- Have your pet's favorite play toy available.
- Create distractions to tempt your pet to enter the Warning and Static Correction Zones, such as:
 - Have a family member cross from inside the Pet Area to outside of it.
 - Throw a ball or treat outside of the Pet Area.
 - Have a neighbor walk their pet outside of the Pet Area.
- Gradually increase distraction level.

Never coax or call your pet out of the Pet Area.

Steps:

1. With full control of your pet on a lead, have the distraction presented.
2. If your pet does not move toward the distraction, praise and offer a treat.
3. If your pet does react to the distraction, allow him to go into the Static Correction Zone.
4. Help your pet back into the Pet Area if he does not turn back after 2 seconds.
5. Treat and praise your pet anytime he comes back into the Pet Area with or without help.
6. Repeat this process with other distractions. Use other family members during this process.
7. If your pet does not respond to the Static Correction, confirm that the Receiver Collar is fitting properly according to Step 9.
8. If the Receiver Collar is fitted properly and if your pet does not respond to the Static Correction, increase the Static Correction Level by 1.

Phase 4 Days 9 thru 14 - Off-Lead Supervision

Training sessions should start at 10-15 minutes, gradually increasing to over an hour.

Your pet is ready for this step only when he clearly avoids the entire Boundary Flag line, regardless of any distractions or temptations. During this step, do not leave your pet unattended.

Goal:

To give your pet free run of the Pet Area off the lead.

Setup:

Adjust the Static Correction Level on the Receiver Collar to the permanent setting appropriate for your pet.

Steps:

1. Enter the pet area with your pet wearing the Receiver Collar.
2. Walk around the garden and play with your pet, staying within the Pet Area at all times.
3. Preoccupy yourself with another task in the garden while watching your pet.
4. Should your pet escape, take the Receiver Collar off or turn the system off at the Fence Transmitter and lead him back into the Pet Area.

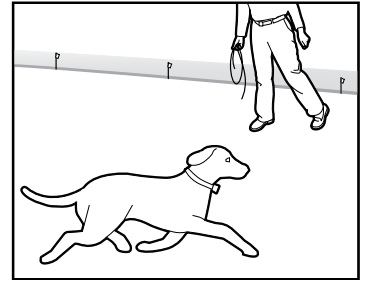

Phase 5 Days 15 thru 30 - Pet Monitoring

5

Your pet is ready to run! Check in on your pet at regular intervals.

After you are satisfied your pet's training is complete, remove every other Boundary Flag every 4 days until all flags are removed. Save Boundary Flags for future use.

Phase 6 Days 31+ Tone Plus Vibration Only Training

6

Once you have completed training, you may want to switch to the Tone Plus Vibration Only mode. Your pet should now understand the Tone Plus Vibration and respond quickly as to avoid getting into the Static Correction Zone.

Note: You may want to do a refresher course once a month, or at least every other month with your pet by setting the collar back to the tone correction mode and following the earlier phases of training. This will help your pet through continual training to be well maintained in the Pet Area.

Taking Your Pet Out of the Pet Area

Important: Remove the Receiver Collar and leave it in the Pet Area.

Once your pet learns the Boundary Zone, he will be reluctant to cross it for walks or car rides.

Option 1: Replace the Receiver Collar with a regular collar. Put your pet in a car that is within the Pet Area and drive him out of the Pet Area.

Option 2: Replace the Receiver Collar with a regular collar and lead. Walk your pet out of the Pet Area while giving a command such as "OK" at a specific place of the Boundary Zone (the end of your driveway, sidewalk, etc.). Always leave the Pet Area with a lead at this place and your pet will associate leaving the Pet Area only on a lead, only at this place, and only with a person. You may initially need to convince your pet to leave the Pet Area with a food treat and lots of praise.

Note: You may also carry your pet out of the Pet Area.

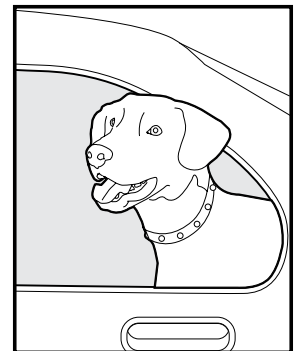

Congratulations! You have now successfully completed the training program.

Accessories

To purchase additional accessories for your PetSafe® Stubborn Dog In-Ground Fence™, visit our website at www.petsafe.net to locate a retailer near you and for a listing of Customer Care Centre telephone numbers in your area.

Component	Part Number
Replacement Receiver Collar Battery	PAC11-12067
Power Adapter for the Fence Transmitter	RFA-392
Replacement Collar Strap	RFA-41-1
UltraLight™ Add-A-Dog® Receiver Collar	PIG19-10761
Deluxe UltraLight™ Add-A-Dog® Receiver Collar	PIG19-10764
Stubborn Dog Add-A-Dog® Receiver Collar	PIG19-10763
Additional Boundary Flags	RFA-2
Additional Gel-filled Capsules and Wire Nuts	RFA-366
Wire & Flag Accessory Kit	PRFA-500
Accessory Pack	RFA-281
Fence Transmitter	RFA-347
Wire Break Locator	RFA-50

Add-A-Dog® Additional Receiver Collars - Instructions for Use

PIG19-10761

UltraLight™ Add-A-Dog® Receiver Collar

Prepare the Receiver Collar

There are two sets of Contact Points that can be used on your receiver. Your Receiver Collar comes with the short Contact Points installed. The longer Contact Points should be used on dogs with long hair. Tighten the Contact Points using Test Light Tool (A) one-half turn beyond finger tight. Check the tightness weekly.

To Insert and Remove the Battery

Note: Do not install the battery while the Receiver Collar is on your pet.

This Receiver Collar utilizes a replaceable PetSafe® battery (RFA-67D-11). This unique battery is designed to make battery replacement easier and increase water protection.

To insert the battery, align the symbols on the battery (arrow) and Receiver Collar (triangle) (B). Use the edge of the Test Light Tool to turn the battery clockwise until the arrow lines up with the lock symbol on the housing.

To remove the battery, turn the battery counter-clockwise using the edge of the Test Light Tool (C).

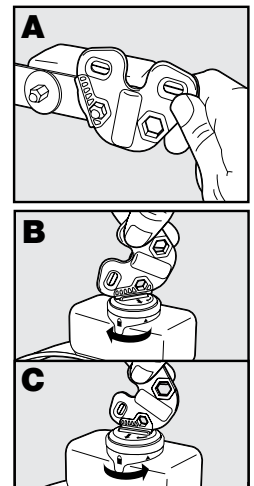

⚠ WARNING DO NOT attempt to cut into or pry open the battery. Be sure to discard the used battery properly.

Battery life will vary depending on how often your pet tests the system and receives a Static Correction. Check the Receiver Collar every month to ensure the battery is working properly.

A replacement PetSafe® battery (RFA-67D-11) can be found at many retailers. Contact the Customer Care Centre or visit our web site at www.petsafe.net to locate a retailer near you.

PIG19-10764

Deluxe UltraLight™ Add-A-Dog® Receiver Collar

This unit has 4 adjustable levels of Correction plus a Tone Only mode.

Prepare the Receiver Collar

There are two sets of Contact Points that can be used on your receiver. Your Receiver Collar comes with the short Contact Points installed. The longer Contact Points should be used on dogs with long hair. Tighten the Contact Points using the Test Light Tool (A) to one-half turn beyond finger tight. Check the tightness weekly.

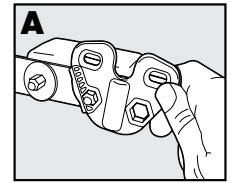

To Insert and Remove the Battery

Note: Do not install the battery while the Receiver Collar is on your pet.

This Receiver Collar utilizes a replaceable PetSafe® battery (RFA-67D-11). This unique battery is designed to make battery replacement easier and increase water protection.

To insert the battery, align the symbols on the battery (arrow) and Receiver Collar (triangle) (B). Use the edge of the Test Light Tool to turn the battery clockwise until the arrow lines up with the lock symbol on the housing.

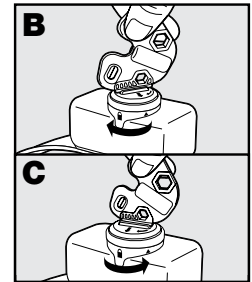

To remove the battery, turn the battery counter-clockwise using the edge of the Test Light Tool (C).

WARNING DO NOT attempt to cut into or pry open the battery. Be sure to discard the used battery properly.

Battery life will vary depending on how often your pet tests the system and receives a Static Correction. Check the Receiver Collar every month to ensure the battery is working properly.

A replacement PetSafe® battery (RFA-67D-11) can be found at many retailers. Contact the Customer Care Centre or visit our web site at www.petsafe.net to locate a retailer near you.

To Set the Static Correction Level

Read all steps before attempting to set the Static Correction Level.

1. Remove the clear plastic cover with the Test Light Tool to expose the Correction Level Button (D).
2. With the battery installed, press the Correction Level Button and release when the Receiver Indicator Light comes on (E).
3. The Receiver Indicator Light will emit a series of flashes representing the Static Correction Level.
4. Increase the Static Correction Level by pressing and releasing the Correction Level Button within 5 seconds of the previous series of flashes.
5. After setting the Static Correction Level, replace the cover to protect the Correction Level Button.

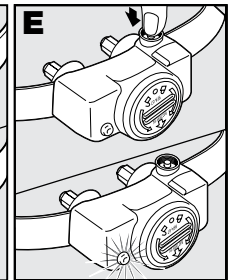
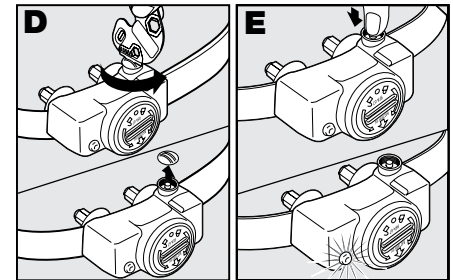

The Static Correction levels increase in strength from 1 to 5. Pushing the Correction Level Button while the Receiver Collar is on level 5 will cause the Receiver Collar to revert to Level 1. Refer to the Function and Response Table to choose the Static Correction level that best fits your pet.

The Receiver Collar is equipped to automatically increase the level of Static Correction the longer your pet remains in the Static Correction Zone if the collar is set at level 2 or above.

The Receiver LED Indicator Light acts as a low battery indicator, flashing every 4 to 5 seconds when replacement is required.

Function and Response Table

Indicator Light Response	Static Correction Level	Receiver Collar Function	Temperament of Pet
1 Flash	1	No Static Correction, Tone Only	Initial Training Mode
2 Flashes	2	Low Static Correction	Timid
3 Flashes	3	Medium Static Correction	Timid or Average
4 Flashes	4	Medium High Static Correction	Average or High Energy
5 Flashes	5	High Static Correction	High Energy
Flashes once every 4 to 5 seconds		Indicates Low Battery	

Frequently Asked Questions

Will it work in my garden?	Yes. The PetSafe® Stubborn Dog In-Ground Fence™ works in gardens up to 10 acres (400 ares). Additional wire and flag kits may need to be purchased. These are sold separately.
Will it hurt my pet?	No. The Static Correction is delivered when your pet crosses the established boundary. It is designed to get your pet's attention, but not punish him. This method has been proven safe and will not harm your pet.
Can my children get hurt?	No. The Static Correction is produced by the Contact Points on the Receiver Collar, not the Boundary Wire. With proper use, the system is safe for all.
I have a small pet and a large pet; will this work for me?	Yes. Since the PetSafe® Stubborn Dog In-Ground Fence™ provides adjustable Static Correction, it is safe and effective for pets over 3.6 kg (8 lbs). The system includes one Receiver Collar; additional Receiver Collars are sold separately.
Can I use the system with an existing fence?	Yes. The system can be used with an existing fence if you have a problem with your pet digging under or jumping over a traditional fence.
How often will my pet receive a Static Correction?	When trained properly, most pets will only receive a few Static Corrections during normal usage.
How old does my pet have to be before starting training on the PetSafe® Stubborn Dog In-Ground Fence™?	Because all pets are different, training on this system can be started once your pet can learn basic obedience commands like "sit" and "stay". The system should only be used with pets who are over 6 months of age. If your pet is injured or its mobility is otherwise impaired, contact your veterinarian or professional trainer before use.

Troubleshooting

<p>Receiver Collar is not beeping or correcting.</p>	<ul style="list-style-type: none"> • Check battery to make sure it is installed properly. • Check that both lights are lit on the Fence Transmitter. If not, perform the “Short Loop Test”.
<p>The Receiver Collar is beeping, but the pet is not responding to the Static Correction.</p>	<ul style="list-style-type: none"> • Make sure the Static Correction Level is set to level 2, 3, 4 or 5. • Test the Receiver Collar with the Test Light walking toward the Boundary Wire. • If the Test Light flashes, check the fit of the Receiver Collar. • Trim your pet’s fur where the Contact Points touch the neck and/or use the longer Contact Points included in the system. • Increase the Static Correction Level. • Repeat training steps to reinforce training.
<p>The Receiver Collar has to be held on top of the Boundary Wire to activate.</p>	<ul style="list-style-type: none"> • Replace battery. • Adjust Boundary Width Control knob clockwise to increase the distance from the Boundary Wire that the Receiver Collar activates. You can also adjust the Boundary Control Switch to another setting. • If using a Double Loop, make sure Boundary Wires are separated 1.5 m (5 ft). • If the Receiver Collar still has to be held on top of the Boundary Wire, perform the “Short Loop Test”.
<p>The Receiver Collar activates inside the house.</p>	<ul style="list-style-type: none"> • Turn the Boundary Width Control knob counterclockwise to decrease the distance from the Boundary Wire that the Receiver Collar activates. • Make sure the Boundary Wire is not running too close to the house. The signal can transmit through the walls of your house. • Make sure Boundary Wires are twisted from Boundary to the Fence Transmitter.
<p>I have an inconsistent signal.</p>	<ul style="list-style-type: none"> • Make sure Fence Transmitter is at least 1 m (3 ft) from large metal objects or appliances. • Make sure all Boundary Wire turns are gradual (minimum 1 m (3 ft) radius). • Make sure the Boundary Wire is not running parallel to and within 1.5 m (5 ft) of electrical wires, neighbouring containment systems, telephone wires, television or antenna cables, or satellite dishes. • If a neighbouring containment system may be causing an inconsistent signal, contact the Customer Care Centre to see if a different frequency system will help your situation.
<p>The Power and Loop Indicator Lights are off.</p>	<ul style="list-style-type: none"> • Check that the Power Adapter is plugged into the Fence Transmitter. • Try plugging into another standard outlet. • If the lights still do not come on, the Fence Transmitter and/or the Power Adapter needs to be replaced. Contact the Customer Care Centre.
<p>The Power Light is on, the Loop Indicator Light is off, and the Fence Transmitter loop alarm is sounding.</p>	<ul style="list-style-type: none"> • Make sure both ends of the Boundary Wire are plugged into Boundary Wire Terminals and that 1 cm ($\frac{3}{8}$") of the insulation is stripped so that the copper wire is exposed. • Make sure the Boundary Wire is not cut off or pinched by a window, door, or garage door. • Perform the “Short Loop Test” to determine if the Fence Transmitter needs to be replaced or if the Boundary Wire is broken. • If the Fence Transmitter is functioning properly, you have a break in your Boundary Wire. See the “Locating a Break in the Wire” section in this guide.

Additional Information

- The system should only be used with healthy pets who are over 6 months of age. Contact your veterinarian if you have concerns about the medical condition of your pet (medication, pregnant, heart conditions, etc.).
- The PetSafe® Stubborn Dog In-Ground Fence™ is for residential use only.
- The Static Correction will get your pet's attention, but will not cause harm. It is designed to startle, not to punish.
- Test the Receiver Collar at least once a month to verify that it is functioning properly. Check that it activates at the Boundary Wire. Battery life depends upon how often the Receiver Collar is activated.
- Remove the Receiver Collar from your pet when indoors for the comfort of your pet.

Short Loop Test

The Short Loop Test is a simple test to determine if each component (Fence Transmitter, Receiver Collar and Boundary Wire) is functioning properly.

1. Disconnect the Boundary Wire.
2. Cut approximately 3 m (10 ft) of unused Boundary Wire and connect it to the Boundary Wire Terminals.
3. Spread the Boundary Wire out into a circle. Set the Boundary Control Switch to **B**.
4. Set the Boundary Width Control knob to 10.
5. If the Loop Indicator Light is not lit, then your Fence Transmitter is not functioning properly. Contact the Customer Care Centre.
6. If the Loop Indicator Light is lit, disconnect one end of the Boundary Wire from the Boundary Wire Terminal.
7. If the loop alarm does not sound, the Fence Transmitter needs to be replaced. Contact the Customer Care Centre.
8. If the loop alarm does sound, plug the Boundary Wire back into the Boundary Wire Terminal.
9. Hold the Test Light Contacts to the Receiver Contact Points. Hold the Receiver Collar next to the 3 m (10 ft) length of Boundary Wire. The Receiver Collar should beep about one foot away from the Boundary Wire. The Test Light should then flash as you hold the Receiver Collar closer to the Boundary Wire.
10. If Receiver Collar does not beep and the Test Light does not flash, replace the battery in the Receiver Collar. If it still does not beep and the Test Light does not flash, contact the Customer Care Centre.
11. If the Receiver Collar beeps, there may be a complete or partial break in the Boundary Wire. See the "To Locate a Break in the Boundary Wire" section.

To Locate a Break in the Boundary Wire

Please follow these steps in determining where you have a break in your Boundary Wire:

1. Locate your original splice(s) and verify they have a good, solid connection.
2. Check your garden to determine any possible damage to the Boundary Wire (e.g. recent digging, aerating, rodent burrowing, or any other noticeable disturbance in your yard next to the Boundary Wire).

If you still cannot find the break in the Boundary Wire, there are two options for locating it:

Option 1: Contact the Customer Care Centre to purchase a Wire Break Locator that will locate the break in the Boundary Wire.

Option 2: Follow the procedure below:

1. Unplug the Fence Transmitter.
2. Connect both ends of your twisted Boundary Wire to one Boundary Wire Terminal.
3. Measure and cut a Test Wire which is half the length of your total Boundary Wire footage.
4. Connect one end of Test Wire to the other Boundary Wire Terminal.
5. Locate the halfway point of your boundary and cut the Boundary Wire.
6. Splice the other end of the Test Wire to either side of your Boundary Wire where you cut it in half.
7. Plug in the Fence Transmitter and check the Loop Indicator Light. If the Loop Indicator Light is on, you can assume the break is in the other half of the Boundary Wire.
8. If the Loop Indicator Light did not come on, you may assume there is a break in this portion of the Boundary Wire. However, there is a small chance of having more than one break in your system. Be sure to check both halves of your entire loop.
9. Replace the damaged Boundary Wire with new Boundary Wire.
10. Reconnect the Boundary Wire to the Fence Transmitter.
11. Check the Loop Indicator Light. If the Loop Indicator Light is on, test the system with the Receiver Collar.

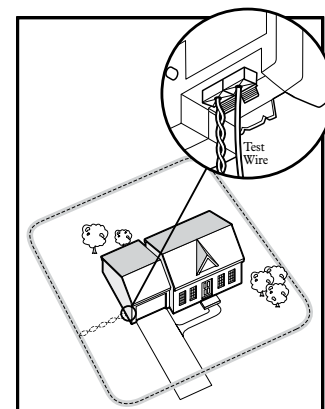

Terms of Use and Limitation of Liability

1. Terms of Use

Use of this Product is subject to your acceptance without modification of the terms, conditions and notices contained herein. Use of this Product implies acceptance of all such terms, conditions and notices. If you do not wish to accept these terms, conditions, and notices, please return the Product, unused, in its original packaging and at your own cost and risk to the relevant Customer Care Centre together with proof of purchase for a full refund.

2. Proper Use

This Product is designed for use with pets where training is desired. The specific temperament or size/weight of your pet may not be suitable for this Product (please refer to “How the System Works” in this Operating Guide). Radio Systems® Corporation recommends that this Product is not used if your pet is aggressive and accepts no liability for determining suitability in individual cases. If you are unsure whether this Product is appropriate for your pet, please consult your veterinarian or certified trainer prior to use. Proper use includes, without limitation, reviewing the entire Operating Guide and any specific Caution statements.

3. No Unlawful or Prohibited Use

This Product is designed for use with pets only. This pet training device is not intended to harm, injure or provoke. Using this Product in a way that is not intended could result in violation of Federal, State or local laws.

4. Limitation of Liability

In no event shall Radio Systems® Corporation or any of its associated companies be liable for (i) any indirect, punitive, incidental, special or consequential damage and/or (ii) any loss or damages whatsoever arising out of or connected with the misuse of this Product. The Purchaser assumes all risks and liability from the use of this Product to the fullest extent permissible by law. For the avoidance of doubt, nothing in this clause 4 shall limit Radio Systems® Corporation's liability for human death or personal injury or fraud or fraudulent misrepresentation.

5. Modification of Terms and Conditions

Radio Systems® Corporation reserves the right to change the terms, conditions and notices governing this Product from time to time. If such changes have been notified to you prior to your use of this Product, they shall be binding on you as if incorporated herein.

Compliance



This equipment has been tested and found to comply with the EU R&TTE Directive. Before using this equipment outside the EU countries, check with the relevant local R&TTE authority. Unauthorised changes or modifications to the equipment that are not approved by Radio Systems® Corporation may violate EU R&TTE regulations, could void the user's authority to operate the equipment, and will void the warranty.

Hereby, Radio Systems® Corporation, declares that this PRF-3004XW-20 Stubborn Dog In-Ground Fence™ is in compliance with the essential requirements and other relevant provisions of Directive 1999/5/EC.

The Declaration of Conformity can be found at: http://www.petsafe.net/customer-care/eu_docs.php.

Canada

Operation is subject to the following two conditions: (1) This device may not cause interference and (2) This device must accept any interference, including interference that may cause undesired operation of the device.

Modifications or changes could void the user's authority to operate this equipment.

This Class B digital apparatus complies with Canadian ICES-003.

Australia

This device complies with the applicable EMC requirements specified by the ACMA (Australian Communications and Media Authority).

Battery Disposal

Separate collection of spent batteries is required in many regions; check the regulations in your area before discarding spent batteries. Please see page 11 for instructions on how to remove the battery from the product for separate disposal. This device operates on one 9 Volt alkaline battery. Replace only with equivalent battery.

Important Recycling Advice

Please respect the Waste Electrical and Electronic Equipment regulations in your country. This equipment must be recycled. If you no longer require this equipment, do not place it in the normal municipal waste system. Please return it to where it was purchased in order that it can be placed in our recycling system. If this is not possible, please contact the Customer Care Centre for further information. For a listing of Customer Care Centre telephone numbers, visit our website at www.petsafe.net.

Layout Grid / Schéma d'installation / Ontwerpraster
Cuadrícula de distribución / Plantilla de montaje /
Plantilla de montaje / Udlægningsnet

**Mounting
Template**

**Modèle
de montage**

Montagesjabloon

**Plantilla
de montaje**

**Plantilla
de montaje**

Befestigungsplan

Monteringskabelon

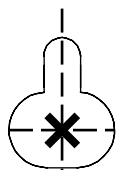
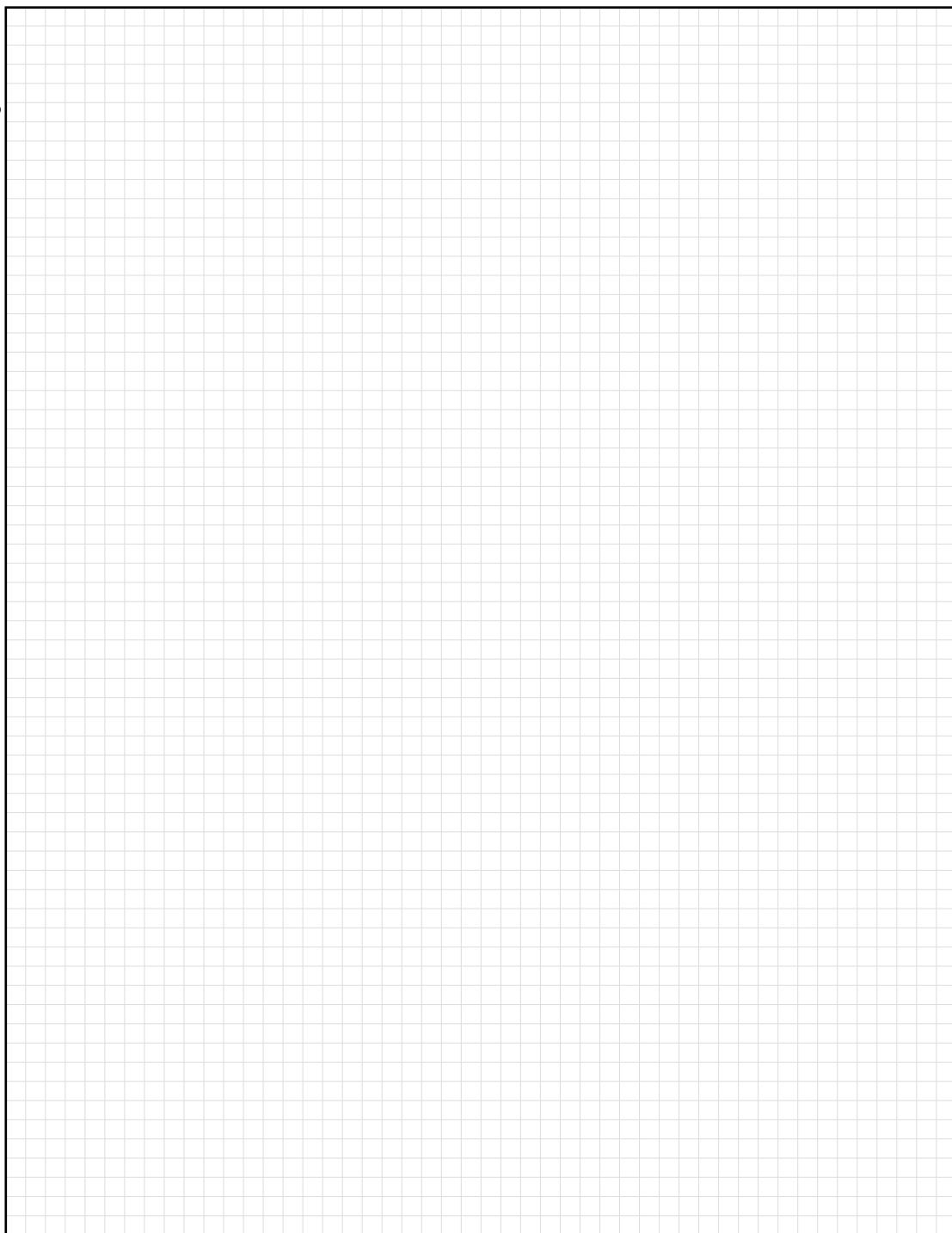

7.62 cm
7,62 cm
(3 in)

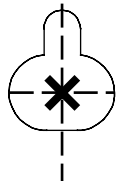

Radio Systems® Corporation
10427 Electric Avenue
Knoxville, TN 37932 USA
(865) 777-5404
www.petsafe.net
Patent Pending.
400-1195-00

©2010 Radio Systems Corporation