

PETKIT

Eversweet 3

User Manual •

Dear customer,

Thank you for purchasing our product. Please read the following instructions carefully before first use and keep this user manual for future reference. Pay particular attention to the safety instructions. If you have any questions or comments about the device, please contact the customer line.

✉ www.alza.co.uk/kontakt

☎ +44 (0)203 514 4411

Importer Alza.cz a.s., Jankovcova 1522/53, Holešovice, 170 00 Prague 7, www.alza.cz

User Notice

- Thank you for purchasing PETKIT EVERSWEET 3. PETKIT is committed to creating a better life for you and your pet with technology.
- Please read the manual carefully before use. Once the product is installed or used, it means that you have read the manual carefully and accepted the following safety instructions.
- The Company shall not be liable for any accidents or losses caused by violations, nor shall it bear any legal liability.
- The Company shall preserve the right to interpret and modify this statement.

Safety Instructions

Failure to comply with the following terms may result in failure to use the product properly or other accidental losses.

- Please install and use the drinking fountain in strict accordance with the manual.
- This device is NOT RECOMMENDED for pets within three months of age.
- Please use the device indoors.
- The device is at low voltage mode, but the pet biting of wire sill still causes electric leakage.
Please guide the pet to use properly.
- Please use the original USB power cord and original power base, otherwise it will damage the device or cause safety hazards.
- Keep the device placed horizontally, and DO NOT overturn it, otherwise it will work abnormally or spill water.
- DO NOT immerse or soak the bottom of the main device and power base of the product in water.
- If the product is not used for a long period of time or is moved, please remove batteries and unplug the power cord.
- If children use this device, be sure to use it under the guidance of adults.
- Expect for maintenance personnel, NO OTHER PERSON shall repair this product to avoid various kinds of accidental injuries.
- Be sure to check or update the battery status in the battery box before taking your vacation (this product is only applicable to alkaline batteries)
- In case of product use problems, please contact customer service in time.

Function Highlights

xSecure system

- Adhering to the concept of pet life first, the third generation of PETKIT EVERSWEET Smart Pet Drinking Fountain is equipped with an emergency power supply system, which can supply water continuously in the event of power failure with only five AAA batteries, guaranteeing the life safety of pets.
- For the operation status of the device under emergency power supply, please read the indicator light description in the battery mode fore details (page 10 on the back). At the same time, the device buzzer, water shortage indicator light, filter indicator light and battery indicator light operate properly can inform the owner of the equipment status in time.

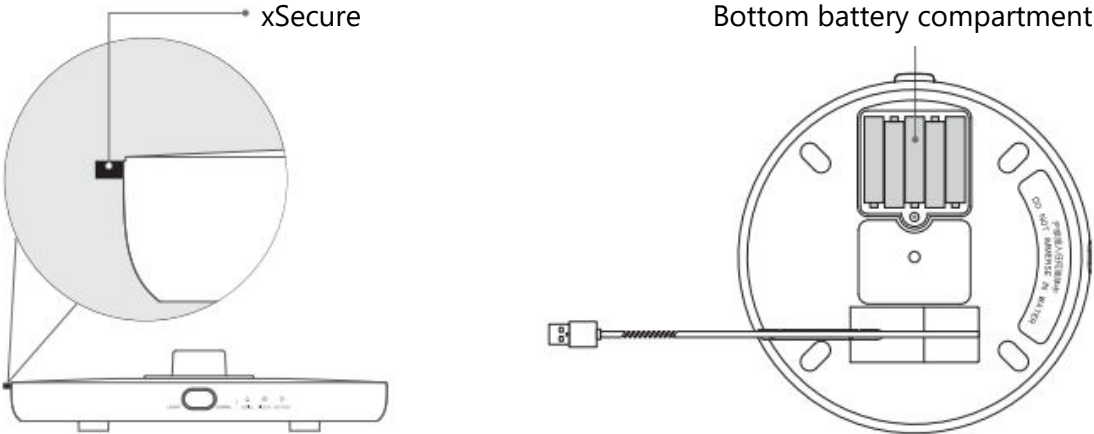

Smart fountain removing floating hair

- The function of smart fountain removing floating hair is independently developed by PETKIT for healthy water-drinking of pets.
- In direct current mode, the smart fountain pushes the floating hair on the water surface to the filter every six hours automatically (fountain for 3 seconds, stop for 2 seconds, 3 cycles, no operation at low battery power).
- It can only quickly and effectively clean the impurities on the surface of the drinking water but is also more conducive to the healthy water-drinking of pets, preventing pets swallowing too much hair.
- The fountain height will decrease in case of low water level.

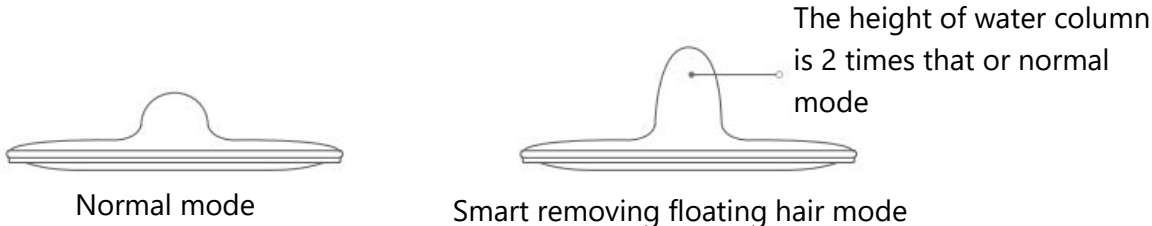

Parts List

Please confirm before installing and using the device. (The product is not equipped with batteries and the screwdriver. You need to buy them by yourself).



Drinking tray x 1

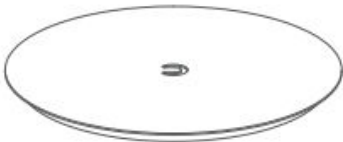

Filter x 1

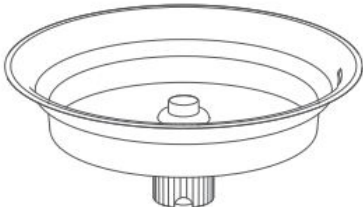

Filter tray x 1



Main body x 1

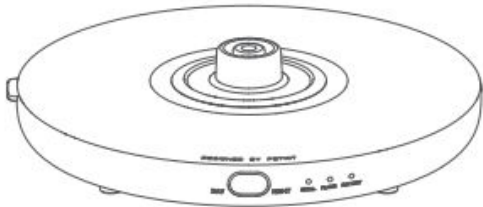

Main body base x 1

Product Introduction

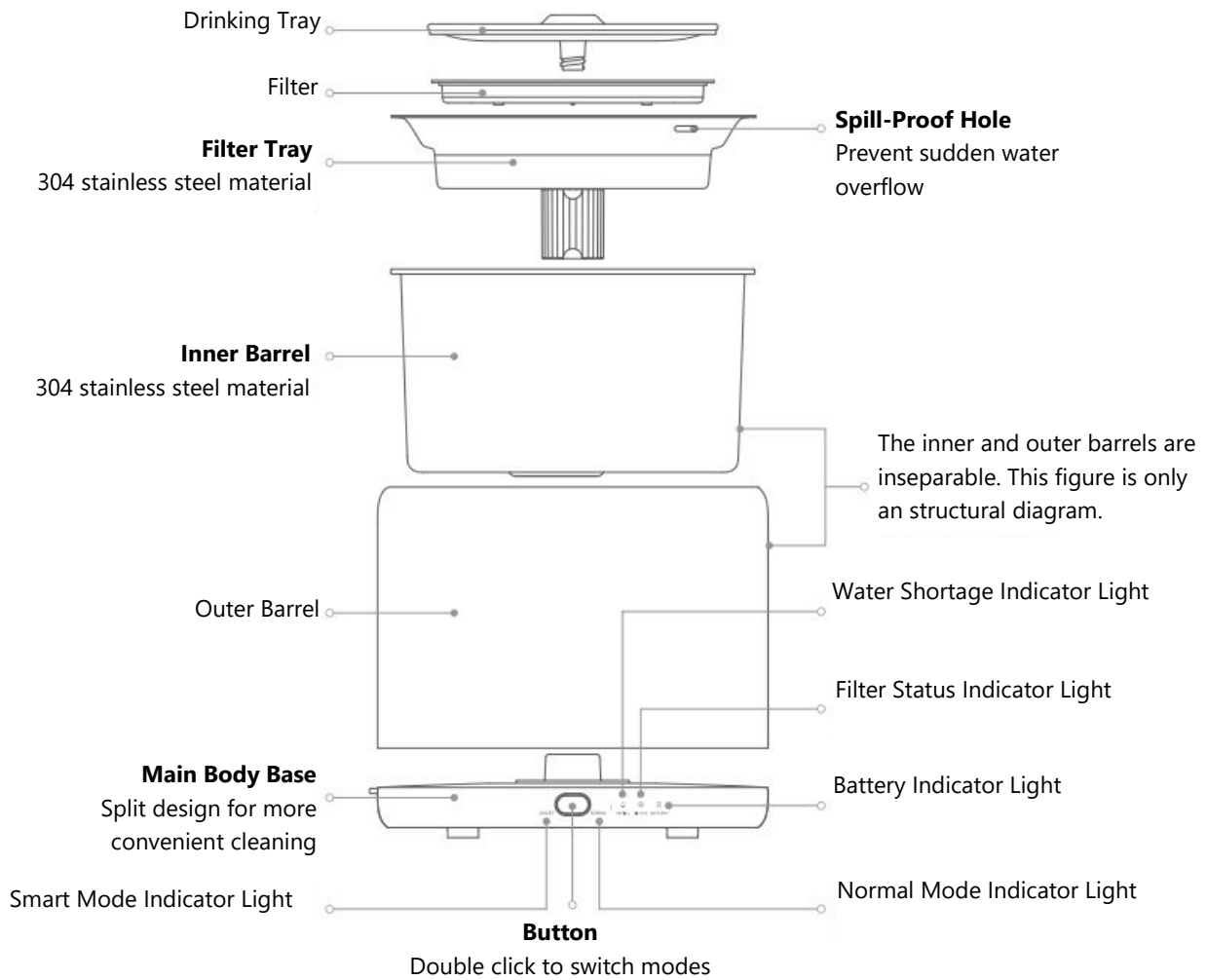

Note: When the product picture is slightly different from the actual product, the actual product shall prevail.

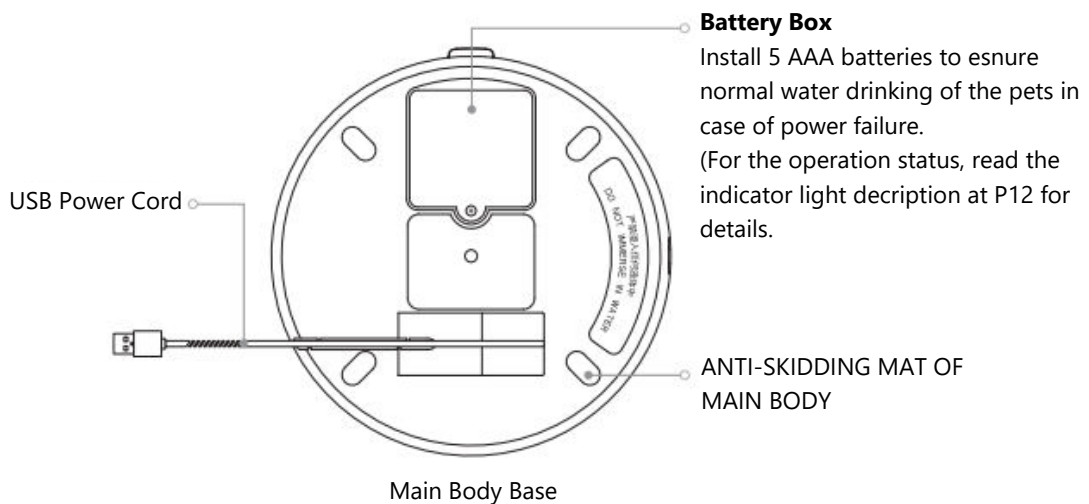

**Second Generation Of CNC
Silent Pump**

Make sure to align it with the fixed groove at the bottom of the inner barrel.

CNC Pump Wire

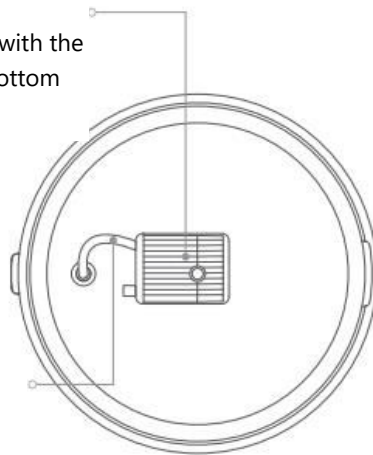

Inside the main body

Connector

DO NOT soak.
Please keep it dry.

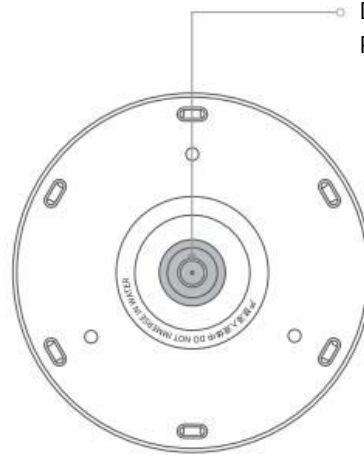

The bottom of main body

Before Installation Of The Complete Device

Take out the device

Unpack and take out the main body and all parts. (Read the parts list for details)

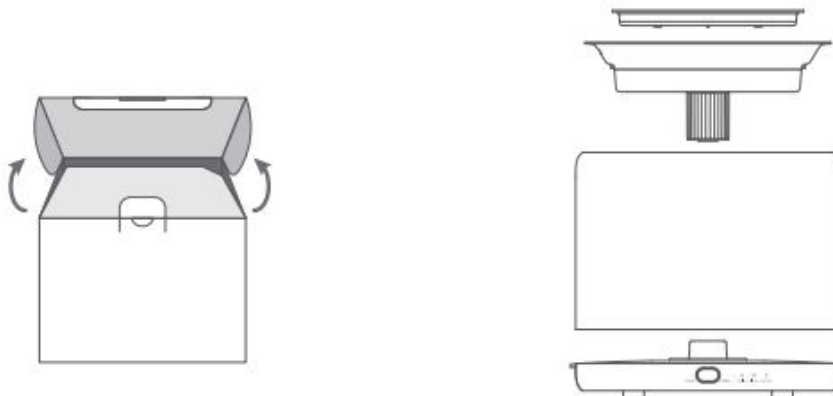

Soak the filter

Please put the filter into water and soak and clean it thoroughly before installing. (It is recommended to soak in water twice, 5 minutes each time and rinse slightly.)

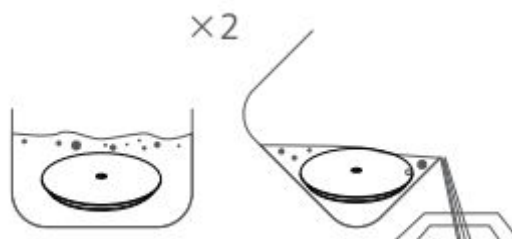

Flus the drinking tray and filter tray

Clean the tray set (drinking tray and filter tray) and the water storage barrel and internal accessories with clean water before use. (It's recommended to clean twice)

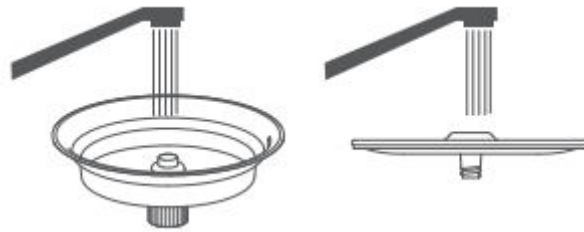

Installation of the Complete Device

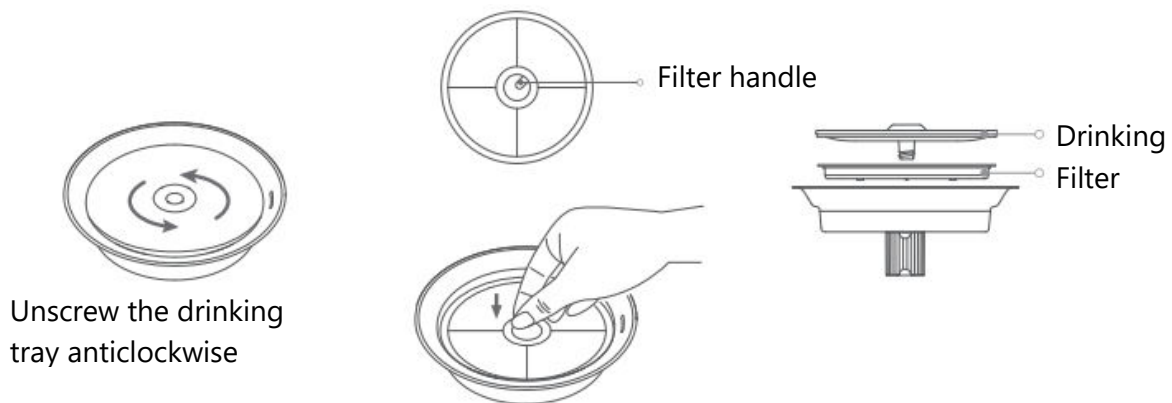

Install the filter tray assembly

1. Take out the white drinking tray and stainless steel filter tray and unscrew the white drinking tray anticlockwise.
2. Hold the handle above the center hole of the soaked filter and align it with the center hole of the filter tray to press down until it is pressed tightly.
3. Tighten the white drinking tray clockwise.

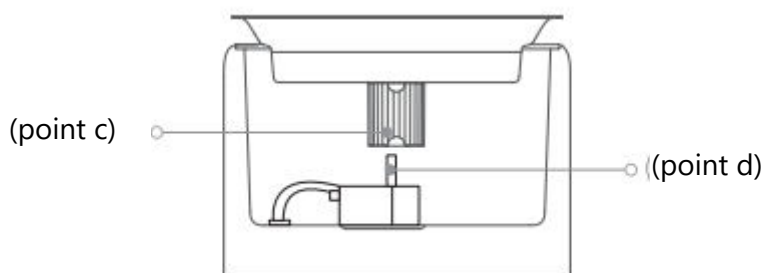

Install the filter tray assembly into the main body

First, make sure to align the silent pump with the fixed groove at the bottom. Then when placing the filter tray assembly, make sure that the outlet port (point c) at the bottom of the tray is aligned with the center of the CNC silent immersible pump port (point d) below.

Product Use

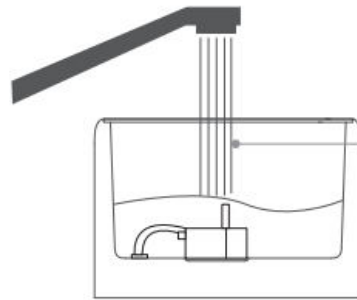
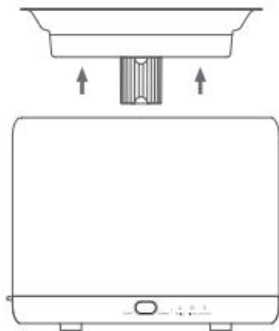

Maximum water level

Do not refill water above the maximum water level, which may result in water overflow

How to refill water

1. Move the tray assembly out of the water storage barrel. (as shown in the figure).
2. Method I: Lift the entire water storage barrel up to refill clean water to the maximum water level in the barrel. (Please ensure that the water storage barrel connector is dry)

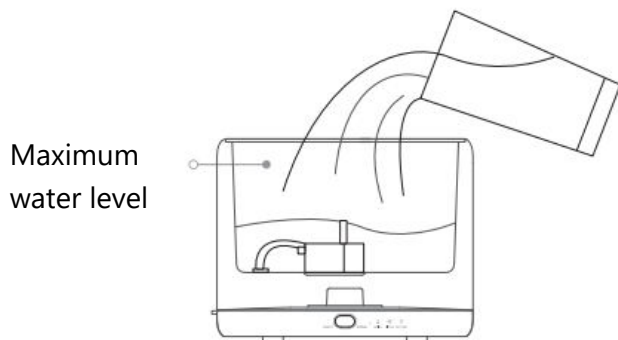

Maximum water level

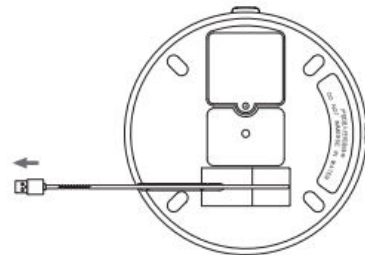





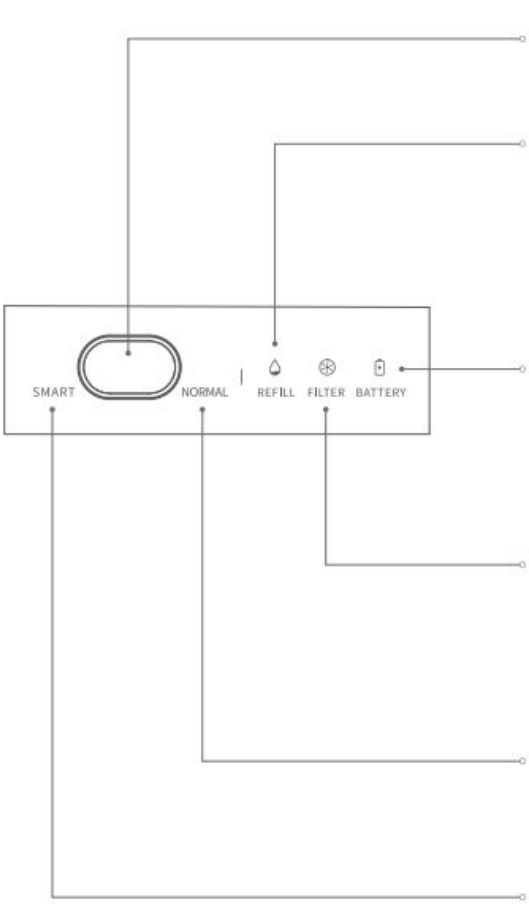

3. Method II: Do not move the water storage barrel and add clean water to the maximum water level with hand-held container.

Connect to the power supply

Please plug the USB power cord into the power supply and then the device is turned on automatically. (Self-inspection when starting. Five LED lights are on for one second and the off).

Indicator Light Description



-  **Button**
 Double click: Switch the SMART/NORMAL mode.
-  **Water shortage indicator (REFILL)**
 Red light on or flashing indicates water shortage and the equipment is in standby. The device can resume normal operation after refilling; or the upper and lower barrels are separated, and the equipment can operate properly after reinstalling.
-  **Backup battery indicator light (BATTERY)**
 Red light flashing: Low power status of backup battery.
 Green light flashing: Normal use status of backup battery.
 (Please refer to the battery mode indicator light description for details.
-  **Filter element indicator light (FILTER)**
 Red light on: indicates filter element needs replacement.
 Press and hold the button  for 5 seconds after replacement, then the red light is off, the reset is successful and the timing of filter element life will be reset.
- Normal mode (Normal)**
 Uninterrupted welling up of water
- Smart mode (SMART)**
 Fountain for 3 minutes, stop for 3 minutes.

Battery Mode Indicator Light Description

Take the new Nanfu battery as an example. This product is only applicable to alkaline batteries.

Battery capacity	Operating status	Indicator status	Working time	Remarks
New battery	Welling up about 5 seconds per minute, working in cycles	Flashing of green light	2-3 days	Can run the product smart mode to remove floating hair
More than half of the battery capacity consumed	Welling up about 5 seconds every 7 minutes, working in cycles.	Flashing of green light	4 days	Can run the product in smart mode to remove floating hair
Low battery	Welling up about 5 seconds every 30 minutes until the battery is exhausted	Flashing of red light (low battery warning)		<ul style="list-style-type: none"> • The product cannot be run in smart mode to remove floating hair • Low battery warning, please replace the battery in time • The pump stops working when the battery is about to run out

The battery can be used for seven days when fully charged.

Maintenance and Cleaning

Cleaning and maintenance of water storage barrel

- Do not expose it in the sun, so as not to accelerate the yellowing of the machine.
- Please clean the complete device after disconnecting the power supply, and please ensure that the bottom connector is dry.
- Please clean the inner barrel in a large-capacity container such as a sink to prevent water from spilling.
- DO NOT use petrol, kerosene, polishing powder, bleach and other chemical reagents to clean the device.
- The bucket, drinking tray and filter tray can be rinse with water under 80°C if needed.
- For daily maintenance, wipe the surface of the device of power cord to remove stains with a soft cloth rinsed with warm water. (Please remove the power first)
- It is recommended to completely replace the drinking water for 3-4 days when replacing, please empty the fountain to remove hair and other sticky substances of the stainless-steel inner barrel and the CNC water pump of the Fountain and the filter.
- When not used for a long time, please clean the device, and put the parts into the packing box in the original packaging order after dry and store them properly in a dry place.

The replacement of filter element

1. The filter be replaced every 60 days or so in smart mode (SMART), and every 30 days or so in normal mode (NOSMAL). (Specific replacement shall be subject to the filter indicator light.)
2. Soak the new filter thoroughly (it's recommended to soak twice, five minutes each time) and rinse slightly before replacing.
3. For the health of pets, please replace the filter frequently according to the use of the filter.

Cleaning of the CNC silent pump

1. The CNC silent pump shall be cleaned every week to prevent dirt from clogging the waterway, resulting in abnormalities such as poor water quality and poor water discharge.
2. Please scan the QR code to watch the cleaning steps of the CNC silent pump.



Scan the QR code to watch the cleaning video

FAQ

Power base faults:

- Ingress of water into the power base: Please unplug the power supply and keep it flat and place it in a ventilated place for 12 hours (please be careful not to reverse the base to prevent ingress of water into the main board) If the device still does not work after installing into the fountain, please contact customer service for treatment.
- No response of power base after replacement: Please confirm whether the base is placed in a humid environment, check the battery spring piece of the base for corrosion and yellowing, etc. Please contact customer service in case of any phenomenon.
- A "click" abnormal sound of the device: It is the sound of physical switch when the device automatically detects the battery voltage, which is normal phenomena.

Indicator light faults:

- The indicator light does not light after power on: Please re-plug or replace the USB power cable with the original one. If it still does not light, please contact customer service.
- The battery indicator light still lights red after battery replacement: Make sure to replace the batteries with five fully charged batteries.
- Failure to reset filter indicator after filter replacement (the filter indicator is not off): Please first confirm that the smart/normal mode can be switched normally when clicking. Or long press for reset after power off and restart. If the filter indicator still can't be reset, please contact customer service.
- In battery mode, the water shortage indicator light is normally on, but it still indicates water shortage after refilling: It is a normal phenomena; the device will detect the water level and turn off the indicator only when the pump is working, and in order to maximize the battery life, the device will switch to sleep mode. In this mode, the detection of water level will be paused. The plug-in can also be restored and then the indicator light can go out.

Filter

- A little black powder floating in the water: A little of non-toxic and harmless coconut shell activated carbon used for a PETKIT filter will float out with the water flow, which is a normal phenomena. Please feel free to use.
- A "click" sound of the pump in use: Due to the circulation of water flow, the coconut shell activated carbon floating in the water may be absorbed by the pump. Please check and clean up in time.

Water out flow faults

No water outflow after switching to normal mode:

1. Please confirm whether the water shortage indicator is on. If the water is full in the barrel, and the water shortage indicator still lights up, it may be the reason of bad contact. Try to separate and reposition the upper and lower barrels or contact customer service personnel.
2. Remove the tray set and confirm whether the pump is working or not. If the pump is working properly, try to align the pump with the water outlet and reposition it after replacing the filter or cleaning the tray set.
3. The pump does not work. Clean the pump according to the pump cleaning video instructions (see the QR code of the manual for details, be sure to carry out in the power off state. If the problem cannot be solved after the above steps, please contact customer service.

The water outflow becomes small:

1. Check whether the outlet of the filter tray is aligned with the outlet of the bottom pump.
2. The water level may be low due to the small quantity of water in the water storage barrel. Please refill with water as appropriate.
3. Please check the filter first, water pipe or pump for blocking. Disassemble and clean them and then try again or contact customer service.

Start to overflow after use for a period of time:

After the filter is used too long, the dirty residue on the surface will affect the seepage effect of the filter. Please replace the filter in time. Or check whether there is dirt clogging in water pipes and pump and try again after cleaning.

No water outflow of the Drinking Fountain after switching to battery mode in case of power failure:

It is a normal phenomena; In battery mode, if it is in the sleep time of the device, the pump will not work for the time being. Short press the button and water will immediately flow out the device and recirculate.

Basic Parameters

Product Name	PETKIT EVERSWEET 3 Smart Pet Drinking Fountain
Product Model	P4102
Overall Size	195 x 195 x 155
Recommended pet types	Cats and small-sized dogs
Complete machine weight	1.43kg
Rated voltage	5VDC
Rated power	2W

Warranty Conditions

A new product purchased in the Alza.cz sales network is guaranteed for 2 years. If you need repair or other services during the warranty period, contact the product seller directly, you must provide the original proof of purchase with the date of purchase.

The following are considered to be a conflict with the warranty conditions, for which the claimed claim may not be recognized:

- Using the product for any purpose other than that for which the product is intended or failing to follow the instructions for maintenance, operation, and service of the product.
- Damage to the product by a natural disaster, the intervention of an unauthorized person or mechanically through the fault of the buyer (e.g., during transport, cleaning by inappropriate means, etc.).
- Natural wear and aging of consumables or components during use (such as batteries, etc.).
- Exposure to adverse external influences, such as sunlight and other radiation or electromagnetic fields, fluid intrusion, object intrusion, mains overvoltage, electrostatic discharge voltage (including lightning), faulty supply or input voltage and inappropriate polarity of this voltage, chemical processes such as used power supplies, etc.
- If anyone has made modifications, modifications, alterations to the design or adaptation to change or extend the functions of the product compared to the purchased design or use of non-original components.

EU Declaration of Conformity

This equipment is in compliance with the essential requirements and other relevant provisions of EU directives.



WEEE

This product must not be disposed of as normal household waste in accordance with the EU Directive on Waste Electrical and Electronic Equipment (WEEE - 2012/19 / EU). Instead, it shall be returned to the place of purchase or handed over to a public collection point for the recyclable waste. By ensuring this product is disposed of correctly, you will help prevent potential negative consequences for the environment and human health, which could otherwise be caused by inappropriate waste handling of this product. Contact your local authority or the nearest collection point for further details. Improper disposal of this type of waste may result in fines in accordance with national regulations.

