

# **PATHFINDER2 SERIES**

**PATHFINDER2: PT20U, PR20U**  
**PATHFINDER2 MINI: PT20U, PM20U**

EXPLORE MORE - ADVANCED GPS TRACKING & TRAINING

## **Owner's Manual**

Please read this manual thoroughly  
before operating the Dogtra PATHFINDER2 series.

# IMPORTANT SAFETY AND PRODUCT INFORMATION

## WARNING

**Please read all safety and product information below before using your Dogtra product. Failure to follow these safety instructions could result in injury to you, your dog and others, or it could result in damage to your Dogtra product or other property.**

## DOG SAFETY

### Proper Use

Dogtra products should be used to train, educate, monitor, or track dogs. Each dog may have a different tolerance for and reaction to Dogtra products. Closely observe your dog when determining the right level of stimulation, receiver fit, and other settings of your Dogtra product.

### Training Methods

Dogtra products may be used with a variety of training methods that provide clear and consistent messages to your dog.

### Fit and Wear

Proper fit and wear of your Dogtra product is important for the comfort of your dog as well as the functioning of your product. Dogtra receivers should fit comfortably and not too tightly, so that the receiver stays in place and does not move around your dog's neck. Do not leave a receiver on your dog for an extended time. Although each dog is different, Dogtra recommends that its receivers be used a maximum of 4 to 6 hours at any one time on your dog. A receiver that is used for overly long periods or that fits improperly may cause skin irritation or sores on your dog's neck. Regularly check the receiver's contact area on your dog's skin. If your dog exhibits skin irritation or sores, stop using the Dogtra product and consult with a veterinarian.

## UNAUTHORIZED USE

Dogtra products should be used only in a safe and responsible manner to train, educate, monitor, or track dogs. Dogtra products are not intended for use in any other manner; they are not intended for use with other animals or with humans; and they are not intended for use in unsafe situations or environments that could lead to death, injury, loss or damage.

## BATTERY

Your Dogtra product contains batteries. Do not attempt to replace the battery yourself. Contact Dogtra or your Dogtra retailer to replace your battery. Dispose of batteries as provided by your local regulations. Do not disassemble, crush, heat, or otherwise alter the battery as it may cause fire, explosion, injury and/or property damage.

## OWNER SAFETY

### Handling and Repair

Dogtra products can be damaged or malfunction if dropped, especially on hard surfaces, or otherwise improperly handled. Do not use a damaged or malfunctioning product as it may cause injury or property damage. If your product is damaged or malfunctions, contact Dogtra to obtain service before using the product.

### Electrical Product

Your Dogtra product contains electrical components and batteries. Do not use or keep your product near heat or flammable sources. Such use or storage may damage your product and/or cause fire, explosion, injury, or property damage.

### Charging

Only charge your Dogtra product with its accompanying Dogtra charger. Do not attempt to charge your product in any other manner or in temperatures less than 32°F (0°C) or over 113°F (45°C) as it may cause fire, explosion, injury, and/or property damage. If you notice damage to your product, its charger, or battery, obtain service from Dogtra before charging the product. Do not use more than one splitter cable with a single battery charger.

### Medical Device Interference

Dogtra products contain electrical and magnetic components that emit low level electromagnetic waves and radio frequencies. These electromagnetic waves or radio frequencies may interfere with pacemakers, defibrillators, or other medical devices. Consult your physician or medical device maker before using your medical device with a Dogtra product. If you think that your Dogtra product is interfering with your pacemaker, defibrillator, or other medical device, stop using the Dogtra product.

### Aggressive Dogs

Do not use Dogtra products with aggressive dogs as such dogs may react adversely and cause injury to people or other dogs. Seek the assistance of a dog-training specialist or veterinarian when dealing with aggressive dogs.

### Children

Dogtra products are not toys. Adult supervision and close attention are necessary when Dogtra products are used by or near children.

## CONTENTS

PACKAGE CONTENTS .....	6
MAIN FEATURES .....	7
OVERVIEW .....	8
UNDERSTANDING YOUR TRAINING SYSTEM	
1. BUTTON FUNCTION .....	13
2. LED INDICATOR .....	14
GETTING STARTED	
1. DOWNLOADING THE PATHFINDER2 APP .....	15
2. ONLINE WEB MANUAL .....	15
3. PAIRING YOUR DEVICE .....	16
4. KEY FEATURES OF PATHFINDER2 APP .....	18
OTHER FEATURES & DETAILS .....	36
DEVICE INFORMATION	
1. RECEIVER FITTING .....	37
2. FINDING THE RIGHT STIMULATION .....	38
3. MAXIMIZING THE DISTANCE .....	39
PRODUCT MAINTENANCE	
1. CHARGING THE PATHFINDER2 .....	40
2. REPLACING THE ANTENNA .....	41
3. CHANGING THE CONTACT POINT LENGTH .....	42
4. USING THE TEST LIGHT .....	43
5. ATTACHING THE BELT CLIP .....	43
BASIC MAINTENANCE .....	44
TROUBLESHOOTING GUIDE .....	45
FCC WARNING .....	46
WARRANTY AND REPAIR INFORMATION .....	47

## PACKAGE CONTENTS

### PATHFINDER2



PATHFINDER2 GPS Receiver (PR20U) & GPS Connector (PT20U)

### PATHFINDER2 MINI



PATHFINDER2 MINI GPS Receiver (PM20U) & GPS Connector (PT20U)



Owner's Manual



Battery Charger



Splitter Cable



Belt Clip



Test Light \*



Contact Point Extension Washer/Adjustment Tool \*



Non-Stimulation Contacts \*

\* Not included with PATHFINDER2 TRX/PATHFINDER2 MINI TRX

## MAIN FEATURES



2-Second GPS Update Rate



Offline Maps



9-Mile Range



LED Locate Light



Expandable to 21 Dogs



3.5-Hour Rapid Charge Batteries



IPX9K Waterproof Certified



Belt Clip



Sleep Mode



E-Fence\*, Geo-Fence, Mobile-Fence



Enhanced Contact Points\*



Audible Tone\*



Nick/Constant Stimulation\*



Low-High Output in 1-100 Stimulation Levels\*



Tracking Only Mode\*



Pager Vibration\*

### PATHFINDER2 MINI



22% Smaller Than PATHFINDER2



4-Mile Range

For PATHFINDER2 TRX/PATHFINDER2 MINI TRX Only **UKC, AKC, and PKC Events Approved**

# OVERVIEW

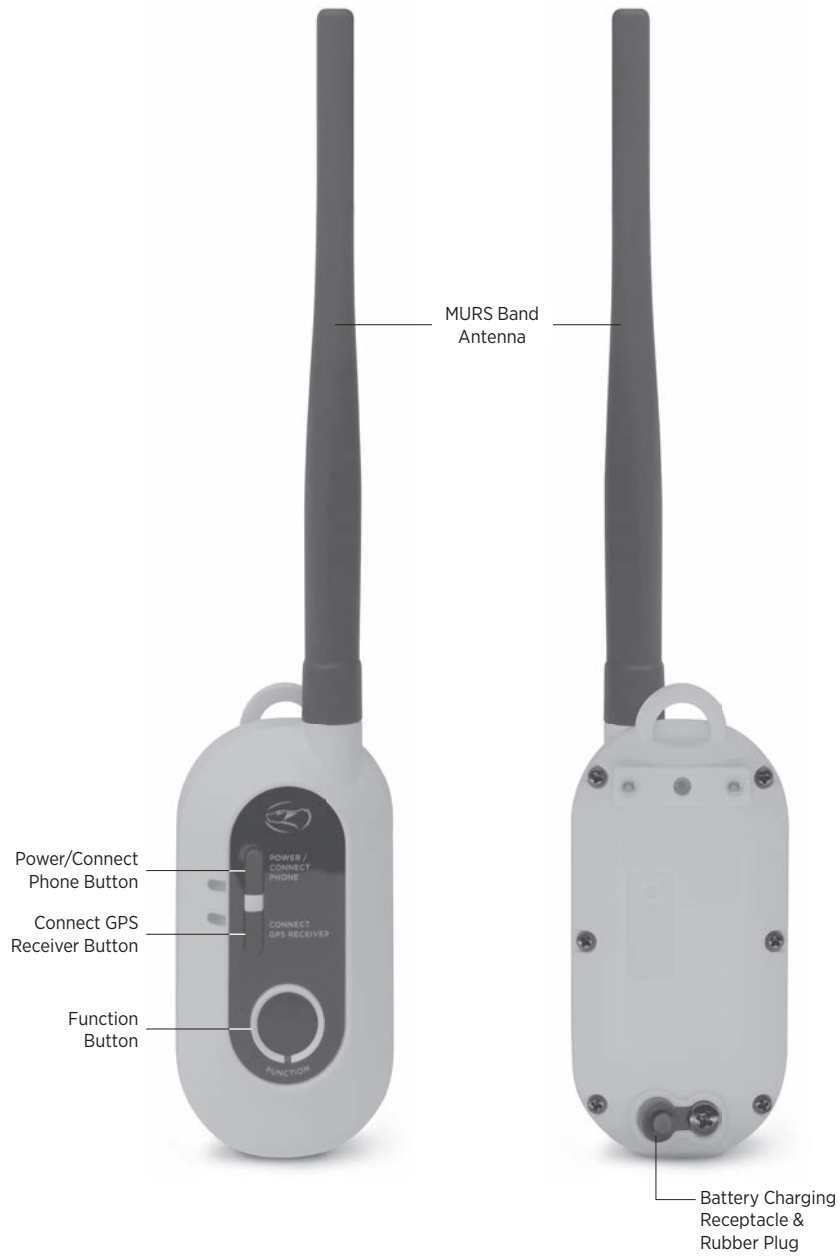

**PATHFINDER2**  
GPS Connector (PT20U)

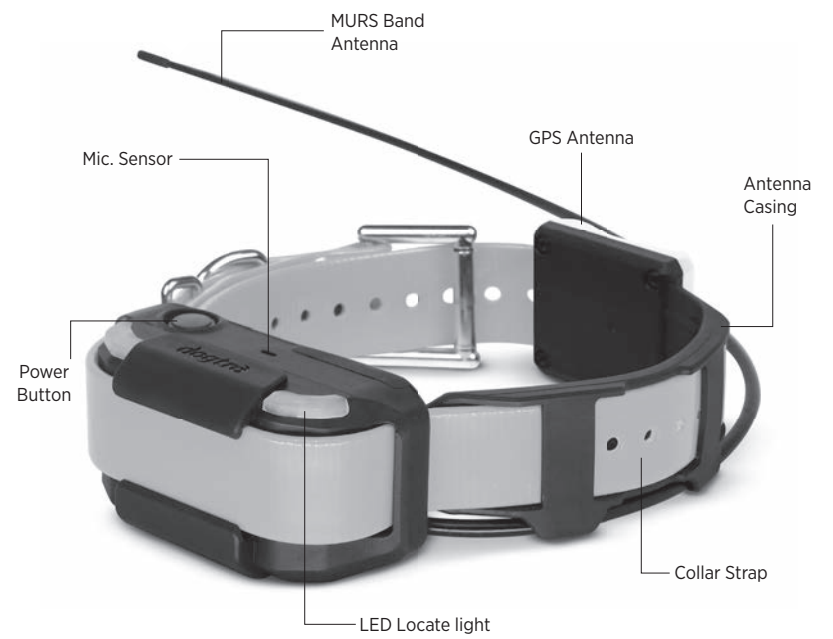
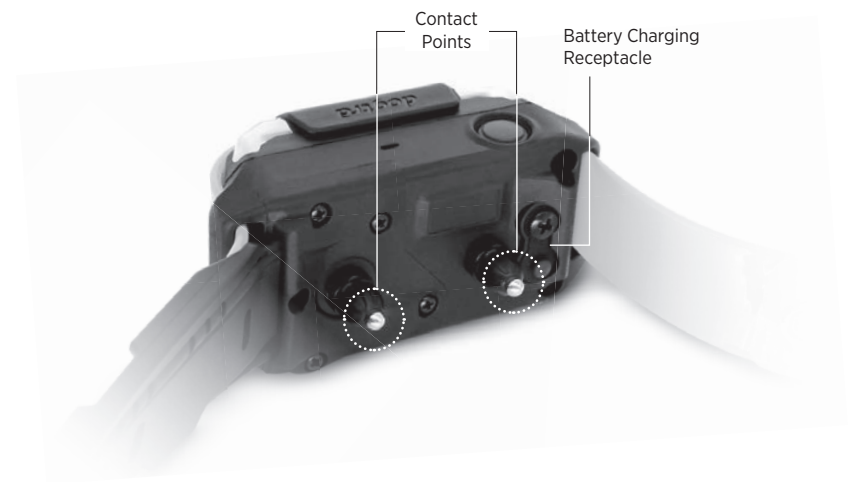

**PATHFINDER2**  
GPS Receiver (PR20U)

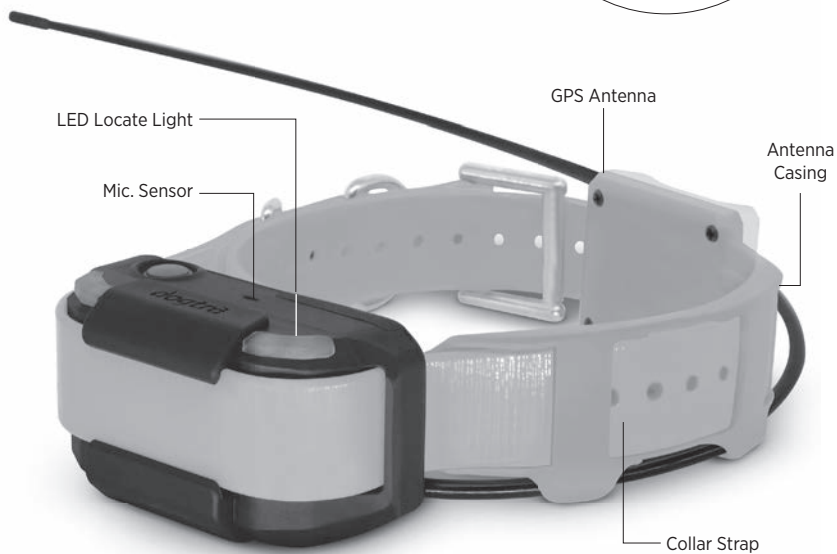
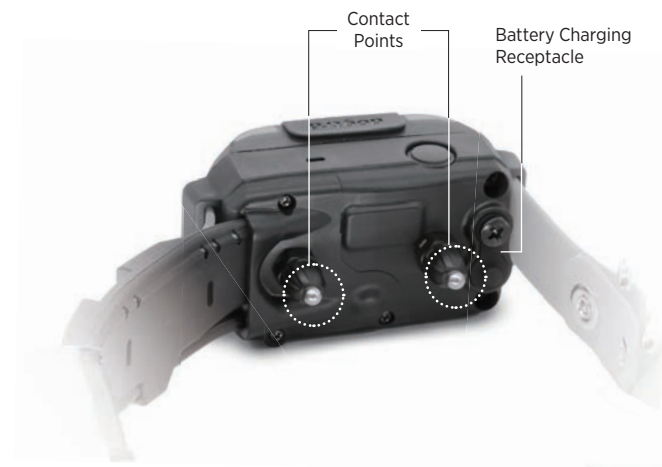

**PATHFINDER2 TRX**  
GPS-Only Receiver (PR20U)

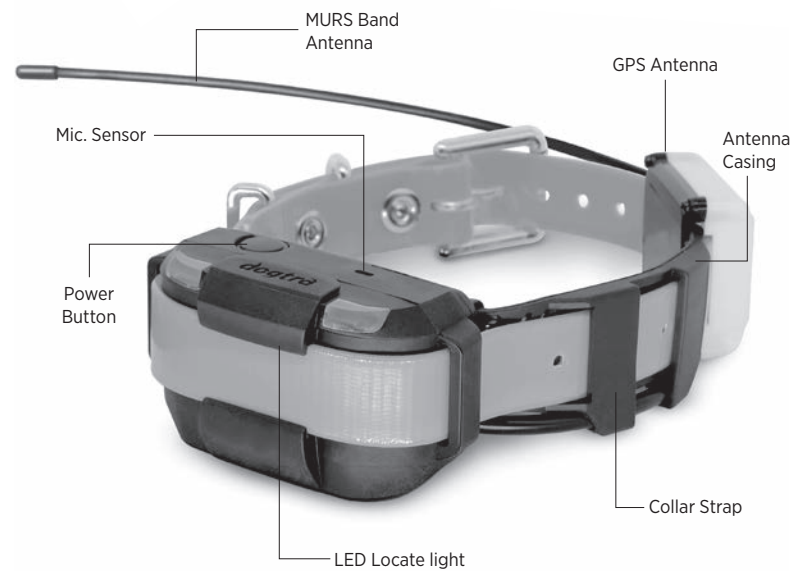

**PATHFINDER2 MINI**  
GPS Receiver (PM20U)



Battery Charging Receptacle

The PATHFINDER2 MINI TRX does not have contact points and does not come with stimulation, vibration, or tone.

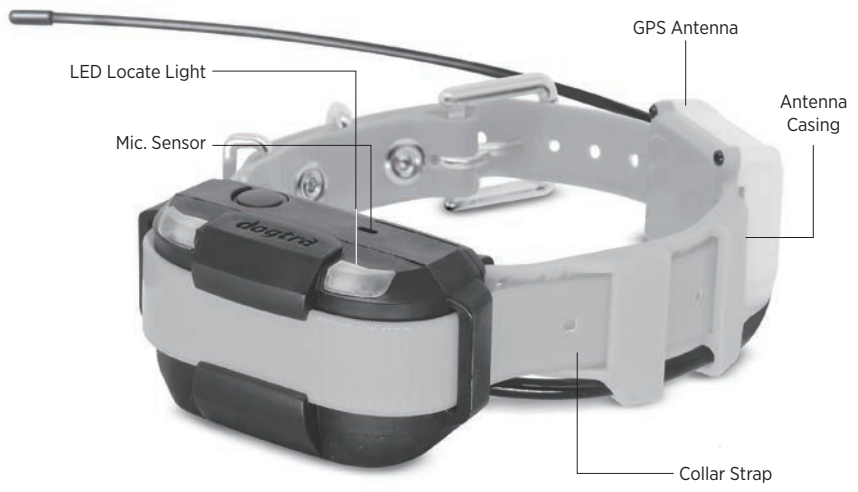

LED Locate Light  
 Mic. Sensor  
 GPS Antenna  
 Antenna Casing  
 Collar Strap

**PATHFINDER2 MINI TRX  
 GPS-Only Receiver (PM20U)**

# UNDERSTANDING YOUR TRAINING SYSTEM

## 1. BUTTON FUNCTION

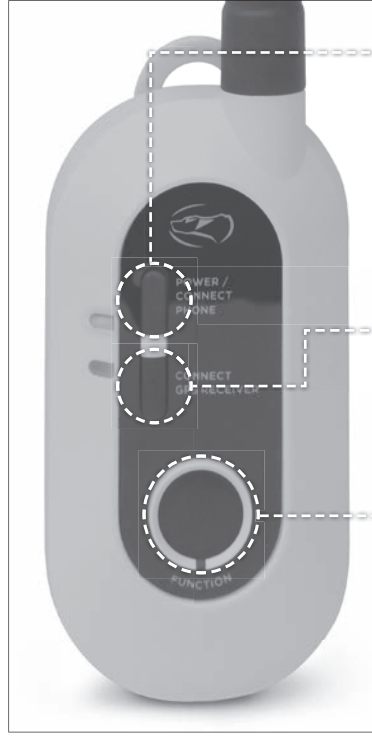

**GPS Connector (PT20U)  
 POWER/CONNECT PHONE BUTTON**

- On: Press the button until a green LED light appears and 3 short beeps emit.
- Off: Press the button until a red LED light appears and 1 long beep emits.
- Use this button to pair a smartphone. Find out more on page 16.

**CONNECT GPS RECEIVER BUTTON**

Use this button to pair a GPS receiver. Find out more on page 17.

**FUNCTION BUTTON**

The Function button will emit the e-collar function selected in the app when pressed. Find out more on page 24.



**GPS Receiver (PR20U, PM20U)  
 POWER BUTTON**

- On: Press the button until a green LED light appears and 3 short beeps emit.
- Off: Press the button until a red LED light appears and 1 long beep emits.



## 2. LED INDICATOR



### GPS Connector (PT20U)

The Power LED blinks every 2 seconds while turned on. The LED colors represent the battery life:

**Green: 50-100%**

**Orange: 10-49%**

**Red: 0-9%**



### GPS Receiver (PR20U, PM20U)

The LED on the GPS receiver blinks every 2 seconds while turned on. The LED colors represent the battery life:

**Green: 50-100%**

**Orange: 10-49%**

**Red: 0-9%**

The LED on the GPS Receiver will show different color when E-Fence or Locate Light function is activated.

When the E-Fence mode is on, the LED will blink in blue in between the battery life indication blinking.

When the Locate Light is on, the white LED will blink rapidly every 0.2 seconds without the battery life indication blinking.

## GETTING STARTED

### 1. DOWNLOADING THE PATHFINDER2 APP

#### To download the app:

- 1) Go to the Apple app store or Google play store on your device.
- 2) Search for "Dogtra PATHFINDER2" app.
- 3) Download the app on your device.



**Note:** Make sure to download the Dogtra PATHFINDER2 app as the previous app version is not compatible.

#### The app is currently compatible with:

- 1) Bluetooth 5.0 and above. Check the version with the phone manufacturer.
- 2) iOS: 12.1 and above, iPhone 8 and above
- 3) Apple Watch Series 5 and above
- 4) Android: 6.0 and above

Compatibilities are subject to change.



### 2. ONLINE WEB MANUAL



Use the QR code to check out the full version of the PATHFINDER2 manual and more. For more information, please check [www.DogtraPATHFINDER.com](http://www.DogtraPATHFINDER.com).

\*PATHFINDER2 app and screenshot images are subject to change as Dogtra continues to update the software



### 3. PAIRING YOUR DEVICE

The PATHFINDER2 GPS connector connects a smartphone and receiver. These devices need to be paired for the system to work properly.

#### PAIRING THE GPS CONNECTOR TO A PHONE



1 Make sure the PATHFINDER2 app has been downloaded on your phone. Turn on Bluetooth on your phone and place the GPS connector next to your phone.

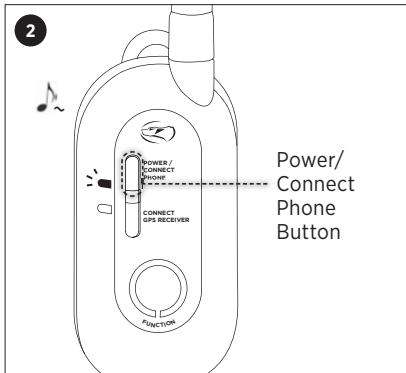

2 Make sure the GPS connector is off. Press and hold the Power/Connect Phone Button until a green LED light flashes and a melody plays to search for your phone.

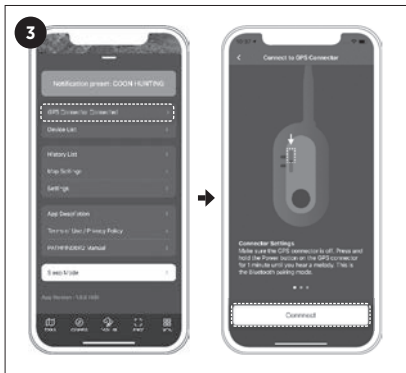

3 In the app, go to the Menu tab and click on 'Connection Failed with GPS Connector.' Press the 'Connect' button once the pairing screen shows on the app.

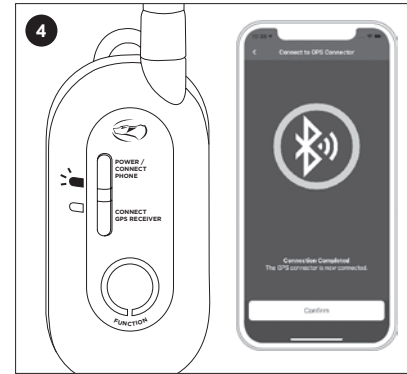

Your phone should show a connection completion screen and the green LED will blink slowly on your GPS connector.

#### PAIRING THE RECEIVER TO THE GPS CONNECTOR

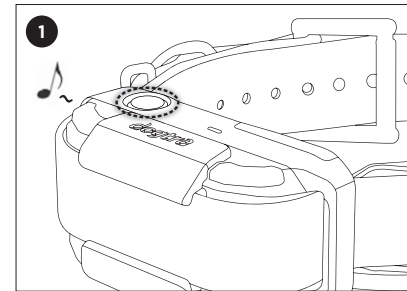

1 Make sure the receiver is turned off. Press and hold the power button for more than 3 seconds until the green LED rapidly flashes and a melody plays. Release the button.

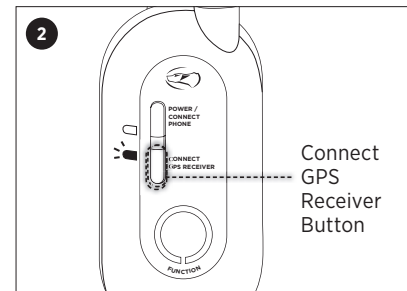

2 Make sure the connector is turned on. Press and hold the Connect GPS Receiver Button until the green LED rapidly flashes.

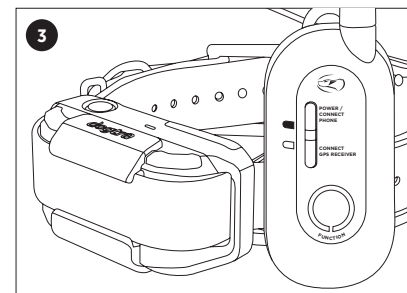

The pairing is complete when the melody stops and the LED lights stop rapidly flashing.

## 4. KEY FEATURES OF PATHFINDER2 APP

### 4-1. MAP

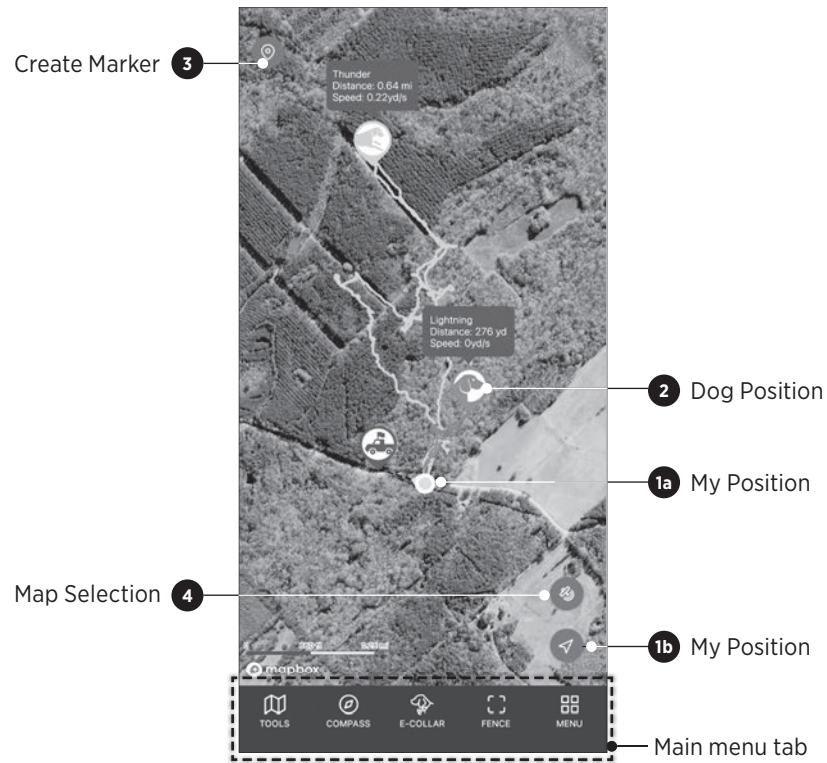

Icon	Description
	<b>1 My Position</b> <b>1a:</b> The Blue dot will show your location on the map. <b>1b:</b> Press the My Position button on the bottom right corner to re-center your location on the map and toggle map orientation.
	<b>2 Dog Position</b> The dog icon shows your dog's current action status. It also provides Traveled Distance, Current Speed, Altitude, Battery, Updated Time, and Shared Device.
	<b>3 Create Marker</b> Press the icon to add a marker. You can create markers for 'My Truck' (car location), Truck, Dog, Tree, Favorite, or Note.
	<b>4 Map Selection</b> Select general, satellite, or terrain map.

### 1) Map Features

#### Zoom

- Zoom in once: double tap the map with one finger.
- Zoom out once: single tap the map with two fingers.
- Use two fingers to pinch screen to zoom in and stretch the screen to zoom out.

#### Scroll

- You can scroll by using one finger to drag the map to the area you want to view.

#### Tilt

- Tilt the map by using two fingers and dragging the map up or down.

#### Rotate

- Rotate the map by using two fingers and applying a turning motion.

### 2) Dog Icons

Icon	Description
	<b>Default Status:</b> No motion detected.
	<b>Bark:</b> When the dog is barking.
	<b>Pointing:</b> When the dog is not moving and pointing towards game.
	<b>Treeing:</b> When the dog has two paws up on the tree to force animals up the tree.
	<b>Running:</b> When the dog is moving quickly.
	<b>Hog:</b> When multiple dogs bark within 20 meters of the receiver.
	<b>PATHFINDER TRX Receiver:</b> Receiver cannot use e-collar functions.

Icon	Description
	<b>No GPS:</b> Receiver cannot connect to GPS and cannot send location.
	<b>No RF:</b> Devices are far apart. Move the GPS connector to a higher area to receive signal.
	<b>Recharge Battery:</b> Less than 20% battery life remains.
	<b>Share:</b> Appears when another user's devices are shared. Cannot use e-collar functions on shared devices.
	<b>E-Fence On:</b> Receiver has been synced with the E-Fence.

#### 4-2. TOOLS TAB

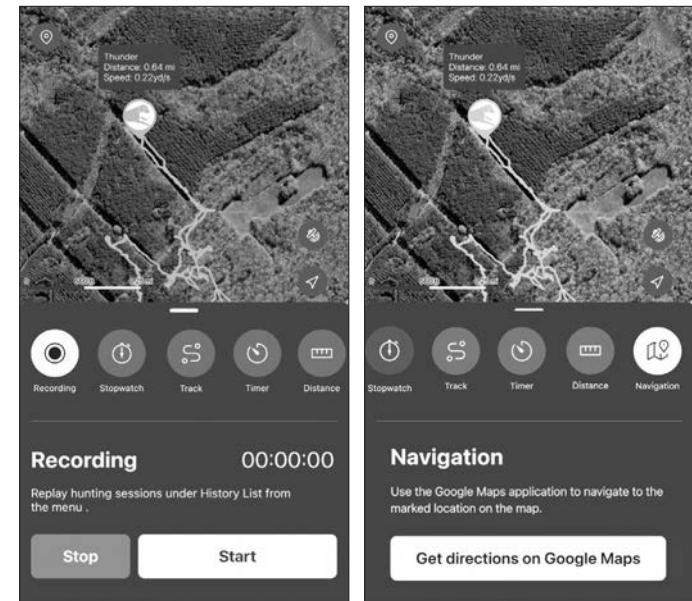

Icon	Description
	<b>Recording:</b> Record sessions for location and statuses. Replay sessions from the History List on the menu.
	<b>Stopwatch:</b> Measure the amount of time that has elapsed, which will be visible on the map.
	<b>Track:</b> View track lines on the map for past 5 hours and reset any track information.
	<b>Timer:</b> Set a timer that will alarm at the end of a time interval, which will be visible on the map.
	<b>Distance:</b> Measure the distance between two points on the map.
	<b>Navigation:</b> Use Google Maps to navigate to the marked location. Google Maps must be installed.

### 4-3. COMPASS TAB



#### The Compass tab allows you to:

- View the direction and distance of dogs, selected marker, or hunter at a glance by swiping the bottom slider up.
- See each marker by swiping the slider left or right on the smallest slider size.
- Add 'My Truck' marker to view distance and direction.
- Use the 'View All' button to view all dogs and hunters at once. Dogs and hunters are not displayed when hidden or offline.

#### Notes:

- Metal phone cases or metal objects attached to the phone will interfere with the compass.
- The phone may need to be calibrated for the compass to work properly.

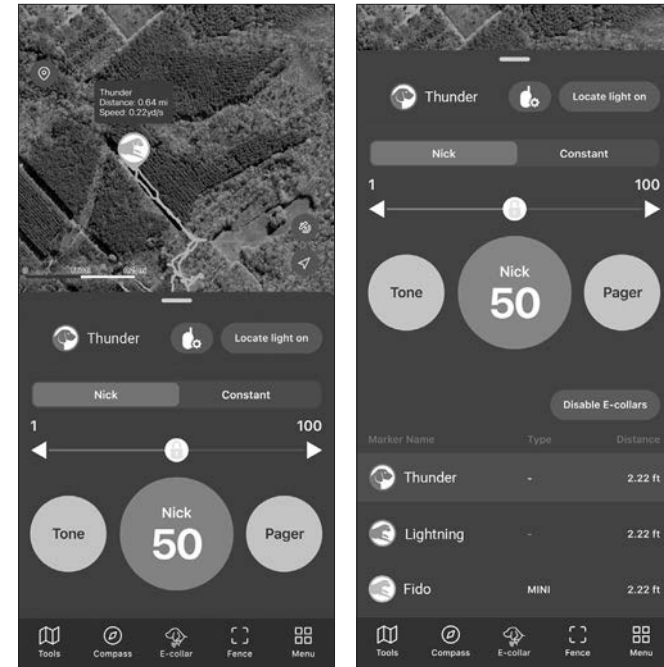

### 4-4. E-COLLAR TAB



#### Nick/Constant

Nick will emit a single rapid pulse of stimulation. Constant will provide continuous stimulation as long as the button is pressed, up to 12 seconds.

#### Stimulation Level

Set the stimulation from level 1-100 using the slider. Press and hold the button on the slider to turn the Lock feature on or off.  → 

#### Pager

Press Pager to emit the Pager as long as the button is pressed, up to 12 seconds.

#### Tone

Press Tone to emit a sound as long as the button is pressed, up to 12 seconds.

#### Locate Light

Press the Locate Light button to turn the light on or off.

#### Disable E-Collars

Pressing the 'Disable E-Collars' button will disable the e-collar function on all GPS Receivers and Connector to prevent accidental stimulation until re-activated. Press the same button again to activate the e-collar function. Slide the top edge of the E-Collar tab window upward to find the Disable E-Collar button under the stimulation buttons.

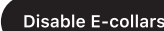
 : Disable E-Collar Button

## Sending Commands

1. Select the device from map or list view.
2. Select Nick or Constant and set the stimulation level from 1 to 100, which can be set for each dog.
3. You can also send commands such as Light, Tone, or Pager.

## GPS Connector's Function Button

The last used e-collar command will be color selected in the app. The Function Button on the GPS connector will operate the last selected command. Keep in mind that if the Lock is on in the app, the GPS connector Function button will be locked too.

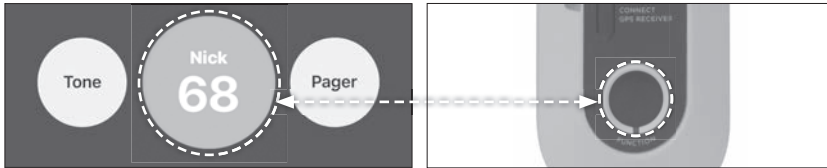

### Notes:

The E-Collar tab is disabled when the Tracking Only Mode is turned on in the Settings menu. Dogs are not displayed when hidden or offline. The PATHFINDER2 TRX receivers and shared receivers will not show on List view.

## Setting for the GPS Connector's Function Button

Press the 'Function Button Setting' icon on the E-Collar tab to arrange the stimulation type through the GPS Connector's Function button. This setting page is ideal when you want to change the stimulation type and level without commanding the GPS Receiver.



: Function Button Setting

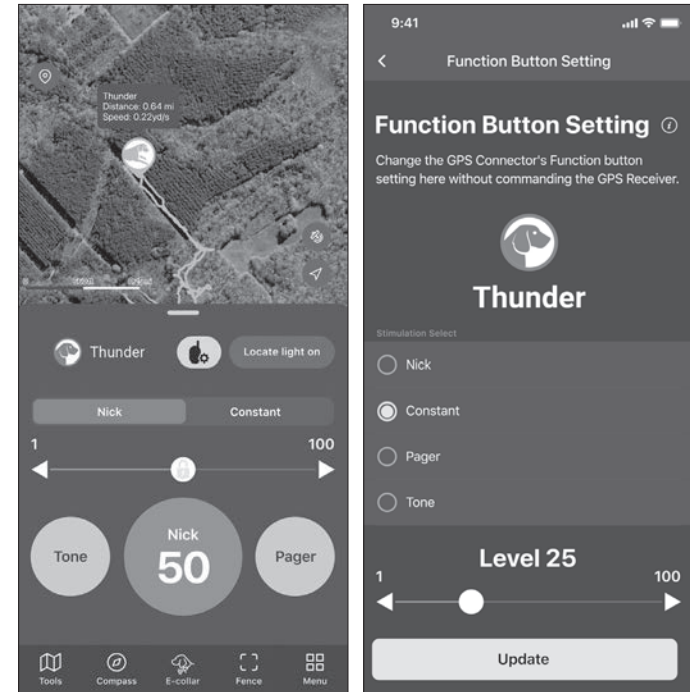

### Notes:

The arranged stimulation type and/or level from this page will apply to both on the app and GPS Connector. You cannot have two different stimulation types arranged for the PATHFINDER2 app and GPS Connector.



## 4-5. FENCE TAB

The PATHFINDER2 offers three types of fences for you to either receive a notification of your dog crossing boundaries or to auto-correct your dog.

The types of fences included are:

1. Mobile-Fence: A fence setup that moves based upon your smartphone location and will send you a notification.
2. Geo-Fence: A static fence setup that will send you a notification.
3. E-Fence: A static fence setup that will send your dog an auto-correction and send you a notification.

### 1) Mobile-Fence (Notification Only)

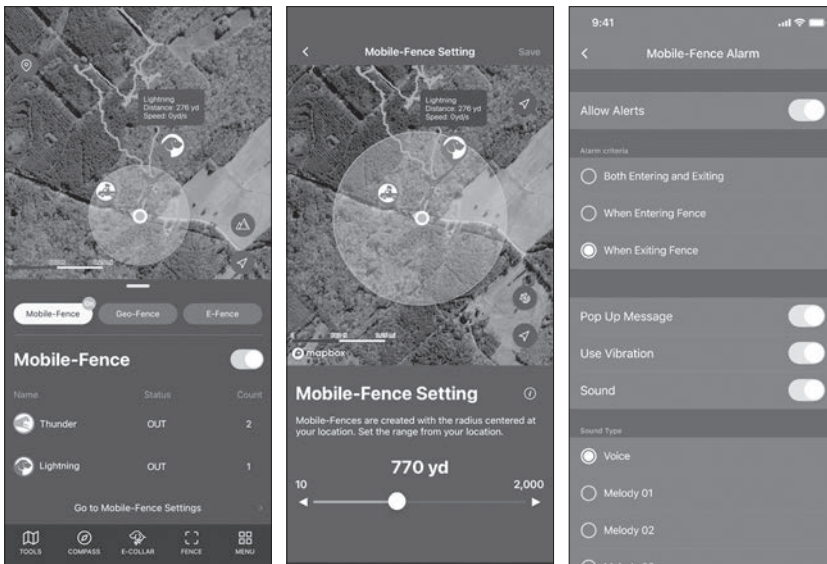

- Mobile-Fence is created with a radius centered around your smartphone (the blue point on the map).
- Status: Indication of receiver in or out of the fence.
- Count: Number of times the receiver has crossed the fence.
- Set the radius from 10 to 2,000 yards.
- Set the Mobile-Fence Alarm settings by going to MENU → SETTING → MOBILE-FENCE.

#### Notes:

- The Mobile-Fence gives a notification on the smartphone, but does not auto-correct the e-collar.
- The automatic e-collar correction will only work on the E-Fence.

### 2) Geo-Fence (Notification Only)

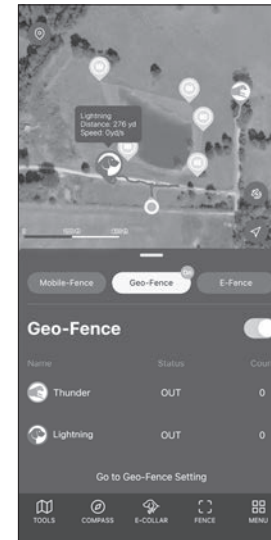

- Create Geo-Fences for specific areas to get alerts on your device.
- Status: Indication of receiver in or out of the fence.
- Count: Number of times the receiver has crossed the fence.
- Set the Geo-Fence Alarm Setting by going to MENU → SETTING → GEO-FENCE.

#### Notes:

- The Geo-Fence gives a notification on the smartphone, but does not auto-correct the e-collar.
- The automatic e-collar correction will only work on the E-Fence.



### Setting up a Geo-Fence

1. Press the + button.
2. Move the map and place the + on the desired area.
3. Click 'Drop Point' to create a point for the fence boundary.
4. Press Undo to delete the last point.
5. Click the save button on the top right.

- You can create up to 15 Drop Points and up to 15 Geo-Fences.
- Edit and delete file names and fence locations in the Fence List.

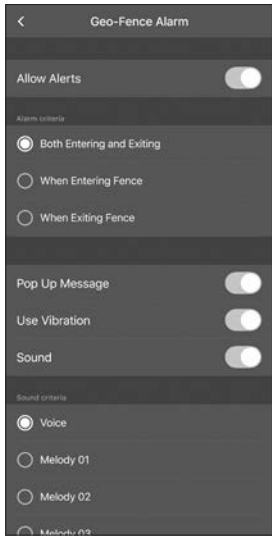

### Geo-Fence Alarm Setting

- You can create an alarm for both exiting and entering the Geo-Fence.
- You can select different alarm types.

### About the E-Fence

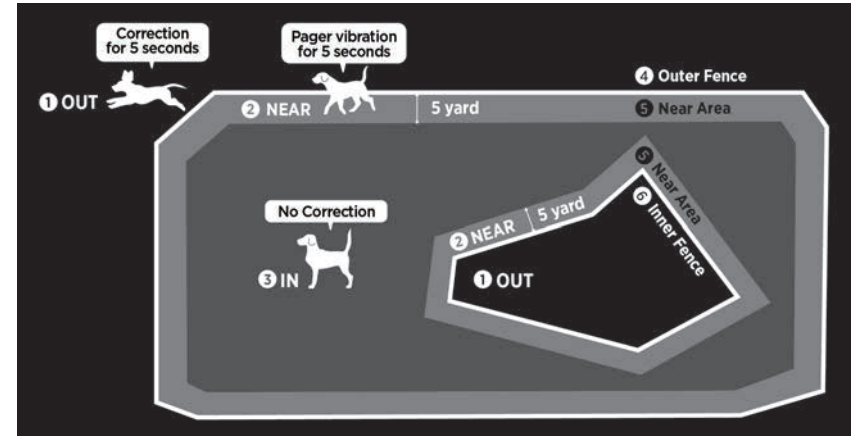

- 1 OUT:** When moving out of the boundaries, the e-collar emits Constant correction for 5 seconds.
- 2 NEAR:** The receiver emits a Pager vibration for 5 seconds when within 5 yards of the Outer Fence or Inner Fence.
- 3 IN:** Safe area with no correction.
- 4 Outer Fence:** One large fence on the outskirts.
- 5 Near Area:** Automatically created within 5 yards of the Inner and Outer Fence.
- 6 Inner Fence:** Up to 3 Inner Fences can be created within the Outer Fence.  
\*Inner Fences do not need to be created unless otherwise needed.

**Notes:** For the dog's safety, the stimulation will only last 5 seconds if the dog goes out of the boundaries. Make sure your dog comes back in the boundary after 5 seconds.

### Restrictions:

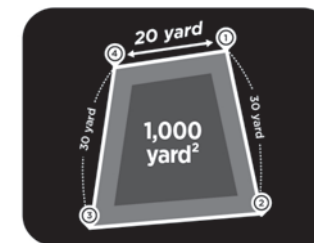

- Boundary design requires following:
- Minimum 1,000 yard<sup>2</sup> area (If adding the Inner Fence, need minimum 2,000 yard<sup>2</sup> area).
  - Minimum distance of 20 yard between each Drop Point.

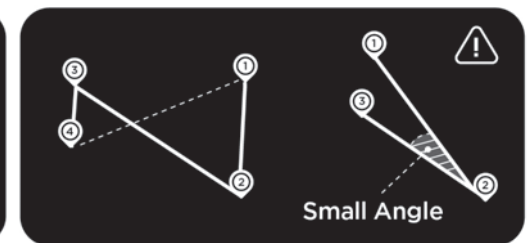

- The fence boundary design cannot cross over.
- The fence boundary design cannot have sharp pointed areas with small angles.



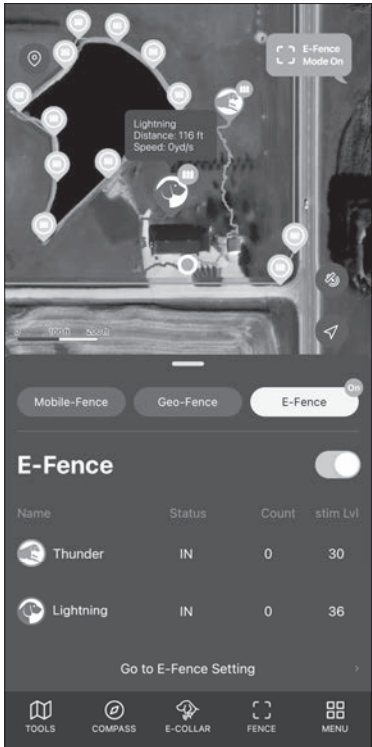

- ON/OFF: The E-Fence can be turned on/off by toggling the button. When turned on, the E-Fence Outer Fence shows up and a blue light on the receiver turns on.



: E-Fence On Mark

- Status: Current receiver status of IN, NEAR, or OUT. 'Need to update' will show up if you need to update the latest E-Fence boundary information.

- Count: The number of times the receiver crossed the boundary.

- Stim Lvl: Displays the correction level when activated. If it is not activated, it will show OFF and you will need to go to E-Fence Settings to activate the stimulation setting.

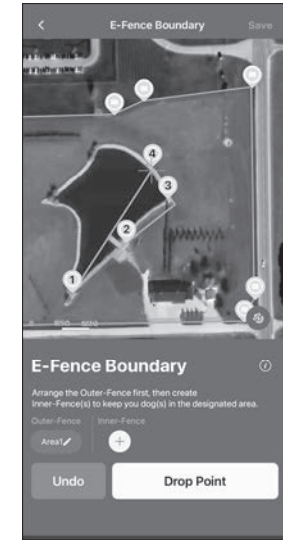
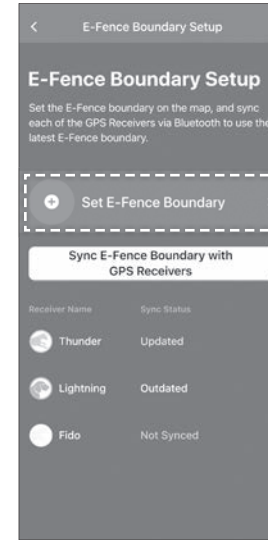

### Creating the E-Fence

Click on Set E-Fence Boundary.

### Setting up Outer Fence

- 1) Press the + button for the Outer Fence.
- 2) Move the map and place the + on the desired area.
- 3) Click 'Drop Point' to create a point for the fence boundary.
- 4) Repeat the process above to complete the boundary. Create the fence so it goes in one direction.
- 5) Click the save button on the top right. Only one can be saved.

### Setting up Inner Fence

- 1) The Outer Fence must be created first to create the Inner Fence.
- 2) Press the + button for the Inner-Fence.
- 3) Drag the area of the map you want to create the fence to the center with the +.
- 4) Click 'Drop Point' to create a point for the fence boundary.
- 5) Repeat the process above to complete the boundary. Create the fence so it goes in one direction.
- 6) Click the save button on the top right. Three can be saved.

- You can create 1 Outer-Fence and 3 Inner-Fences. All fences can use up to 15 points.

### Notes:

When the E-Fence feature is turned on, the receiver synced with the latest E-Fence boundary will have a blue LED. If there is no blue LED, sync the receiver to the boundary by referring to "Syncing E-Fence Boundary to the Receiver" on page 32.

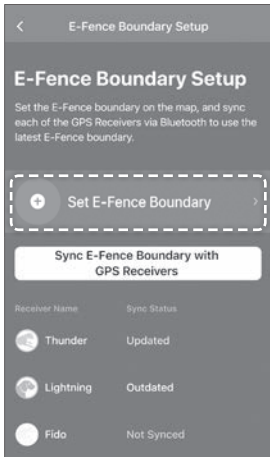

### Syncing E-Fence Boundary to the Receiver

In order to operate the E-Fence, the receiver must be synced.

- 1) Turn the receiver on near the smartphone.
- 2) Press the Sync E-Fence Boundary button.
- 3) Look at the list to make sure the receiver is synced.

#### Notes:

- After changing the E-Fence boundary, you must sync it again.
- Each receiver must be synced individually in order for the E-Fence to operate.

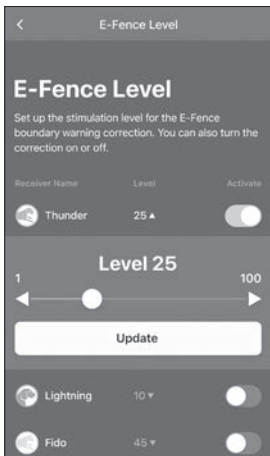

### Applying Stimulation on the Receiver

- 1) Press the ▼ button for the receiver on the menu.
- 2) Set the stimulation level.
- 3) Press update.

#### Notes:

- Go to E-Fence Settings to press the Activate button to turn the E-Fence operation on or off for each receiver.

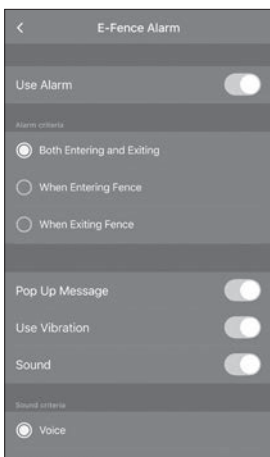

### E-Fence Alarm Setting

- Set the E-Fence Alarm Setting by going to MENU → SETTING → E-FENCE.
- You can create an alarm for both exiting and entering the E-Fence.
- You can select different alarm types.

## 4-6. MENU

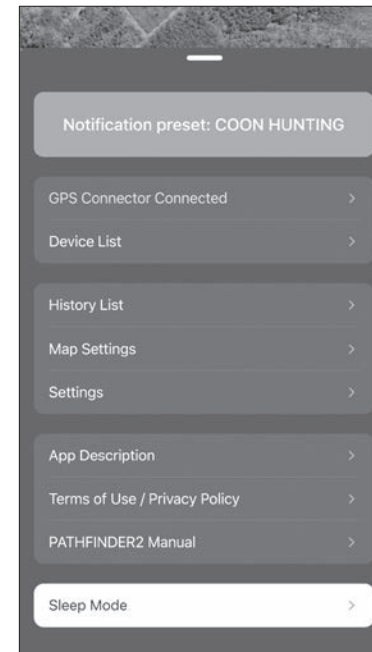

### Bluetooth Connection:

View the smartphone and GPS connector Bluetooth connection. If the devices are not paired, turn both the GPS connector and smartphone's Bluetooth off and then back on.

### Device List:

Find detailed device information and set individual settings.

### History List:

Play recorded history files. Convert files to GFX and KML files to share.

### Map Settings:

Manage Offline Maps and select the size and information of the marker.

### Settings:

Manage settings for different map features.

### App Description:

Describes basic contents.

1. Initial setup describes GPS connector and receiver pairing.
2. Main function will describe each tab.

### Terms of Use/Privacy Policy:

Check Terms of Use and Privacy Policy before use.

### Manual:

Quickly browse the manual.

### Sleep Mode:

Puts the receiver to sleep to preserve battery life. In sleep mode, the GPS signal for the receiver is turned off and will reset when turned back on.

#### 4-7. ACTIVITY MODE

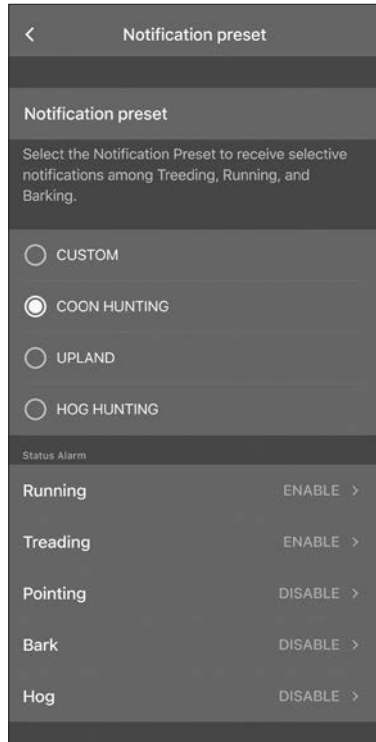

Activity mode: select the hunting type for your activity mode to change the settings to receive device status notifications.

Select the Activity Mode for Small Game, Upland, Hog Hunting, or Custom. The status alarm settings for Running, Treeding, Pointing, Bark, and Hog will change for each mode selected. You can select the alarm you want in Custom Mode.

#### 4-8. DEVICE ALERTS

- Select the device's alarms based on your specific needs.
- You can set each device's alarms by going to: Menu → Device List → Select Device → Alarm Setting.
- Refer to the table below for possible settings.

Category	Type of Alarm	Setting Up Alarm
Dog Status	Running, Treeing, Barking, Pointing, Hog Barking.	Menu → Setting → Activity Mode
Mobile-Fence	Exiting fence, entering fence, or both.	Menu → Setting → Mobile-Fence → Mobile-Fence Alarm
Geo-Fence	Exiting fence, entering fence, or both.	Menu → Setting → Geo-Fence → Geo-Fence Alarm
E-Fence	Exiting fence, entering fence, or both.	Menu → Setting → E-Fence → E-Fence Alarm
E-Collar	Using e-collar commands.	Automatic
Battery Life	20%, 15%, 10%, 5%	Automatic
Device Connection	RF connection with the receiver and if the receiver is working.	Automatic
Bluetooth Connection	Connect or disconnect status.	Automatic

# OTHER FEATURES & DETAILS



Use the QR code to check out the full version of the PATHFINDER2 manual and more. Go to [www.DogtraPATHFINDER.com](http://www.DogtraPATHFINDER.com) to see all the app features, such as:

- History Record, File, Detail
- Device List Options
- Device List Sharing & Receiving
- Map Management
- App Settings

\*PATHFINDER2 app and screenshot images are subject to change as Dogtra continues to update the software

## DEVICE INFORMATION

### 1. RECEIVER FITTING

#### Proper Fit

Fit the receiver on either side of the dog's windpipe so that the contact points press firmly against the dog's skin. You should be able to fit two fingers underneath the collar strap.

#### Improper Fit

A loose fit can allow the receiver to move around on the dog's neck and cause irritation. If the receiver is too loose, the contact will be inconsistent and cause inconsistent correction.

#### Attention!

While Dogtra uses medical grade stainless steel contact points and anti-microbial plastic to protect the dog's skin, leaving the receiver in the same location for an extended period of time can cause skin irritation due to the sensitivity from the contact points. Reposition the receiver every few hours to move the contact points and remove the receiver after 8 hours of use. Check for skin irritation each time you use the unit.

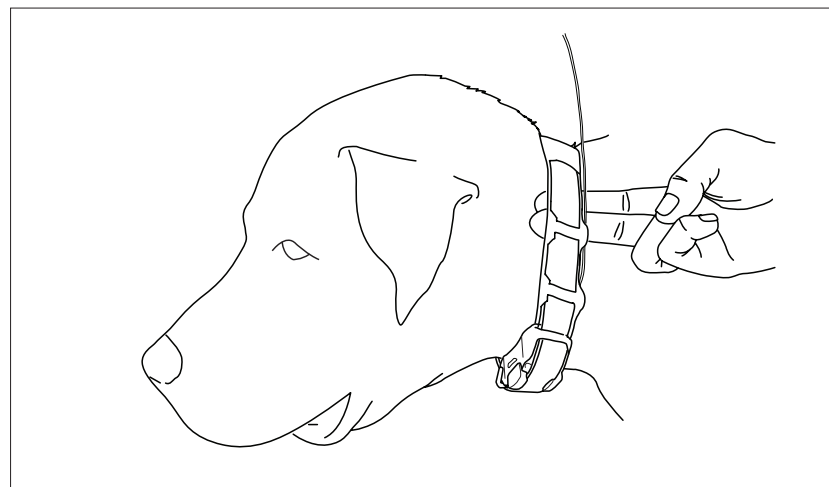

## 2. FINDING THE RIGHT STIMULATION

- Open the PATHFINDER2 app to the E-Collar tab and select your dog and stimulation level.
- The stimulation levels are from 1 (lowest) to 100 (highest).
- Always start at the lowest level of stimulation and work your way up.
- The appropriate level can be found when your dog responds to the stimulation with a mild reaction, such as a tensing of the neck muscles.

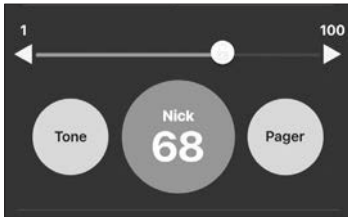

**Note:** Every dog has a different tolerance and reaction to the stimulation. Please look at your dog's reaction to find the right level of stimulation. The stimulation level may vary depending on the situation and distractions. A distracted dog will require a higher level of stimulation compared to when there is no distraction.

## 3. MAXIMIZING THE DISTANCE

- The line of sight range are following: PATHFINDER2 up to 9 miles, and PATHFINDER2 MINI up to 4-mile.
- To get the greatest range, hold the GPS connector away from your body and avoid touching the antenna.
- Keep your unit properly charged for maximum signal strength.
- The GPS connector device must be near your phone for proper operation, preferably less than 33 feet.

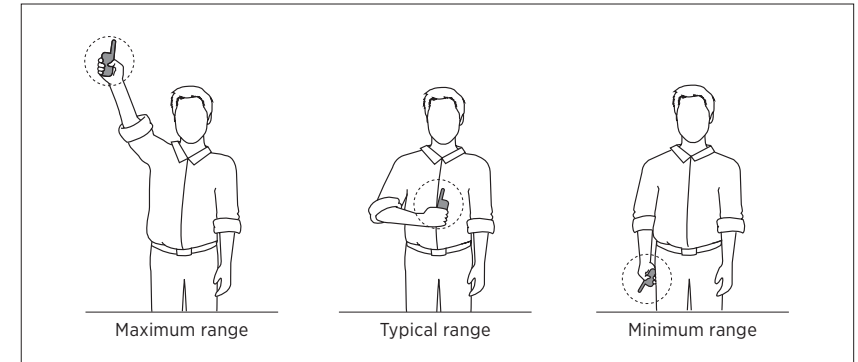

### Caution!

Operating the PATHFINDER2 near tall buildings and other steel structures will reduce the range of the GPS signal. Not acquiring a GPS signal for prolonged periods of time while outside may indicate issues with the unit.

# PRODUCT MAINTENANCE

## 1. CHARGING THE PATHFINDER2 SERIES

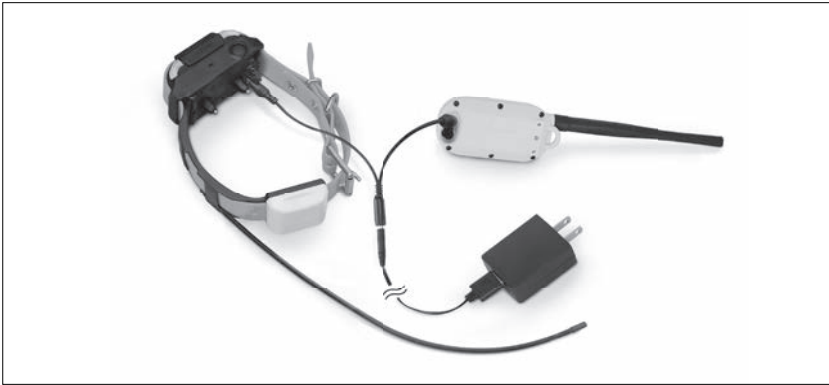

Fully charge the PATHFINDER2 series GPS Connector and Receiver before the first use. The PATHFINDER2 series uses lithium polymer batteries.

- Only use official Dogtra chargers with the PATHFINDER2 series devices.
- Do not charge the PATHFINDER2 series devices near flammable substances.
- Fully charge the PATHFINDER2 series devices if storing for 1 month or longer.

### When to Charge

- When the LED is red on the GPS connector or receiver.
- When the app displays low battery for the GPS connector or GPS receiver.
- When the LED on the transmitter or receiver will not turn on.

### How to Charge

1. Connect the charger to the GPS connector and receiver using the splitter cable.
2. Plug the charger into a 120-volt outlet.
3. When fully charged, detach the cables and plug the rubber caps over the charging ports on the GPS connector and receiver.
4. The LED will display red while charging and green when the unit is fully charged. A depleted battery requires 3.5 hours to fully charge.

### Splitter Cable

Do not use more than one splitter cable with a single battery charger.

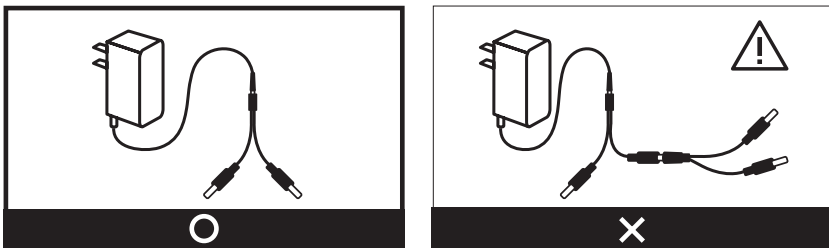

## 2. REPLACING THE ANTENNA

### For the GPS Connector

1. Twist the antenna counter-clockwise to remove.
2. Place the new antenna on the bolt and turn clockwise to tighten the antenna.

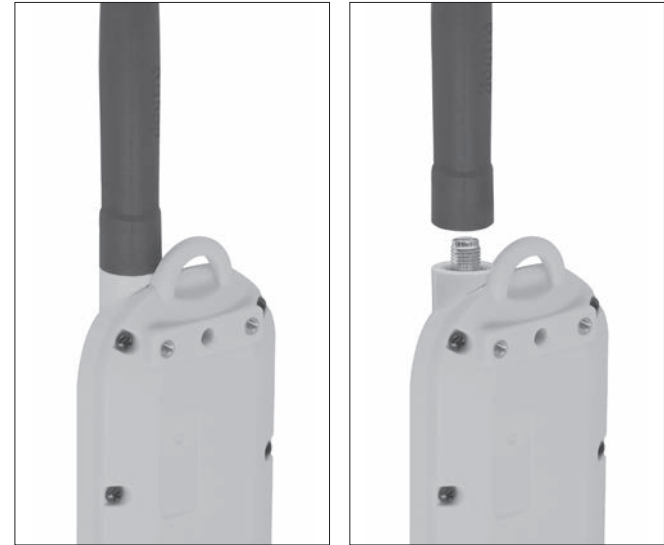

### For the Receiver



Open the antenna enclosure by removing the 5 screws and the contact points. Remove the screw holding the antenna in place to replace the antenna.

### 3. CHANGING THE CONTACT POINT LENGTH

The Dogtra PATHFINDER2 comes with 5/8" male contact points that can be extended to 3/4" for dogs with longer coats. (Excluding TRX series)

To increase the length:

- 1) Use the included adjustment tool side marked 5/8" to unscrew the contact points counter-clockwise.
- 2) Place the extension over the exposed threads, flat side down.
- 3) Place the contact points over the extensions and tighten clockwise using the adjustment tool side marked 3/4".

#### Caution!

Tighten until firmly in place. Be careful not to over tighten.

To shorten the length back to 5/8", use the adjustment tool marked 3/4" to remove the extensions and then tighten the contact points clockwise using the side marked 5/8".

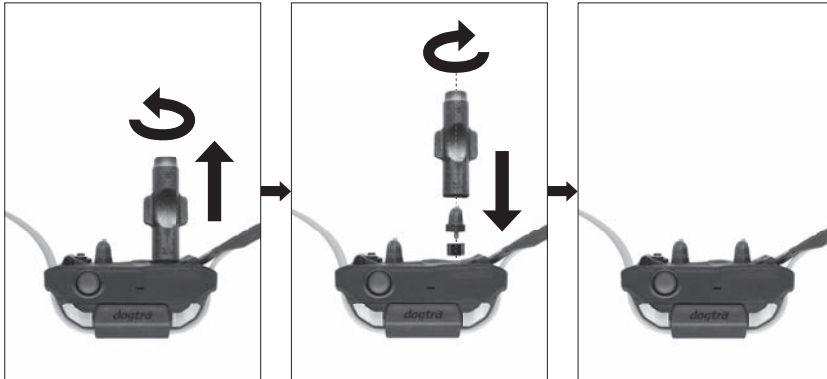

### 4. USING THE TEST LIGHT



- 1) Turn on the receiver and place the test light over the contact points.
- 2) Press the Nick button in the PATHFINDER2 app and the test light will light up momentarily.
- 3) Press the Constant button in the PATHFINDER2 app and the test light will light up as long as the button is pressed, for up to 12 seconds.
- 4) The test light will glow brighter at higher levels of stimulation and dimmer with lower levels.

**Note:** The test light may not be visible if the intensity level is set below level ten.

### 5. ATTACHING THE BELT CLIP

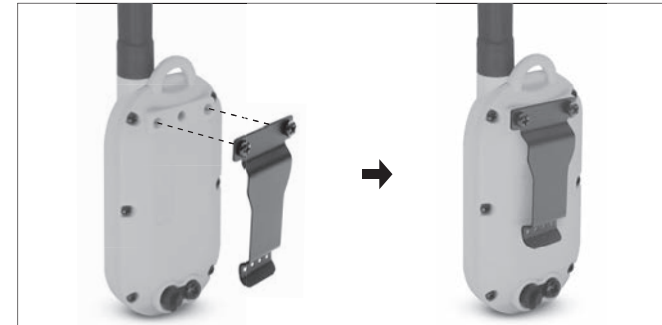

Follow the instructions below to attach the included belt clip to the GPS connector.

- 1) Align the belt clip to the grooves on the back of the GPS connector.
- 2) With a firm grip, screw on the belt clip's Phillips head screws with a screwdriver.

#### Caution!

Tighten until firmly in place. Be careful not to over tighten.



## BASIC MAINTENANCE

- Make sure the rubber charging cap is securely in place on the GPS connector or receiver when in use.
- Carefully inspect the unit for any missing parts or damage to the casing after use. Damaged or broken casing may affect the waterproof guarantee on the unit.
- The antenna must be securely in place for maximum range.
- Charge the unit for 3.5 hours before storing for extended periods.
- Charge the unit fully once a month while in storage or before use.
- Do not keep the unit exposed to extreme climates.
- Dogtra may include updates and improvements to the PATHFINDER2 app which can be downloaded through the App Store and Google Play.

## TROUBLESHOOTING GUIDE

### **1. The dog does not respond to the stimulation.**

- Make sure the system is on and the strap is tight enough so that both contact points are touching your dog's skin.
- If the contact points are too short, you can either purchase longer contact points or trim the hair near your dog's neck.
- Increase the level until your dog responds with a subtle head or neck movement.

### **2. The LED indicator light comes on, but I do not feel any stimulation.**

- Testing the system at various levels using the test light is the best way to test your system. Your tolerance may be higher than the level you are testing on yourself.
- The battery may be low. Check the LED indicator lights or the app for battery life.

### **3. The PATHFINDER2 has no range or the stimulation is weaker when my dog is farther away.**

- Keep objects away from touching the GPS connector's antenna as the range may decrease substantially.
- The range indicated is for line-of-sight flat terrain. Heavy brush, trees, hills, buildings, and/or moisture will affect the range of your unit. For the best range, hold the GPS connector vertically above your head, and/or try moving to higher ground.
- Any electrical conductors will affect the range, such as cars, chain-link dog runs, metal structures, and radio towers. For the best results, operate away from these structures.

### **4. The GPS connector or receiver is not holding a charge.**

- The charging pin may be damaged. A metal pin inside the charging port should stand straight up and firm in the center. If the pin is wobbly, broken or missing, you will need to send the unit in for repair.
- The charging port must be clean prior to charging, clean out any dirt with a cotton swab and some rubbing alcohol. If your dog was in salt-water, be sure to rinse the GPS receiver and charging port with clean water.
- For Dogtra units over two years old from the purchase date, the batteries may need to be replaced. You can replace them yourself by contacting Dogtra for a replacement battery. Damages incurred to the unit due to improper battery installations are not covered under the warranty. Dogtra strongly recommends sending the unit in for inspection and repair.

### **5. My dog has skin irritation.**

- This may be due to an improper fit or from wearing the receiver too long. If your dog exhibits signs of skin irritation, consult with a veterinarian. Once your dog's skin returns to a normal condition, continue to use the receiver and check your dog's neck each time you use the unit.

## FCC WARNING FOR PT20U/PR20U

The PATHFINDER2 complies with part 15 of the FCC Rules. Operation is subject to the following two conditions:

- (1) This device may not cause harmful interference, and
- (2) This device must accept any interference received, including interference that may cause undesired operation.

This is a sensitive radio device. Any unauthorized changes or modifications to this device that are not expressly approved by Dogtra will void the warranty and may void the user's authority to operate the equipment. Please do not tamper or modify the unit. Operation of MURS devices is not permitted on aircraft.

### Radio frequency Radiation Exposure for PT20U

Federal Communication Commission (FCC) Radiation Exposure Statement  
This equipment complies with FCC radiation exposure limits set forth for an uncontrolled environment. End users must follow the specific operating instructions for satisfying RF exposure compliance. This transmitter must not be co-located or operating in conjunction with any other antenna or transmitter. This equipment has been SAR-evaluated for use in hand. SAR measurements are based on a 5mm spacing from the body and that compliance is achieved at that distance.

### Radio frequency Radiation Exposure for PR20U/PM20U

To comply with FCC RF exposure compliance requirements, a separation distance of at least 24cm must be maintained between the antenna of this device and all persons. This device must not be co-located or operation in conjunction with any other antenna or transmitter.

Any changes or modifications (including the antenna) made to this device that are not expressly approved by the manufacturer may void the user's authority to operate the equipment.

## DOGTRA EXTENDED PRODUCT WARRANTY

### EXTENDED LIMITED WARRANTY

#### For Certain Dogtra Products Purchased from Dogtra Authorized Dealers

#### 1+1 Year Extended Warranty

Except as otherwise provided, Dogtra warrants to the original retail purchaser ("You") that your Dogtra product shall be free of defects in materials and workmanship for a period of one (1) year from the date of purchase ("Original Warranty"). As a special promotion, Dogtra further warrants that your Dogtra product shall be free of defects in materials and workmanship for an additional one (1) year from the date that your original warranty expires ("Extended Warranty"). The Original and Extended Warranties cover the cost of repair (parts and labor) or replacement (if repair is not feasible) of a defective Dogtra product during said warranty periods. For such repaired or replaced products, the remaining portion of the warranty periods, or ninety (90) days, whichever is longer, shall apply. Dogtra, at its sole discretion, shall determine whether to repair or replace a product covered by the Original Warranty or Extended Warranty.

#### Warranty Conditions

The Original and Extended Warranties are not transferrable and apply to your Dogtra product only if:

- (1) You are the original retail purchaser of the product,
- (2) You bought the product from a Dogtra Authorized Dealer, and
- (3) You present a receipt or other proof of purchase showing a valid purchase date, the name and address of the Dogtra Authorized Dealer, and the purchased product identified by model and/or serial number.

#### Warranty Exclusions

The Original and Extended Warranties do not cover damage, loss, or deterioration to your Dogtra product caused: by misuse, neglect, abuse, or other improper handling of the product; by failure to follow use or care instructions; by use of the product for other than its intended purpose; by accident or natural forces such as fire or flooding; or by normal wear and tear such as scratches to the product surface.

The Original and Extended Warranties also do not cover Dogtra products that: are purchased from non-authorized dealers; are purchased outside of the United States or Canada; have been damaged during shipment (even if Dogtra paid or arranged for shipping); have been modified or tampered with in any manner; are opened or repaired by anyone other than Dogtra; or have serial numbers that have been altered or defaced.



It has been tested and found to comply with RCM standards.

### **Sole Warranties**

The Original and Extended Warranties are the only warranties offered by Dogtra for your Dogtra product during said warranty periods. Other than the Original and Extended Warranties, Dogtra makes no other representations or warranties whatsoever regarding its products, whether oral or in any product manual, on any packaging, on any website, or in any other written material. No dealer of Dogtra products, nor any employee or agent of Dogtra, is authorized to make any additions, changes, or extensions to the Original Warranty or Extended Warranty. Dogtra, at its sole discretion and at any time, reserves the right to modify the Original and/or Extended Warranties.

### **DISCLAIMER OF OTHER WARRANTIES**

**THE FOREGOING ORIGINAL AND EXTENDED WARRANTIES ARE PROVIDED IN LIEU OF ALL OTHER WARRANTIES, WHETHER EXPRESS OR IMPLIED. DOGTRA DISCLAIMS ANY IMPLIED WARRANTIES INCLUDING, BUT NOT LIMITED TO, THE IMPLIED WARRANTIES OF MERCHANTABILITY AND FITNESS FOR A PARTICULAR PURPOSE.**

### **Limitation of Remedies**

Dogtra's liability is limited to the cost of repair or replacement of the Dogtra product under the Original Warranty or Extended Warranty. Any claim or action to enforce the Original and/or Extended Warranties must be commenced within thirty (30) days of such warranty's expiration for your product. Dogtra will not be liable for any indirect, incidental, special, consequential, or similar damages based on breach of warranty, breach of contract, negligence, strict tort, or any other legal theory related to Dogtra and its products. Damages that Dogtra will not be responsible for include, but are not limited to: loss of income or profits; loss of revenue or savings; loss of use of the product or associated products; cost of any substitute products or services; inconvenience, downtime, or any other time; loss of goodwill; claims of third parties including customers; and damage to property.

### **Legal Rights May Vary By State or Jurisdiction**

The Original and Extended Warranties give You specific legal rights, and You may also have other rights which vary by state or jurisdiction. Some states or jurisdictions do not allow certain limitations of implied warranties or of incidental or consequential damages or other remedies, so certain of the foregoing limitations may not apply to You.

If any portion of the Original Warranty or Extended Warranty is held by a court to be invalid or unenforceable, the remaining portions of such warranties shall remain in full force and effect and shall in no way be affected or invalidated, and the invalid or unenforceable portion shall be modified so as to most nearly achieve the intent of the Original Warranty or Extended Warranty.

### **Product Registration**

Dogtra recommends that customers register their products as soon as possible after purchase. Product registration will facilitate any future warranty service. You may also receive useful information and updates about your existing and future Dogtra products. To register your product, visit [\*\*www.dogtra.com/product-registration\*\*](http://www.dogtra.com/product-registration). If your product is not registered with Dogtra, You will be required to provide a receipt or other proof purchase (as provided above) to qualify for warranty service.

### **How to Obtain Warranty Service**

Should your Dogtra product require warranty service, please contact Customer Service by phone or email for a warranty evaluation (see below for contact information). Upon approval of your warranty work, Dogtra will repair or replace (at Dogtra's election) your product without charge for labor or parts. You are responsible for shipping, including cost, of your product to Dogtra for warranty service. Dogtra will handle shipping, including cost, of the repaired or replaced product back to customers in the USA. Dogtra will not be responsible for shipping, including cost and/or applicable taxes or fees, for products sent outside the USA. Such costs, taxes, or fees will be borne by the customer.

### **Dogtra Customer Service**

**12322 Monarch Street, Garden Grove, CA 92841**

(888) 811-9111

repair@dogtra.com

Mon – Fri, 8:00 AM to 4:30 PM (PST)

© 2022 Dogtra. All rights reserved.