

# ARC800 FREE PLUS

EXPANDABLE UP TO 2-DOG SYSTEM:  
ARC800 FREE PLUS ADDITIONAL RECEIVER

## Owner's Manual

Please read this manual thoroughly before operating the ARC800 FREE PLUS training e-collar.

# PRODUCT SAFETY AND HEALTH STATEMENT

## **Proper e-collar use**

Dogtra e-collars are intended for the sole purpose of behavior modification of dogs. They are NOT intended for human use or use on other animals. Dogtra-Europe does not assume any liability for the improper use of a Dogtra e-collar.

## **Aggressive dogs**

Dogtra highly recommends consulting a dog training professional when using an e-collar to correct dogs that are aggressive towards other dogs or people.

## **Interference with other electronic devices**

Dogtra's industry-leading technology filtering system ensures minimal interference with other electronic devices (garage door openers, mobile phones, etc.). Our digital microprocessor offers thousands of unique codes to eliminate frequency match-up with other Dogtra e-collars. Dogtra recommends consulting your physician if you are going to use the e-collar and you have any type of medical devices.

## **Inadvertent activation**

If the constant button is held down for 12 seconds or more, the unit will automatically shut down. It reactivates when the button is released and depressed again.

## **Proper Fit**

A loose fit can allow the receiver/collar to move around on the dog's neck. When this happens, the contact points may rub the skin and cause irritation. If the unit is too loose, the contact points will not make proper contact and your dog will not receive consistent stimulation.

## **Duration your dog can wear the unit**

Leaving the receiver/collar in the same location on the dog's neck for an extended period of time can cause skin irritation. If the dog is to wear the e-collar for long periods, occasionally reposition the receiver/collar so that the contact points are moved to a different location on the dog's neck. Make sure you check for skin irritation each time you use the unit. If your dog exhibits signs of skin irritation, consult with a veterinarian.

## **Reaction to the stimulation**

Every dog has a different tolerance and reaction to the stimulation. Please look at your dog's reaction to find just the right level of stimulation. The stimulation level may vary depending on the situation and distractions. Normally a distracted dog (chasing another dog, squirrel, etc.) will require a higher level of stimulation compared to when there is no distraction.

## **Training Methods**

E-collars can be used with many different methods. If you have any concerns in the training methods provided by Dogtra, consult with a dog training professional.

# CONTENTS

AT A GLANCE .....	53
MAIN FEATURES .....	54
OVERVIEW .....	55
UNDERSTANDING YOUR TRAINING SYSTEM	
1. TURNING THE SYSTEM ON/OFF .....	57
2. TRANSMITTER BUTTON FUNCTION .....	58
3. ARC800 FREE PLUS CODE SETTING .....	64
4. HANDSFREE SQUARE INFORMATION .....	66
5. RECEIVER FITTING .....	73
6. FINDING THE RIGHT STIMULATION .....	75
7. MAXIMIZING THE DISTANCE .....	76
8. LED INDICATOR .....	78
9. CHARGING THE BATTERY .....	79
10. HANDHELD TRANSMITTER LCD .....	83
11. ATTACHING THE BELT CLIP .....	85
12. USING THE TEST LIGHT .....	86
GENERAL TRAINING TIPS .....	88
MAINTENANCE .....	90
TROUBLESHOOTING GUIDE .....	91

# AT A GLANCE

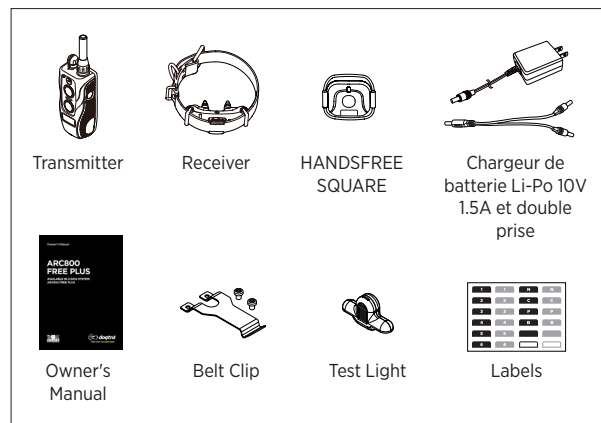

## Optional Accessories

### Auto Charger

The auto charger for the ARC800 FREE PLUS has an input of 12-volts to 24-volts and has an output of 10-volts 1500mAh.

### US Charger

Dogtra's US chargers are designed for use with a 110 volt AC electrical outlet.

To purchase accessories, please visit Dogtra's online store at [www.dogtra-europe.com](http://www.dogtra-europe.com) or call customer service at +33 (0)1 30 62 65 65.

## MAIN FEATURES

- HANDSFREE SQUARE for remote control
- Expandable up to 14 HANDSFREE SQUARES
- Expandable to a 2-dog system
- Maximum Range 800 metres
- IPX9K waterproof certified transmitter and receiver (HANDSFREE SQUARE is not waterproof)
- Medium output receiver
- 127-level stimulation with Rheostat Dial and LCD screen for precise control
- Safety Stimulation Level Lock
- Constant stimulation with customizable Boost button for instant level increase
- LCD screen display for stimulation level and battery life
- Nick/Constant stimulation & Pager vibration
- Enhanced contact points
- Ergonomic slim receiver design
- Checkered grip on handheld transmitter
- For dogs as small as 7 kg
- 2-hour rapid charge batteries for transmitter and receiver
- Replaceable lithium coin battery for HANDSFREE SQUARE

## OVERVIEW



**ARC800 FREE PLUS**  
**Transmitter**

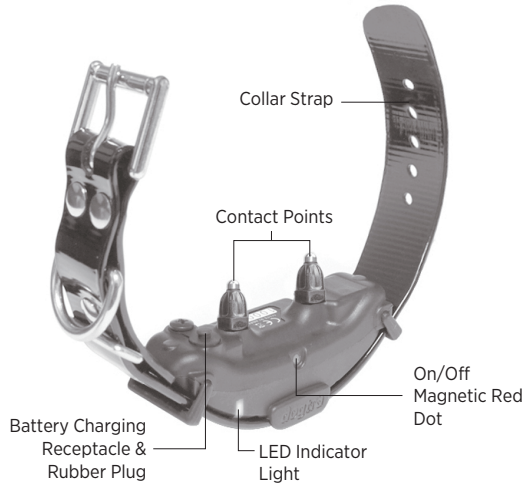

**ARC800 FREE PLUS**  
**Récepteur**



**ARC800 FREE PLUS**  
**Système mains-libres**

## UNDERSTANDING YOUR TRAINING SYSTEM

### 1. Turning the System On/Off

To turn the handheld transmitter on, hold down the button on the right side of the transmitter until the LCD screen illuminates. To turn the transmitter off, hold down the same button on the right side of the transmitter until the LCD screen shuts off.



To turn on the receiver, place the red dot on the back of the transmitter to the red dot on the receiver. Hold the two red dots together for a moment until the LED light on the receiver comes on.

To turn off the unit, repeat the same procedure holding the two red dots together momentarily. The LED light will turn red for a brief moment indicating that the receiver has now shut off.

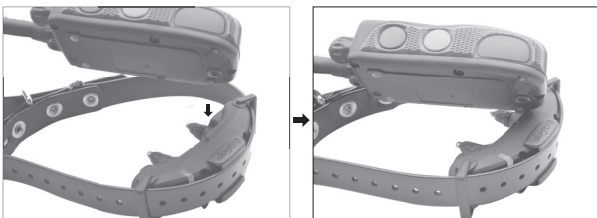

## 2. Transmitter Button Function

The ARC800 FREE PLUS has five buttons and a toggle switch on the transmitter (two on the face of the transmitter, two on the left side, and one on the right side). You can change the Receiver by pressing the toggle switch up and down. When you purchase the ARC800 FREE PLUS additional receiver to expand to a 2-dog system, you will need to pair the new receiver to the orange buttons before use.



### Nick Button

The Nick button is located on the top of the left side of the handheld transmitter. When the Nick button is pressed, the receiver emits a single rapid pulse of electrical stimulation.

### Constant Button

The Constant button is located on the bottom of the left side of the handheld transmitter. Pressing the Constant button gives continuous stimulation as long as the button is pressed for up to 12 seconds. If the button is not released after 12 seconds, the stimulation will automatically turn off as a safety feature. The receiver will be ready to be reactivated once the button has been released.

### Pager Button

The Pager button is located on the face of the transmitter. Pressing it will give a vibration for as long as the button is pressed, for up to 12 seconds.

### On/Off Button

To turn on ARC800 FREE PLUS, press and hold the right on/off button until the front LCD screen turns on. To turn off, press and hold the right on/off button until the LCD screen is turned off. The LCD light automatically dims after 4 seconds.

### Safety Level Lock/Unlock Button

To lock in a chosen stimulation level tap the On/Off button once you have selected your chosen level. The lock icon will appear on the LCD screen indicating the selected stimulation level is locked in place to prevent any level changes. To unlock the stimulation level tap the on/off button to release the stimulation lock.



Unlock LCD Screen



Lock LCD Screen

### Customizable Boosted Constant

Once the boost amount is set up, a boost icon appears on the LCD screen. If the Boosted Constant is not set up, it will operate as a Constant button at the displayed stimulation level.



Boosted Constant Off



Boosted Constant On

### Boosted Constant

The Boosted Constant feature will apply up to 12 seconds of continuous boosted stimulation at the preselected boosted level.

$$\text{Current level} + \text{Boost amount} = \text{Boosted Constant output}$$

### Example

If you set the Boost amount at 10, the Boosted Constant output will increase as shown below.

Current displayed level	Boost amount	Boosted Constant output
0	10	10
15	10	25
30	10	40
40	10	50

### Attention!

To use the Boosted Constant button at your current displayed level, simply set the Boost amount to zero.

## Setting up Boosted Constant feature



1. Set the stimulation level to zero.

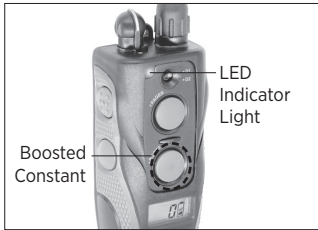

2. Hold the Boosted Constant button for 5 seconds until the LED light blinks; then release it.



3. Turn the Rheostat Dial to select the incremental Boost amount as shown on the LCD screen.

**Note:** Set the Boost level to 0 to use the Constant stimulation without Boost.



4. Tap the Boosted Constant button to save the setting.

**Note:** The saved setting will remain even if the unit is turned off. To reset the setting, repeat the steps above.



### 3. ARC800 FREE PLUS CODE SETTING

Follow the steps below to code an ARC800 FREE PLUS transmitter to a new or existing additional receiver.

Coding the transmitter and receiver:



1. Set 1D or 2D using the Toggle Switch on the transmitter and dial to set the stimulus level to '0'.

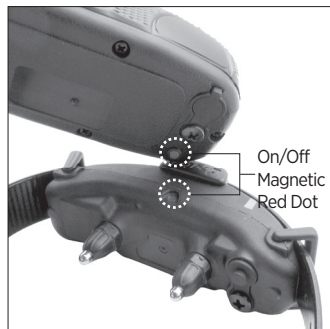

2. With the receiver turned off, place the red dot on the transmitter to the red dot on the receiver. Hold together until the green LED blinks rapidly on the receiver.

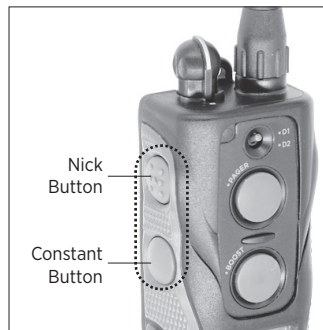

3. Pressing 'Nick Button' and 'Constant Button' on the transmitter when the receiver's LED is blinking



4. LED flashes every 4 seconds after the LED on the receiver is on, connection complete

#### 4. HANDSFREE SQUARE Information

The HANDSFREE SQUARE gives you the freedom to multitask and have discreet fingertip control. The function (Nick, Constant, or Pager) can be coded to the HANDSFREE SQUARE for you to operate remotely instead of having to carry the transmitter in your hand.

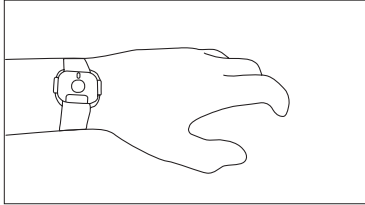

The HANDSFREE SQUARE has been tested and can be used in extreme conditions, between -20 °C to 60 °C.

**Note:** The HANDSFREE SQUARE can be used with previous versions of the HANDSFREE line. The previous HANDSFREE series can pair only one HANDSFREE SQUARE to one transmitter, while the HANDSFREE PLUS series can pair up to 14 HANDSFREE SQUARES to one transmitter.

#### Range

Depending on where the handheld transmitter is placed, your body can act as a barrier between the HANDSFREE SQUARE and the transmitter. The handheld transmitter's antenna should be kept in the open for maximum range. Placing the transmitter in the bottom of a bag or in a cargo pocket where the antenna is covered may reduce the range between the transmitter and the receiver. The HANDSFREE SQUARE will need to be within 10 metres of the transmitter to work.

#### Battery Life

The LED on the HANDSFREE SQUARE will blink when the button is pressed. Replace the battery in the HANDSFREE SQUARE when the LED no longer blinks. With normal usage (button held for 12 seconds, 100 times a day), the battery should last 7-10 years.

### Fastening the HANDSFREE SQUARE Strap

The HANDSFREE SQUARE strap can be fastened to your wrist, palm, or around a gun stock. Follow the fastening instructions below.

1. Wrap the strap around the object you are fastening the strap to. Pull the strap through the lower section of the buckle and use the notch to keep the HANDSFREE SQUARE securely in place.

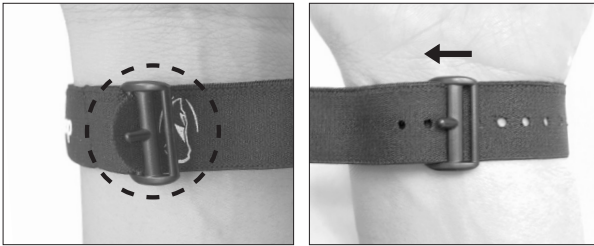

2. Loop the strap back through the top section of the buckle.

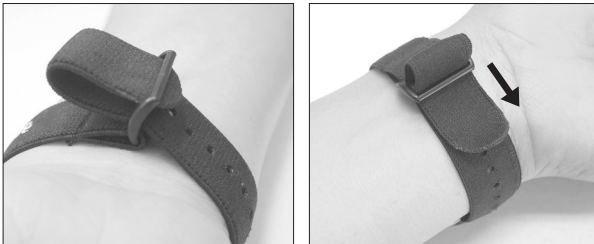

### Changing the HANDSFREE SQUARE Setting

The default setting for the HANDSFREE SQUARE is the Constant stimulation.

To change the setting or add more HANDSFREE SQUARES, proceed with the following steps:

1. Begin with the transmitter turned off.
2. On the handheld transmitter, hold down the following buttons to code the desired setting on the HANDSFREE SQUARE.

## ARC800 FREE PLUS - 1st Dog

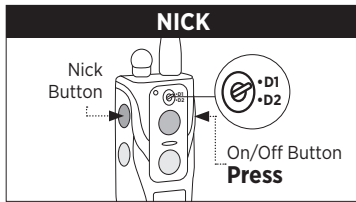

Move the toggle switch up for "D1."  
Hold down the on/off button and the Nick button.

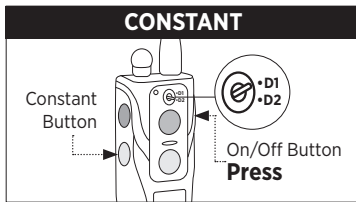

Move the toggle switch up for "D1."  
Hold down the on/off button and the Constant button.

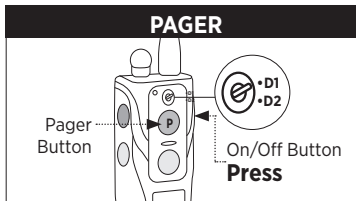

Move the toggle switch up for "D1."  
Hold down the on/off button and the gray Pager button.

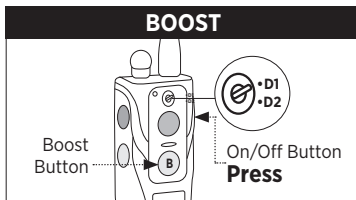

Move the toggle switch up for "D1."  
Hold down the on/off button and the brown boost button.

## ARC802 FREE PLUS - 2nd Dog

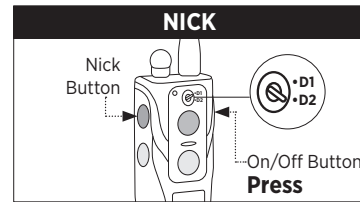

Move the toggle switch down for "D1."  
Hold down the on/off button and the Nick button.

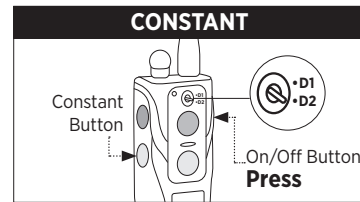

Move the toggle switch down for "D2."  
Hold down the on/off button and the Constant button.

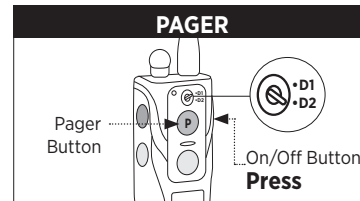

Move the toggle switch up for "D2."  
Hold down the on/off button and the gray Pager button.

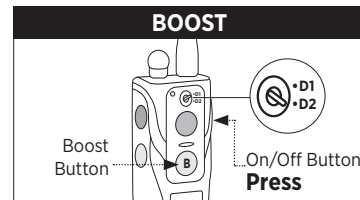

Move the toggle switch up for "D2."  
Hold down the on/off button and the brown boost button.

3. Once you see the rapidly blinking light, release the buttons. The transmitter will continue to rapidly blink until the next step is completed.
4. Hold down the HANDSFREE SQUARE button. Release the button once the rapidly flashing light on the transmitter and the HANDSFREE SQUARE both show a solid light.



5. Release all buttons. The HANDSFREE SQUARE should now be coded.
6. Up to 14 HANDSFREE SQUARES can be paired with one transmitter and can have duplicate functions. For example, 4 can be paired for Pager, 5 can be paired for Nick, and another 5 can be paired for Constant.

**Caution!**

Only 14 HANDSFREE SQUARES can be paired. When a 15th HANDSFREE SQUARE is paired, the initial 14 that were paired will reset and need to be paired again.

## 5. RECEIVER FITTING

The receiver/collar should be fitted so that the surgical stainless steel contact points press firmly against the dog's skin. When properly fitted, you should be able to fit a finger or two snugly in between the contact points and your dog's skin. When properly fitted, the receiver/collar should not move on the dog. The best location for the receiver/collar box is either side of the dog's windpipe. A loose fit can allow the receiver/collar to move around on the dog's neck. When this happens, the contact points may rub the skin and cause irritation. If the receiver/collar is too tight, the dogs may have difficulty breathing.

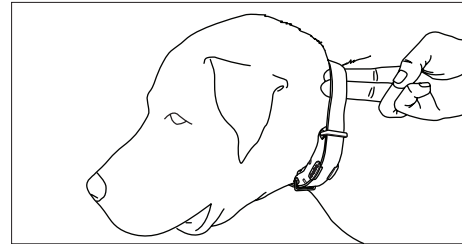

**Attention!**

Leaving the receiver in the same location on the dog's neck for an extended period of time can cause skin irritation due to the sensitivity from the contact points. If the dog is to wear the receiver for long periods, occasionally reposition the receiver every few hours so that the contact points are moved to a different location on the dog's neck and remove the receiver after 8 hours of usage. Make sure you check for skin irritation each time you use the unit.

**6. FINDING THE RIGHT STIMULATION**

The ARC800 FREE PLUS has a Rheostat Dial on the top of the transmitter (0 is the lowest and 127 is the highest). Remember that you will need to adjust the setting (upward or downward) depending on your dog's temperament and threshold for stimulation. Always start at the lowest level and work your way up. The appropriate level can be found when the dog responds to the stimulation with a mild reaction. Also, as the dog's attitude changes, especially during times of increased excitement or distraction, you may need to adjust the intensity level.

**Note:** The stimulation level can be adjusted even when the stimulation is in use. Increasing the level will not increase the Pager vibration strength as there is only one level for the Pager vibration.

## 7. MAXIMIZING THE DISTANCE

The ARC800 FREE PLUS has a maximum range of 800 meters. Depending on the way you use your transmitter, the transmitter range may vary.

To get the greatest range, hold the transmitter away from your body and avoid touching the antenna. Keep your unit properly charged for maximum signal strength.

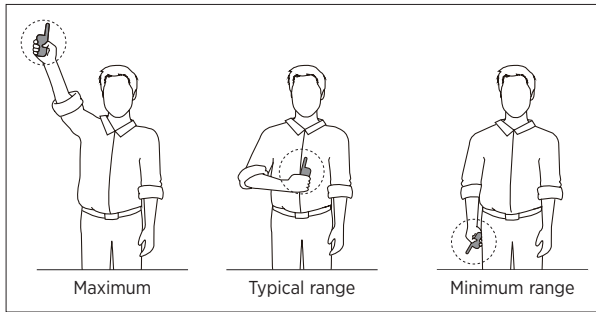

The range is reduced when the handheld transmitter's antenna is covered or in contact with your body. Refer to the following carrying methods for optimal range.

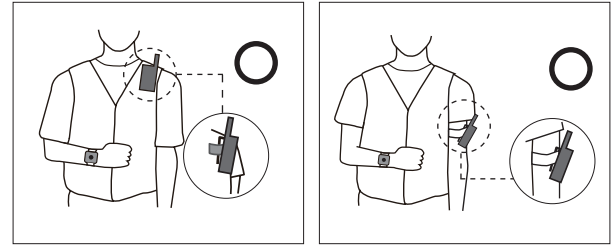

Carry the handheld transmitter with the antenna facing away from you.

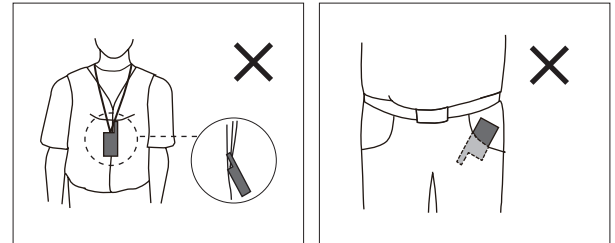

Do not place the handheld transmitter with the antenna touching your body or facing downwards.

## 8. LED INDICATOR

The LED indicator flashes every 4 seconds when the receiver is on and ready for use. The LED indicator will blink on both the transmitter and the receiver when the transmitter buttons are pressed.

The LED indicator color indicates the battery life level.

**Green = Full charge**

**Amber = Medium charge**

**Red = Needs charge**

If the unit is used while the LED indicator is red, it may shut down automatically.



### Receiver Indicator Light

When the Constant button on the transmitter is pressed, the receiver indicator light will glow steadily (either green, amber, or red based on the remaining battery life), as long as you hold the button down, for up to 12 seconds. When the Nick button is pressed, the light comes on for a fraction of a second.

## 9. CHARGING THE BATTERY

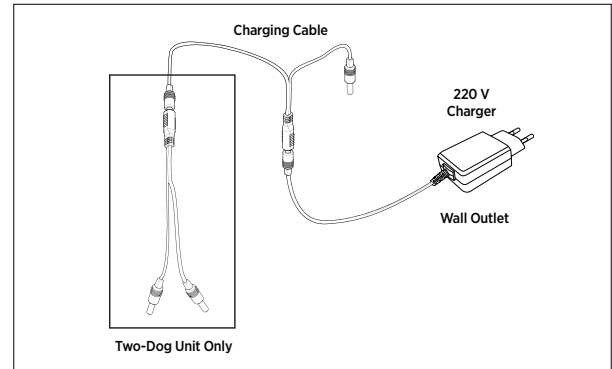

The Dogtra ARC800 FREE PLUS uses a Lithium Polymer battery.

Recharge the unit if the indicator light is red or does not come on, the transmitter LCD shows only 1 bar on the indicator, or the system will not stay on when any button is pressed.

**NOTE 1:** Only use Dogtra-approved batteries, chargers, and accessories for your Dogtra e-collars. This will prevent any damage that can be incurred from attempting to use a different charger.

**NOTE 2:** The unit has a partial charge when it leaves the Dogtra facility. Upon receipt of the system, be sure to give it a full 2-hour initial charge before the first use away from any flammable substances.



**NOTE 3:** When a charger is not in use, disconnect it from the power source. Fully charge the batteries if the unit is to be stored without use for a period of 3 months or more.

**Follow the steps below to charge your system:**

1. Open the rubber plugs on the battery charging receptacles and plug in the charging cable.
2. Plug the charger into a 220-volt wall outlet or, if using the auto charger, plug into a cigarette lighter only for lithium polymer batteries. All indicator lights should glow red when properly plugged in and the unit will automatically shut off during the charging process. You will need to turn the unit on again before use once the unit is fully charged and unplugged from the battery cable.
3. The lithium polymer battery is fully charged within 2 hours. The lights will stay red during the charging process and turn green once the unit is fully charged.
4. After charging, cover the battery charging receptacles with the rubber plugs.

**Charger Info**

Manufacturer: E-SUN

Manufacturing country: CHINA

Model name: MKC-1001500SEU

INPUT: 100-240V-50/60Hz 0.4A

OUTPUT: 10V 1500mA 15.0W

**Attention!**

During battery charging, the unit must be close to the wall outlet and the wall outlet must be easily accessible for security reasons.

	<p>The GS mark, which is regulated by German law and recognized worldwide, is a <b>seal of approval for "Geprüfte Sicherheit" (Tested Safety)</b> and means that the product is in compliance with the German product Safety Law.</p>
	<p>The Conformité Européenne (CE) Mark is the European Union's (EU) mandatory conformity marking for regulating the goods sold within the European Economic Area (EEA).</p>
	<p>A Class II or <b>double insulated</b> electrical appliance is one which has been designed in such a way that it does not require a safety connection to electrical earth (ground).</p>
	<p>For indoor use only</p>
	<p>Do not dispose of your product with your household waste. It has to be disposed of in compliance with your local WEEE (Waste Electrical and Electronic Equipment) Regulations.</p>
	<p>A power supply with this marking is in compliance with the global energy efficiency regulations, including the upcoming US Department of Energy's (DoE) Level VI efficiency standard.</p>

## 10. HANDHELD TRANSMITTER LCD



The LCD screen indicates the stimulation level on the screen ranging from (0-127). The battery life indicator shows:

- 3 bars = full charge**
- 2 bars = medium charge**
- 1 bar = needs charge**

The battery life indicator only shows the remaining charge of your transmitter. To find the remaining charge for your receiver, observe the LED indicator light on the receiver.

### Care for LCD Transmitters in Cold Temperature

In cold temperatures (-12°C or below), the Liquid Crystal Display (LCD) on your transmitter may be dim or slow to respond. Wait until the display becomes visible before selecting any training level. Even though the LCD screen might be dim or slow to respond when you press the Nick or Constant button, the transmitter will still function properly. In the occurrence of extremely cold weather, the LCD screen might take a moment to respond causing the intensity level to freeze at that current level. If you turn the Rheostat Dial, the level on the screen may not change but the actual intensity from the receiver will change in agreement with the dial. In this situation, it is ideal to either wait until your transmitter is back in working order before emitting a correction or while holding the Constant button down, slowly turn the Rheostat Dial while watching your dog's reaction. Do not turn the Rheostat Dial rapidly, because the receiver will emit a static correction based on the level of the Rheostat Dial, which might not be correctly reflected on the LCD screen.

### 11. ATTACHING THE BELT CLIP

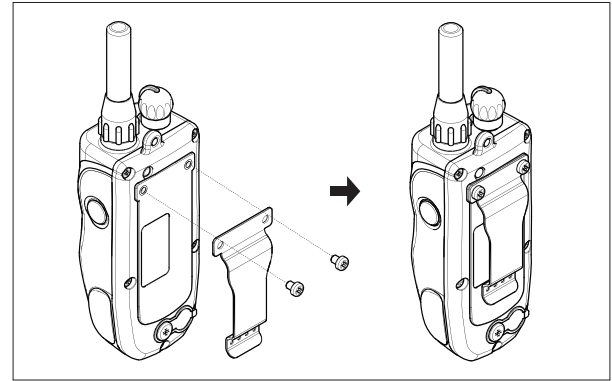

Follow the instructions below to attach the included belt clip to the transmitter.

1. Align the belt clip to the grooves on the back of the transmitter.
2. With a firm grip, screw on the belt clip's Phillips head screws with a screwdriver.

#### **Caution!**

Tighten until firmly in place. Be careful not to over tighten.

## 12. USING THE TEST LIGHT

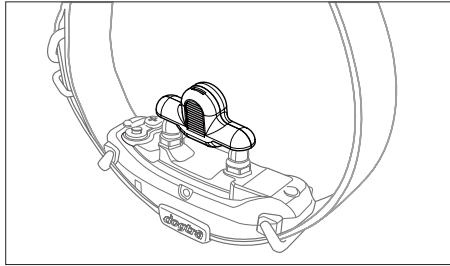

1. Turn on the receiver by pressing the on/off button. The indicator light will come on for a moment then blink once every 4 seconds, showing that the receiver is ready to use (the receiver needs to be charged if the indicator light is red).
2. Turn the transmitter on by holding down the on/off button on the right side of the transmitter. The LED will blink every 4 seconds and the LCD screen will show the remaining battery life (the transmitter needs to be charged if there is only 1 bar showing on the battery icon for the LCD transmitter screen).
3. Place the test light, included in the package contents, on the contact points as shown in the diagram. 4. Watch the test light as you press the Nick button on the transmitter. It should light up for just a moment. The higher the intensity, the brighter the test light will be.

5. Watch the test light as you press the Constant button on the transmitter. It should light up as long as the button is pressed. However, as a safety feature, the receiver will automatically stop the stimulation if the Constant button is pressed for 12 seconds or longer.
6. Turn the Rheostat Dial on the transmitter clockwise and then counterclockwise. The test light should glow brighter with higher levels of stimulation and dimmer with lower levels.

**Note:** The test light may not be visible if the intensity level is set below level ten.

## **GENERAL TRAINING TIPS**

Your dog must know some basic obedience commands before beginning training with the ARC800 FREE PLUS. A dog learns by first being shown a command, followed by lots of repetition over an extended period. As the dog becomes proficient at these commands, the trainer can introduce distractions and different locations to strengthen them.

### **Obedience Training on the Leash**

Your dog must fully understand the obedience commands (sit, stay, here, heel, and kennel) before using the e-collar for reinforcement of these commands. A leash attached to a standard collar is used to "teach" the dog the basic obedience commands (here, heel, sit, and stay). A tug on the leash/collar is used to reinforce the command. When the dog complies with the command, use positive reinforcement/praise. Once the dog understands these commands, the e-collar can be used to reinforce them.

### **Beginning E-Collar Training**

When you feel your dog understands the obedience commands on the leash we can now start with the e-collar training. With the dog on the leash and wearing the e-collar, continue with your obedience drills. Apply light stimulation (Nick or Constant) when a command is given; the stimulation can be removed as the dog complies. Through repetition, the dog learns to perform

the command. The final step is the avoidance phase in which the dog learns that he can avoid the stimulation altogether by performing your commands. When these training procedures are complete, the e-collar is used as a reminder when the dog does not comply with your commands at home or in the field. Keep your initial training sessions short and positive as dogs have a short attention span.

### **How Much Stimulation to Use**

Always start with low levels of stimulation and work your way up depending on the disposition of your dog and the given situation. By using the correct amount of stimulation to get your point across, you will have a more controllable environment and a dog that is under less stress. Animals (and humans) perform better in a less stressful environment. For more training information, please consult with a professional dog trainer.

## MAINTENANCE

### Basic Maintenance

Make sure the rubber charging cap is securely in place when the system is in use. After each training session, carefully inspect the unit for any missing parts or damage to the casing. Damaged or broken casing may affect the waterproof guarantee on the unit. After confirming that there is no damage to the casing, rinse the receiver and clean out any dirt or debris.

### Storage Maintenance

The unit should be fully charged before storing for extended periods. While in storage, the unit should be given a full charge once a month and before the first use. Store the units in room temperature. Do not keep the units exposed to extreme climates.

### Troubleshooting

If the unit is malfunctioning, please refer to the “Troubleshooting Guide” before sending it to Dogtra for service. If you have any questions or concerns, you may email them to [info@dogtra-europe.com](mailto:info@dogtra-europe.com), or call customer service at +33 (0)1 30 62 65 65.

## TROUBLESHOOTING GUIDE

### 1. My dog is not reacting to the collar.

- Make sure the unit is turned on : Place the two red dots together to turn on the receiver and push the black button on the transmitter until it illuminates to turn on the transmitter.
- Be sure the collar strap is tight enough so both contact points are touching the dog’s skin.
- The contact points may be too short for the dog. To place an order for longer contact points that are more appropriate for your dog, please call +33 (0)1 30 62 65 65 or email us at [info@dogtra-europe.com](mailto:info@dogtra-europe.com). If you are already using the longest contact points available, you might need to trim down the hair on the dog’s neck so both contact points are touching the dog’s skin.
- The intensity level may be too low for your dog. Keep increasing the stimulation until the dog responds, usually with neck movement, head shaking, looking over its shoulder, etc. (response may be very subtle).

### 2. The test light comes on, but I do not feel any stimulation.

- Your tolerance may be higher than your dogs. We recommend placing both contact points on your inner wrist, where the sensitivity is higher, in order to test the unit.

- The battery may be low, so check the LED light for battery life.
- If you have a full charge and you have done all of the above, your unit may need to be serviced. Please contact customer service at [info@dogtra-europe.com](mailto:info@dogtra-europe.com) or +33 (0)1 30 62 65 65.

### **3. The transmitter has no range or stimulation is less when the dog is farther away.**

- The antenna(s) may be damaged. To order parts, please contact customer service at +33 (0)1 30 62 65 65 or go to [www.dogtra-europe.com](http://www.dogtra-europe.com).
- The range indicated on the unit's box is for flat terrain. Heavy brush, trees, hills, or moisture will affect the range of your unit. For best range, hold the transmitter vertically above your head, and/or try moving to higher ground.
- Any electrical conductors will affect the range, such as cars, chain-link dog runs, metal building, and radio towers. For best results, operate away from these structures.

### **4. My unit is not holding a charge.**

- The batteries might not be charged properly, or the charger, splitter, and the charging port needs to be looked at. If you suspect your charger/splitter is not functioning properly, please contact customer service at [info@dogtra-europe.com](mailto:info@dogtra-europe.com) or call us at +33 (0)1 30 62 65 65. You can send in your charging units to have us inspect them.

- The charging pin may be damaged. Inside the charging port, there is a metal pin that should be standing straight up and stiff. If the pin is wobbling, broken, or missing, you will need to send the unit in to the Repair Department. The charging port must be clean prior to charging; clean the dirt out with a cotton swab and some rubbing alcohol. If the dog is in salt-water, be sure to rinse the receiver and charging port with clean water.
- For Dogtra units over two years old from the purchase date, the batteries may need to be replaced. You can replace them yourself by contacting Dogtra. But, damages incurred to the unit due to improper battery installation are not covered under any warranty and any other unauthorized servicing or tampering with the unit voids the warranty. This will be up to the user's discretion. If you are still having problems after replacing the batteries, Dogtra strongly recommends sending the unit in for inspection.

# WARRANTY AND REPAIR INFORMATION

## Two-Year Limited Warranty

Dogtra-Europe provides the original purchaser with a 2-YEAR LIMITED WARRANTY for the products sold by Dogtra-Europe and its authorized distributors/retailers. The warranty begins from the date of the original purchase. The replaceable batteries of YS100, iQ No Bark Collar and iQ CLiQ are not covered by Warranty.

\* The cost of shipping products under warranty back to Dogtra-Europe is the customer's responsibility. Dogtra-Europe will provide/pay (via regular ground service) the shipping cost back to the customer. Any expedited shipping service will be at the customer's expense.

If a repair is not covered by warranty, the cost of Parts, Accessories, Labor fees, and Shipping fees incurred are the customer's responsibility. Labor fees will be variable depending on the extent of the work required.

## To Qualify for the Dogtra Warranty

A proof of purchase is required to initiate repair work under warranty. We strongly recommend keeping the original receipt.

## Not Covered Under Warranty

Dogtra-Europe DOES NOT cover the cost of repairs and replacements due to misuse by the owner or dog, improper maintenance, and/or lost units.

Any water damage on the Water Resistant Transmitters of the **Dogtra 175NCP, 180NCP, 200NCP, 400NCP, 410NCP, iQ CLiQ and iQ PLUS** Series, and the Water Resistant Receivers of the **RRS, RRD, and RR Deluxe**, will not be covered. All replacement costs for either the transmitter or receiver will be the owner's responsibility. The warranty does not cover failure resulting from damage, abuse or loss of parts. The warranty is void if the unit has been altered or an unauthorized person has damaged the unit while attempting repair work. Battery replacement by the customer during the warranty period is not recommended. If the customer chooses to replace the batteries, any damage to the unit during the change-out by the owner will void the warranty. The removal of serial numbers from any Dogtra products will void the warranty. Dogtra reserves the right to retain and discard any parts or accessories that have been found damaged upon replacement and repair.

## Out of Warranty Repair Work

For repair work that is no longer covered by warranty, the cost of repair will include parts, labor and shipping. The owner will be informed about the repair costs before the product is repaired. Write a note briefly explaining the problem. Include your name, address, city/zip code, phone number and email address.

## Procedure for Repair Work

If the unit is malfunctioning, please refer to the "Troubleshooting Guide" in the Owner's Manual and call customer service at +33 (0)1 30 62 65 65, for technical support, before sending it to Dogtra-Europe for Service. The cost of shipping products under warranty back to Dogtra-Europe is the customer's responsibility. Dogtra-Europe is not responsible for units damaged or lost in transition to Dogtra. Dogtra-Europe is not responsible for loss of training time or inconvenience while the unit is in for repair work. Dogtra-Europe does not provide loaner units or any form of compensation during the repair period. A copy of the sales receipt showing the purchase date is required before warranty work is initiated. Please include a brief explanation outlining the problem and include your name, address, city/state/zip code, daytime phone number, evening phone number, and email address. If the repair costs are not covered under warranty, we will call you for payment information and authorization. For any questions concerning your Dogtra products, call us at +33 (0)1 30 62 65 65, or email us at [sav@dogtra-europe.com](mailto:sav@dogtra-europe.com).

**Send repair units to  
Dogtra-Europe  
12-14, Rue Augustin Fresnel  
78310 Coignières, FRANCE**

The diagrams and representations in the manual may differ slightly from the actual product depending on the model type.