

CANE CREEK[®]



TIGON



We are a company of riders...

From our roots with the world's first threadless headset to the introduction of the eeWings titanium crankset, we have always approached cycling from a rider's perspective – with wonder and curiosity.

Riding a bike isn't just something we do, it's part of who we are – enriching our lives every time we sit in the saddle. It's our therapist, our best friend, our link to the kid in all of us – smiling from ear to ear pedaling to the end of the block and back for the first time. For us, being on a bike is joy and we know that the dedicated riders who choose Cane Creek products feel the same way.

For that reason, we strive to constantly make the act of riding better – in whatever form that may take. This is the lens we look through when we conceive, design, test and manufacture Cane Creek components. We look to the rider – to ourselves – on the bike and ask, "How will this improve the ride?"

It's our belief that a cycling component brand must be about more than just balance sheets, income statements and manufacturing quotas. Simply because a product may be profitable doesn't mean it's worth making. If it does nothing to make riding better – through innovative design, superior performance and quality craftsmanship – then, simply put, we don't do it.

At Cane Creek we are riders first and we know the difference that cycling makes in our lives and our customers lives. We know that every time someone chooses a Cane Creek product they are choosing to trust us with something that makes their life better.

We will honor that trust by making sure that every product we release – from a simple bearing to a four-way adjustable shock – is the best it can possibly be.

Table of Contents

4	Safety, Warning Information
6	Introduction and Registration
7	Features Overview
8	Product Anatomy
9	Adjuster Basics
11	Frame Clearance
12	Installation
14	Coil Installation
15	Setting Sag
17	Ramp Tube Adjustment
19	Service and Maintenance
20	Warranty Information

Safety and Warnings

The rear shock is an important part of your bike. Before installing and using your new rear shock, refer to your bicycle manufacturer for coil shock compatibility and carefully read this owner's manual to learn the correct installation and adjustment procedures of the shock.

Warning

Improperly installed and/or adjusted shocks can cause serious harm or death and may severely damage your bike.

Warning

A broken or malfunctioning shock may cause loss of vehicle control and result in **SERIOUS INJURY OR DEATH**. If the shock ever loses oil, air or makes unusual noises, stop riding and have the shock inspected by a Cane Creek Authorized Suspension Service Center or call the Cane Creek Customer Service Team.

Warning

Modification, improper service or use of aftermarket replacement parts voids the warranty and may cause the shock to malfunction, resulting in loss of vehicle control and **SERIOUS INJURY OR DEATH**. Do not modify your bike frame or shock. Use only genuine Cane Creek Double Barrel parts.

Safety and Warnings

Follow service maintenance recommendations. Shock service should be performed by a Cane Creek Authorized Suspension Service Center or a properly equipped professional suspension shop with Cane Creek tools. **Visit www.CaneCreek.com to locate a Cane Creek Authorized Suspension Service Center** or for the most up to date service revisions..

Cane Creek rear shocks contain a nitrogen charge in the reservoir. Opening a nitrogen pressurized shock is dangerous and can result in **SERIOUS INJURY OR DEATH**. The shock should only be opened by a Cane Creek Authorized Suspension Service Center.

Switching units between different bikes may not only decrease the shocks performance but might also cause damage to the bike and can result in **SERIOUS INJURY OR DEATH**. Always contact Cane Creek or Cane Creek Authorized Suspension Service Center to verify compatibility before switching a shock from one bike to another.

Any improper servicing procedure with a Cane Creek shock with “stuck down” condition can lead to **SERIOUS INJURY OR DEATH**. Contact Cane Creek or an Authorized Suspension Service Center for repair.

Introduction and Registration



Congratulations on the purchase of your Cane Creek Double Barrel rear shock.

Cane Creek has been supplying revolutionary suspension technology to the bicycle market since 2005. Based on a foundation of precision quality and cutting-edge innovation, our rear shocks represent the pinnacle of high-performance bicycle suspension systems. Cane Creek technology offers the broadest adjustment range available giving you the control to tune your shock, your way, for your bike. This owner's manual is your reference guide to understanding and tuning your rear shock. It also provides important information about proper installation, set-up and maintenance of your shock.

For product registration or questions,
visit **www.CaneCreek.com** or contact us.
828-641-9560.

Features Overview

END EYE	Open ID	ID w/Bushing	Trunnion
	15.02mm	12.7mm	54mm Width / M10 Threads
Damper Adjustments		Abbreviation	Adjustments
3mm adjustment tool integrated into the valve body			
Low Speed Compression		LSC	12 positions
Low Speed Rebound		LSR	15 positions
High Speed Compression		HSC	1 turn
Climb Switch		CS	2 positions
Spring Rates	Minimum	Maximum	Sag
Ramp Tube Air Pressure	0psi	30psi	Recommended 25% - 35%
Coil Preload	1 turn	6 turns	

Count of adjuster positions may vary slightly with some shock builds. The range of adjustment will remain the same.

Product Anatomy

TIGON

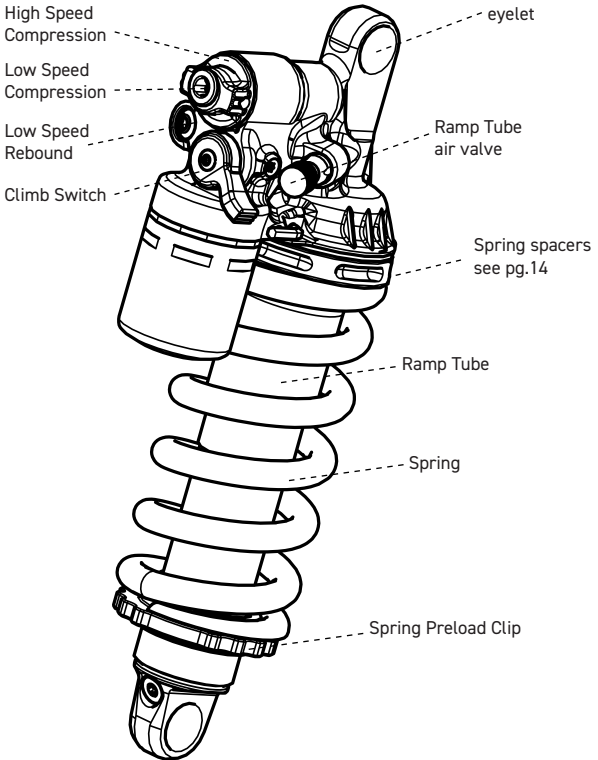

Adjuster Basics

Low Speed Compression (LSC)

(-)Reducing LSC softens the bike's suspension, allowing the bike's shock to be more active over small bumps, gradual bermed corners and rollers.

(+)Increasing LSC stiffens the shock for greater power transfer and increased pedaling efficiency

High Speed Compression (HSC)

(-)Reducing HSC allows the bike's suspension to compress very quickly through its travel. This helps keep the tires in contact with the ground, maintaining traction and control

(+)Increasing HSC enables the shock to absorb big impacts as it helps the shock resist harsh bottom outs.

Low Speed Rebound (LSR)

(-) Reducing LSR Helps the shock return back to full travel faster – This helps resist packing up while riding over bump after bump. Reducing LSR can help increase the sensation of “plushness” as well as increase traction over washboard style obstacles.

(+)Increasing LSR acts to help stabilize the bike's frame by slowing down the speed at which the shocks returns back into position – This helps maintain traction and decrease feedback while climbing technical trails.

When backing out your adjusters, **BE CAREFUL NOT TO OVER-TORQUE.** When you feel resistance - **STOP.**

You won't feel a hard stop, you will feel resistance.

Turning farther **WILL DAMAGE YOUR SHOCK.**

Adjuster Basics

Integrated 3mm Tool -

All damper adjusters use a 3mm hex tool which is integrated into the valve body and held in place with magnets. Check that the tool is properly secured at every ride and ensure that both the tool and valve body are clean and free of debris when re-installing the 3mm tool. This tool can also be inserted into the HSC knob to aid in making adjustments.

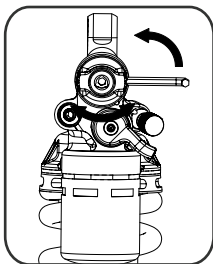
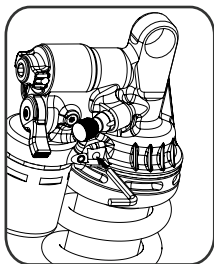

Climb Switch-

The CS lever creates a firmer feel for pedaling on road sections or singletrack climbing. Turning this lever to the counter-clockwise position increases support from the damper which reduces rider-influenced motion.

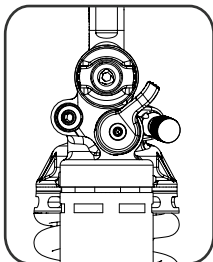
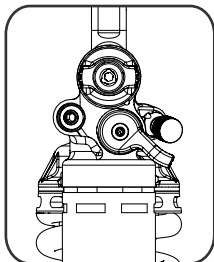

Frame Clearance

It is critical to check for clearance between your frame and shock at all points of travel during installation of the shock. The eye to eye and stroke measurements of the shock must match what is specified and approved by the frame manufacturer.

Follow the steps below carefully to ensure proper clearances and avoid damage.

These steps must be followed when installing a new shock to your frame to ensure proper clearance between your frame and the shock at all points of travel.

1. Remove the spring from the shock.
Refer to coil installation section (pg.14).
2. Install the shock to your frame using the appropriate hardware as specified by your frame manufacturer. Ensure there is no air in the Ramp Tube and that the Climb Switch is in the off position.
3. Slowly compress the suspension fully through its travel while ensuring there is no interference between the shock and the frame.
4. If there is sufficient clearance, remove the shock to install the coil.
5. Reinstall the complete shock to the frame to set sag.

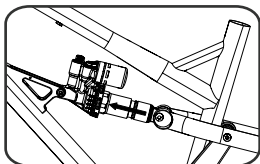
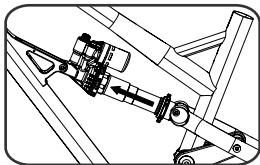

Installation

Installation of the shock requires the use of the appropriate hardware for your specific frame. The mounting points of the shock are a standardized size and additional hardware is typically needed to fit the shock to each frame. Shock hardware may be needed to properly take up the width and thickness of the frame's mounting points and bolts. The size and type of shock hardware required should be listed by the manufacturer or by measuring the existing hardware on the original shock.

For eyelet bushing and hardware installation information, please visit

www.CaneCreek.com

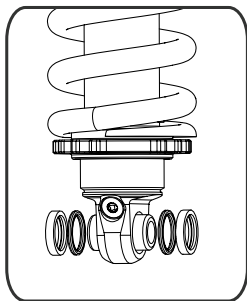
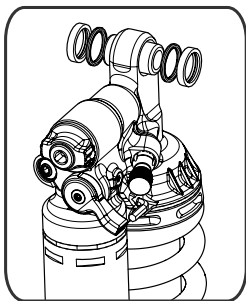

***For some hardware, spring and spring preload clip will need to be installed before lower hardware**

Installation

1. With the appropriate hardware installed to the shock eyelets, mount the shock to the frame by first inserting the mounting bolts. Do not force the shock in place if there is any fitment interference with the frame.

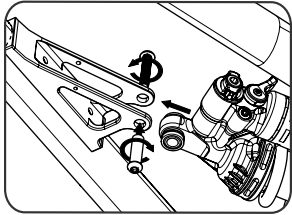

2. Torque all mounting bolts to the frame manufacturer's specifications.

3. Ensure all hardware is secure and there is no side to side movement allowed at either mounting point.

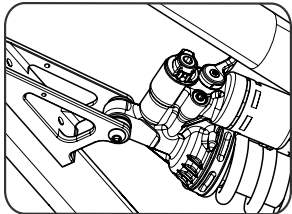

Coil Installation

Selecting the appropriate spring rate is an important variable in achieving optimal set-up of a coil shock. Your ideal spring rate will be based on rider weight, frame design, and riding style. Riding on a spring that is not appropriate for your body weight can cause **SERIOUS INJURY OR DEATH** and damage to the bike and shock.

Spring Removal and Installation

To remove the spring, turn the spring preload clip counterclockwise to release preload. Remove circlip and preload clip then remove spring from the bottom of the shock. On frames with long mounting axles, it may be necessary to remove the mounting axle before the spring can be removed.

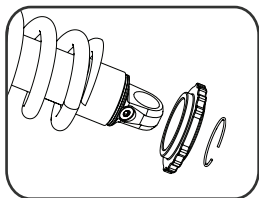

To install spring, **make sure the correct spacers are installed before the spring** (see pg.14). Install spring and make sure to **reinstall the circlip**.

⚠ Warning

The circlip is vital to spring installation. Not installing the circlip can cause **SERIOUS INJURY OR DEATH** and damage to the bike and shock.

Coil Installation

210 Standard / 185 Trunion

(all 210 standard and 185 Trunion shocks come with 1x 2mm spacer.

Spacers are to be installed before the spring.

Spacer	2mm	2mm	2mm	2mm	2mm	2mm	2mm
Spring	350	400	450	500	550	600	650
Preload clip	↑		Facing spring		↑		

230 Standard / 205 Trunion

(all 230 standard and 205 Trunion shocks come with 2x 2mm and 1x 8mm

spacers. **Spacers are to be installed before the spring.**

Spacer	2mm 2mm 8mm	2mm 2mm 8mm	8mm	2mm 2mm	2mm 2mm	2mm	
Spring	350	400	450	500	550	600	
Preload clip	↑		Facing spring		↑		

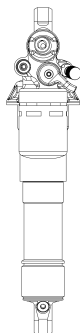

210/185



230/205



Tigon spring preload clip is directional and based on the shock size. Make sure the spring preload clip is installed correctly orientation before installing the spring.

Setting Sag

Sag is the point at which your shock is compressed under neutral riding weight. This is the most important setting of your shock and will have the greatest impact on the shock's effectiveness. Typical recommended sag for shocks is between 25% and 35% of the shock's travel. The best setting for you will be determined by your specific ride feel and suspension kinematics. We recommend a starting point of 30% of shock travel but this may need to be adjusted to your needs.

For updated tutorials and suggestions, visit www.CaneCreek.com.

⚠ Set sag with Opsi in Ramp Tube ⚠

If less than 1 full turn of preload engagement does not yield enough sag, you will need to change to a lower spring rate. Conversely, if you require more than 3 turns of preload to reach your desired sag, it is likely that you can achieve better performance from the shock with the next spring rate up.

Increasing Spring Preload

Increasing the preload will increase the starting spring rate of the coil, as well as increasing ride height and reducing sag.

To increase the preload on your spring, turn the spring preload clip clockwise (ideally, no more than three full rotations).

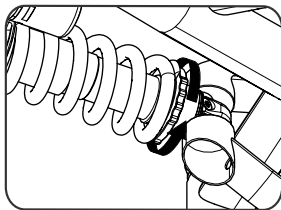

Setting Sag

Reducing Spring Preload

Reducing the preload will decrease the ride height and increase sag. To reduce the preload on your spring, turn the spring preload clip counter-clockwise (Make sure the spring preload still has 1 full turn of preload engagement when reducing preload).

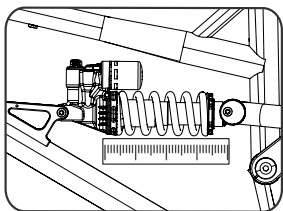

1. Mount the bike in your normal riding gear. Ensure the Climb Switch is in the Open position, the ramp tube is free of air, the bike is on a level surface, and your weight is centered over the bottom bracket as you are in a normal riding position.
2. Using the sag indication on the side of the shock, determine the desired amount of sag.
3. Add or remove spring preload as needed and repeat the process until desired sag amount is achieved.

Stroke (mm)	Percentage (%)	Sag (mm)
50mm	25-35%	12.5mm-17.5mm
55mm	25-35%	13.75mm-19.25
60mm	25-35%	15mm-21mm
65mm	25-35%	16.25mm-22.75mm

Ramp Tube Adjustment

RAMP Tube Technology — Patent Pending

The Tigon shock has a unique patent pending air spring, called the Ramp Tube. It is designed to add progression to the shock. This adjustment causes the spring rate to ramp up as the shock compresses into its travel which will further increase mid stroke support as well as bottom out resistance. This allows riders that are jumping sections of trail and experiencing large compression events to be supported while still maintaining traction that a coil shock provides.

Air pressure in the ramp tube should be only used to achieve more progression and should not be used to achieve your desired sag. If sag is set correctly using only the coil spring and preload, but the bike uses all of the shock's travel too easily or too frequently, consider adding pressure into the ramp tube. **A maximum of 30psi can be added to the Ramp Tube.**

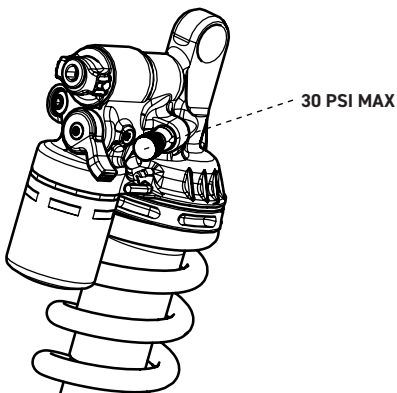

Ramp Tube Adjustment

Below are examples of how 10psi, 20psi, and 30psi increase progression as a shock compresses to bottom out. To use the ramp tube adjustment properly, is it critical to first set sag correctly, second, to ride the shock with 0psi and adjust rebound and compression settings to a desired feel, and third, to add air to the ramp tube until the desired progression of the shock is achieved.

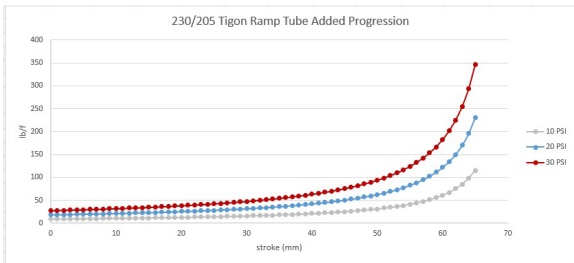
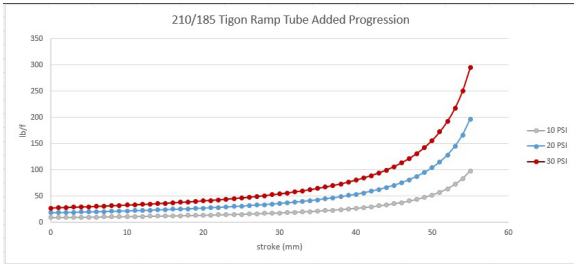

⚠ after adding air to ramp tube recheck sag as you may need to reduce preload or reduce spring rate.

Service and Maintenance

Extreme usage like downhill racing or ebikes may shorten service intervals.

Service and Maintenance	Every Ride	15 Hours	100 Hours or annually
Check sag - Reset if necessary	X		
Clean and inspect shock exterior	X		
Clean with mild soap and water		X	
Inspect external air sealing surfaces for scratches or damage.		X	
Inspect and clean air valve threads to prevent dirt from entering air spring during inflation.		X	
Clean around spring adjustment nut to prevent damage to the threads on shock body.		X	
Inspect mounting hardware and bushings.		X	
Service damper and air spring performed by a Cane Creek Authorized Service Center.			X

Warranty Information

LIMITED ONE (1) YEAR WARRANTY ON SUSPENSION PRODUCTS

Subject to the limitations, terms and conditions hereof, Cane Creek warrants, to the original retail owner of each new Cane Creek suspension product, that the Cane Creek suspension product, when new, is free from defects in materials and workmanship. This warranty expires one (1) year from the date of the original Cane Creek suspension product retail purchase from an authorized Cane Creek dealer or from a Cane Creek authorized Original Equipment Manufacturer where Cane Creek suspension is included as original equipment on a purchased bike, unless otherwise dictated by requirement of law.

TERMS OF WARRANTY

This warranty is conditioned on the Cane Creek suspension product being operated under normal conditions and properly maintained as specified by Cane Creek. This warranty is only applicable to Cane Creek suspension purchased new from an authorized Cane Creek source and is made only to the original retail owner of the new Cane Creek suspension product and is not transferable to subsequent owners. This warranty is void if the Cane Creek suspension product is subjected to abuse, neglect, improper or unauthorized repair, improper or unauthorized service or maintenance, alteration, modification, accident or other abnormal, excessive, or improper use. Should it be determined, by Cane Creek in its sole and final discretion, that a Cane Creek suspension product is covered by this warranty, it will be repaired or replaced, by a comparable model, at Cane Creek's sole option, which will be conclusive and binding.

Cane Creek components are designed for use only on bicycles that are pedal powered or pedal assisted.

This limited warranty does not apply to normal wear and tear, malfunctions or failures that result from abuse, neglect, improper assembly, alteration or modification, improper or unauthorized repair or maintenance, crash, accident or collision, or other abnormal, excessive or improper use.

Warranty Information

Wear and tear parts are subject to damage as a result of normal use, failure to service according to Cane Creek recommendations, and/or riding or installation in conditions or applications other than recommended.

Wear and tear parts include:

- Air sealing O-rings
- Bearings
- Bottom out pads
- Bushings
- Corrosion
- Dust seals
- Foam rings, Glide rings
- Rear shock mounting hardware and main seals
- Rubber moving parts
- Stripped threads/bolts (aluminum, titanium, magnesium or steel)
- Upper tubes (stanchions)

This warranty shall not cover damages caused by the use of parts of different manufacturers or parts that are not compatible or suitable for use with Cane Creek components.

THIS IS THE EXCLUSIVE REMEDY UNDER THIS WARRANTY. ANY AND ALL OTHER REMEDIES AND DAMAGES THAT MAY OTHERWISE BE APPLICABLE ARE EXCLUDED, INCLUDING, BUT NOT LIMITED TO, INCIDENTAL OR CONSEQUENTIAL DAMAGES OR PUNITIVE DAMAGES.

To the extent allowed by local law claims under this warranty must be made during the warranty period and within one (1) year following the date on which any such claim arises.

When making a claim under this Limited Warranty you will be required to provide to an authorized Cane Creek Warranty Center:

1. The Product (or the affected part) and
2. A copy of the original proof of purchase, which clearly indicates the name and address of the seller, the date and place of purchase, the product part number and if utilized, a serial number. If Cane Creek products are sold as part of a complete bicycle, the bicycle brand, model, model year, and serial number should be included.



Cane Creek Cycling Components
355 Cane Creek Rd
Fletcher North Carolina 28732
1-828-641-9560