

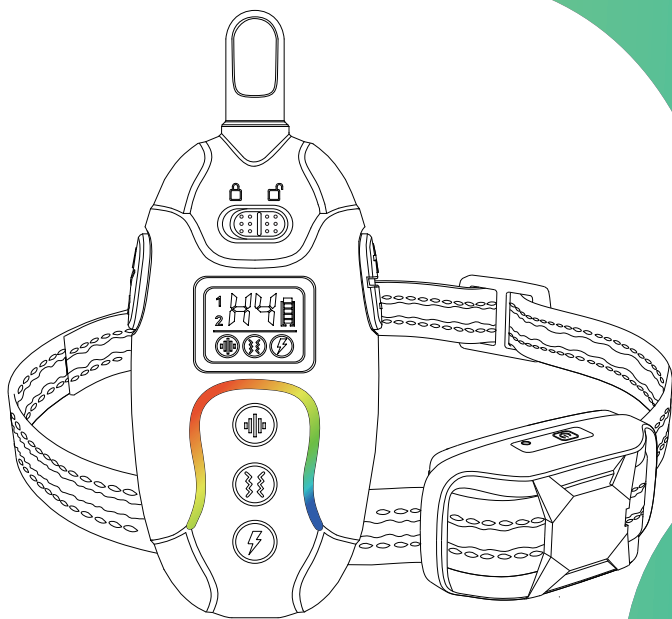

DOG TRAINING COLLAR



Model: RS1

1.Quick Start Guide

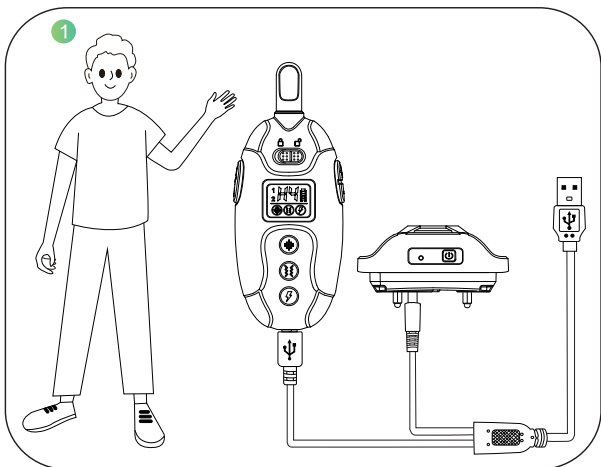

Charge the Receiver and the Remote Transmitter for 3 hours with the cable in the package box. Micro-USB is used to charge the Remote Transmitter, and 5.5DC is used to charge the Receiver.

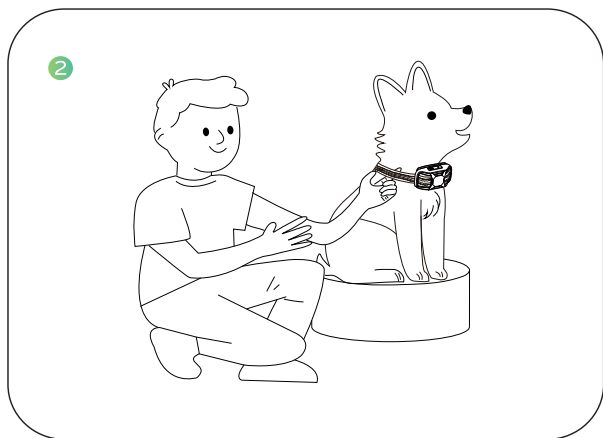

Make your dog sit down and fit the Receiver to your dog by leaving one finger space between the collar and your dog's neck. Center the contact points underneath your dog's neck, touching the skin.

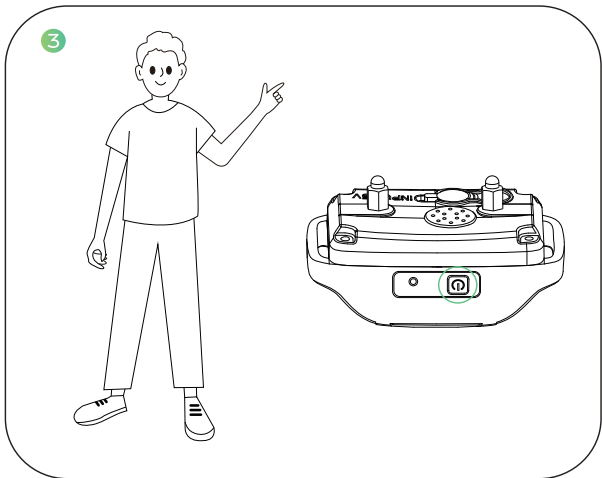

Turn on the Receiver by pressing and holding the Power Button for 2 seconds with vibration to indicate that the Receiver is powered on.

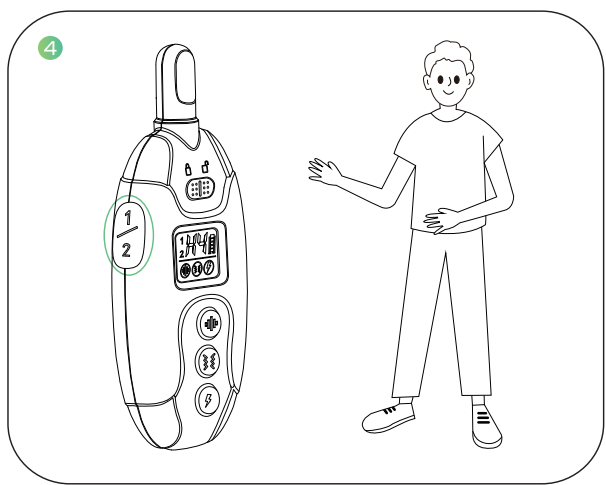

Turn on the Remote by pressing and holding On/Off(Channel) Button for 2 seconds.

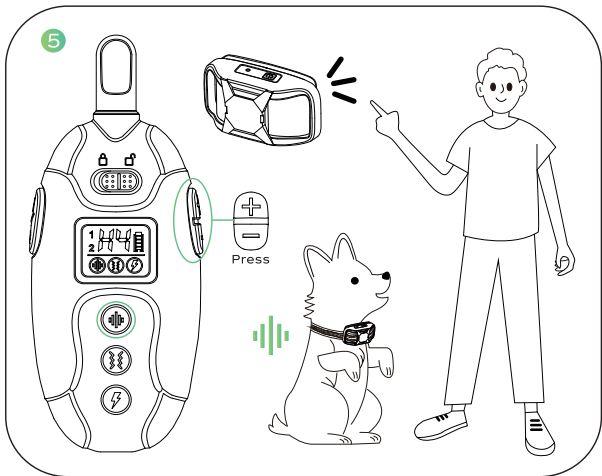

Warning Tone Command: press the Warning Tone Button, and the green indicator lights rapidly flow from both ends and meet in the middle, and the Receiver will deliver a warning tone. Press the Level Button to adjust the warning tone levels.

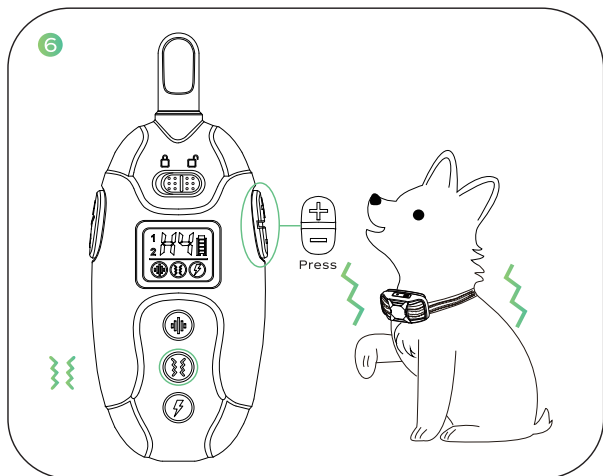

Vibration Command: press the Vibration Button, and the yellow indicator lights rapidly flow from both ends and meet in the middle, and the Receiver will deliver the vibration. Press the Level Button to adjust the vibration levels.

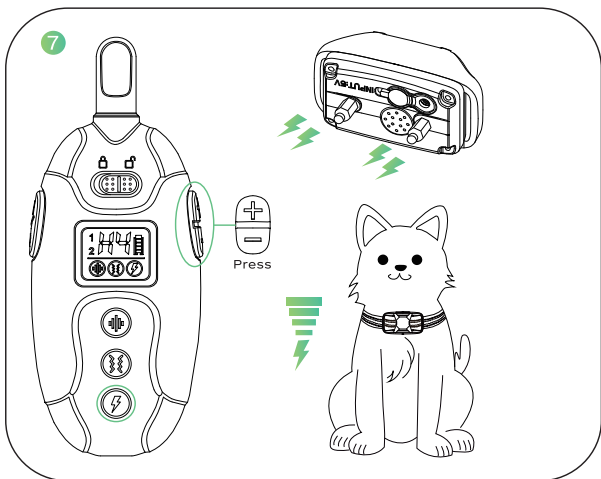

Shock Command: press the Shock Button, and the red indicator lights rapidly flow from both ends and meet in the middle, and the Receiver will deliver the static shock. Press the Level Button to adjust the shock levels.

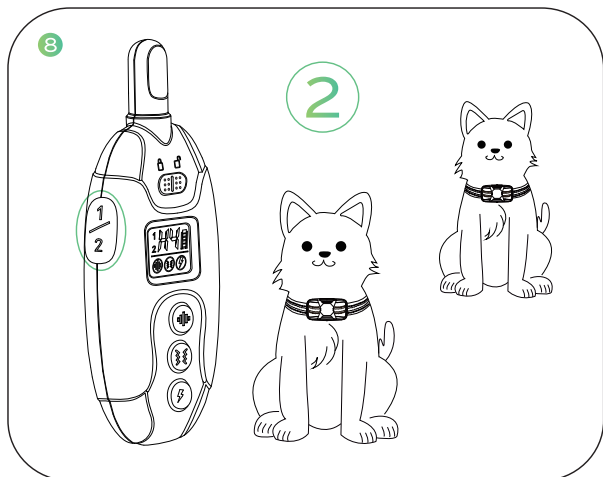

Switch the channel by pressing the On/Off(Channel) Button. This product can train up to 2 dogs.

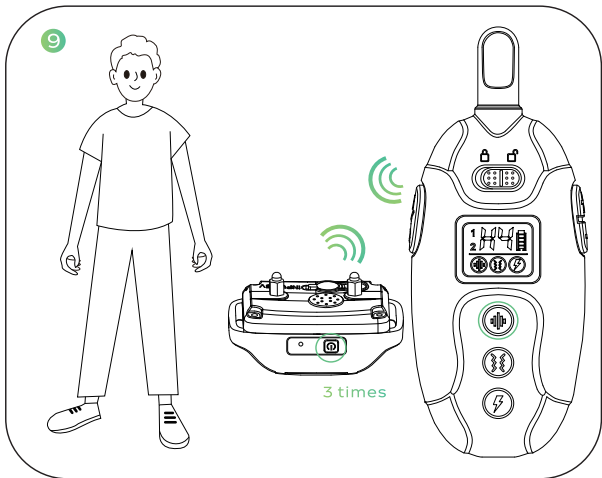

Steps to pair the Remote Transmitter to an extra Receiver:

1. Change the channel of the Remote Transmitter to Channel 2 by pressing the On/Off (Channel) Button;
2. Press the Power Button on the extra Receiver 3 times until you hear a beeping;
3. Press any one of the Warning Tone, Vibration, or Shock Button, and the Receiver will respond respectively.

Please refer to “VI. Pairing Up” on page 13 for tips on the pairing process.

Important Safety Information:

WARNING

Not for use with aggressive dogs. Do not use this product if your dog is aggressive, or if your dog is prone to be aggressive. Aggressive dogs can cause severe injury and even death to their owner and others. If you are unsure whether this product is appropriate for your dog, please consult your veterinarian or a certified trainer.

- ◆ For use with dogs over 6 months of age.
- ◆ DO NOT use it when the dog or the collar is wet.
- ◆ DO NOT press and hold shock or vibrate for more than 10 seconds to avoid physical or psychological damage to your dog.
- ◆ Your dog should not vocalize or panic when receiving stimulation. If this happens, the stimulation level is too high and you need to go back to the previous level and repeat the process.
- ◆ DO NOT charge the device near any flammable substances.
- ◆ Dog use only. Not for use on children.
- ◆ This is not a toy, and should only be operated by a responsible adult.

CAUTION

For on-leash training. Do not attach the leash to training collar. Use a regular collar in addition to the training collar.

Risk of skin damage. Please read and follow the instructions in this manual. Proper fit of the collar is important. A collar worn for too long or made too tight on the dog's neck may cause skin damage. Ranging from redness to pressure ulcers; this condition is commonly known as bed sores.

- ◆ DO NOT leave the collar on the dog for more than 12 hours per day.
- ◆ When possible reposition the collar on the dog's neck every 1 to 2 hours.
- ◆ Check the fit to prevent excessive pressure; follow the instructions in this manual.
- ◆ Never connect a lead to the collar; It will cause excessive pressure on the contacts.
- ◆ Wash the dog's neck area and the contact probes of the collar weekly with a damp cloth.
- ◆ Examine the contact area daily for signs of a rash or a sore.
- ◆ If a rash or sore is found, discontinue use of the collar until the skin has healed. If the condition persists beyond 48 hours, see your veterinarian.
- ◆ The Receiver collar meets IP67 waterproof rating, it can be submerged into water up to 1 meter for up to 30 minutes. If submerged and wet, please do not use it.
- ◆ This product comes with conductive silicone covers, please ensure they are worn on the contact points before putting the Receiver on your dog and check for the presence of the silicone cover every hour.

I. Package Content



Remote Transmitter



Receiver

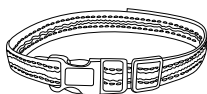

Collar



Test Bulb Tool



Metal Prongs



Silicone Caps

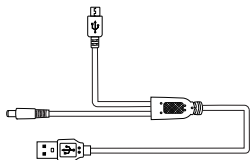

Charging Cable



User Manual

II. Product Overview

Receiver

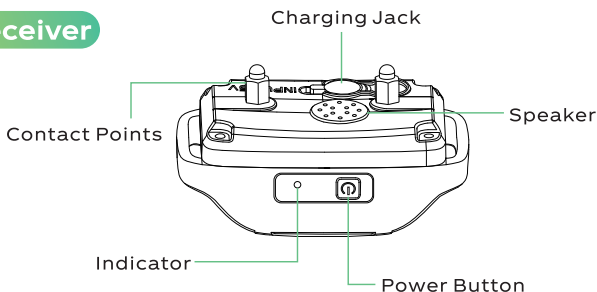

How the System Works

The Remote Training Collar is easy to use with an advanced digital display that tells you exactly what level of stimulation you are using.

The Remote Training Collar assists you in controlling your dog without a leash.

At the push of a button, your Remote Transmitter sends a signal activating your dog's Receiver. He receives a safe but annoying stimulation. He'll quickly learn the association between his behavior and your correction; in no time, you'll have a better behaved dog. The Remote Training Collar has been proven safe, comfortable, and effective for both small and large dog breeds.

Using the Remote Training Collar consistently and correctly, any basic obedience commands can be taught and will help to correct many misbehaviors that your dog exhibits.

Remote Transmitter

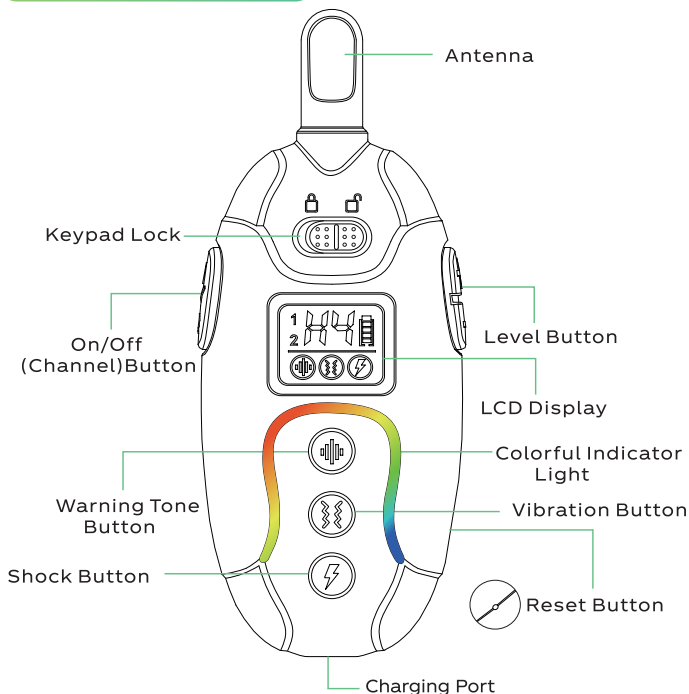

Screen

Vibration/Warning Tone/Shock Levels

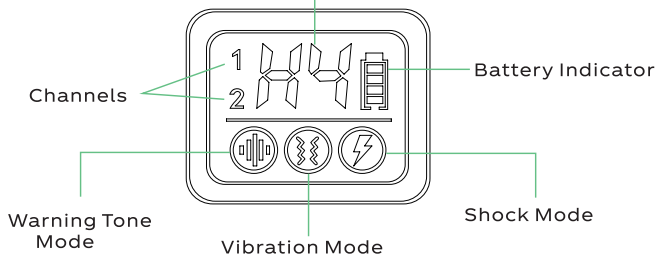

III. Setting Up

1. Charge the Product

Remote Transmitter: charge the device until the Colorful Indicator Light becomes solid green which will take around 2-3 hours.

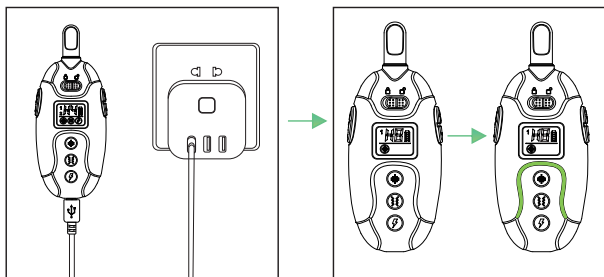

Receiver: charge the device until the Indicator becomes solid green which will take around 2-3 hours.

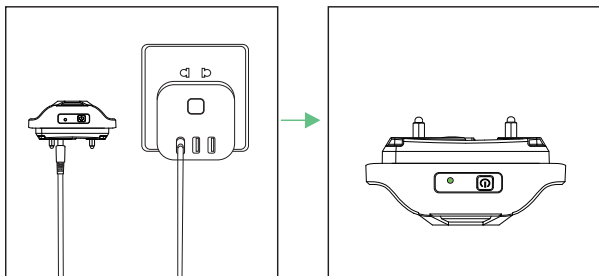

Warning:

Please use a charger with a 5V output voltage that can always be seen on the surface of it. If charged with a charger with an output voltage over 5V, the Receiver will deliver a rapid warning tone and stop charging automatically, and the Remote Transmitter will stop charging automatically with the colorful indicator rapidly blinking in red.

2. Turn On/Off the Product

Turn on the Remote Transmitter by pressing and holding the On/Off (Channel) Button for 2 seconds, the red, green and blue indicator lights successively flow from left to right, which means the Remote Transmitter is powered on.

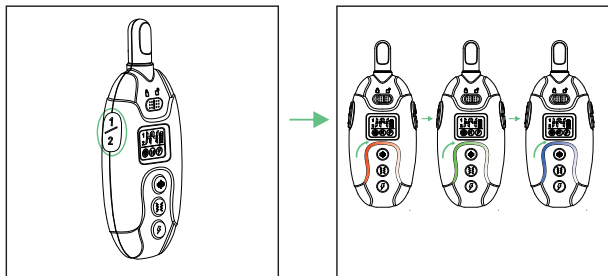

Turn off the Remote Transmitter by pressing and holding the On/Off (Channel) Button for 2 seconds, the blue indicator lights quickly flow from the middle to both ends, which means the Remote is powered off.

Turn on the Receiver by pressing and holding the Power Button for 2 seconds.

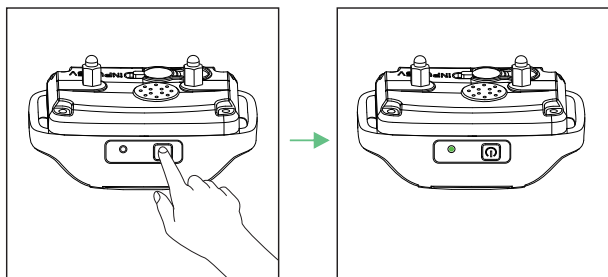

IV. Training Modes

1. Warning Tone Mode

When pressing the Warning Tone Button, the green indicator lights rapidly flow from both ends and meet in the middle, and the Receiver will deliver a warning tone. It will cut off automatically if you press and hold the Warning Tone Button for 10 seconds. There is a total of 8 levels of Warning Tones for training which you can adjust by the Adjustment Button.

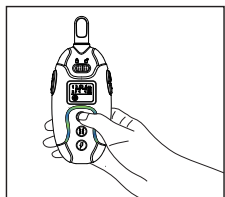

Press

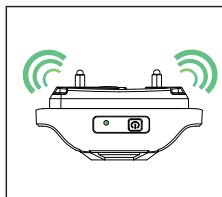

2. Vibration Mode

When pressing the Vibration Button, the yellow indicator lights rapidly flow from both ends and meet in the middle, and the Receiver will deliver a vibration. It will cut off automatically if you press and hold the Vibration Button for 10 seconds. There is a total of 16 levels of Vibration for training which you can adjust by the Adjustment Button.

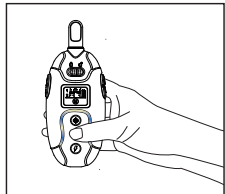

Press

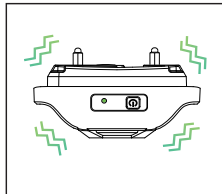

3. Shock Mode

When pressing the Shock Button, the red indicator lights rapidly flow from both ends and meet in the middle, and the Receiver will deliver a static shock. It will cut off automatically if you press and hold the Shock Button for 10 seconds. There is a total of 99 levels of Shock for training which you can adjust by the Adjustment Button.

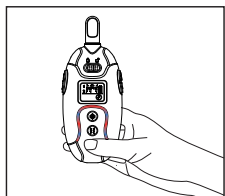

Press

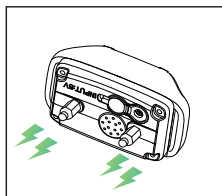

4. Switching Channels

Press the Channel Button to choose the Receiver you want to control if you have paired up two Receivers.

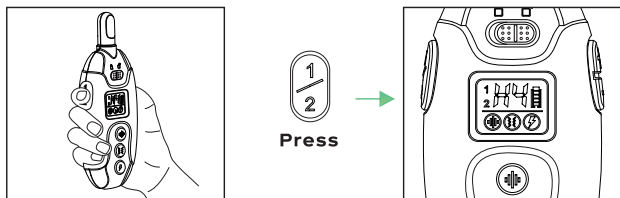

V. Fitting the Receiver

Important:

The proper fit and placement of your Receiver are important for effective training. The Contact Points with Conductive Silicone Cover must have direct contact with your dog's skin on the underside of his neck. To assure a proper fit, please follow these steps:

1. Make sure that the Receiver is turned off.
2. Let your dog stand on four feet or lay down fully (A).
3. Place the Receiver on your dog's neck close to the ears. Center the Contact Points underneath your dog's neck, touching the skin (B).

Note: It is sometimes necessary to trim the hair around the Contact Points to make sure that contact is consistent.

4. The Receiver should fit snugly, yet loose enough to allow one finger to fit between the strap and your dog's neck (C).
5. Allow your dog to wear the collar for several minutes then recheck the fit. Check the fit again as your dog becomes more comfortable with the Receiver.

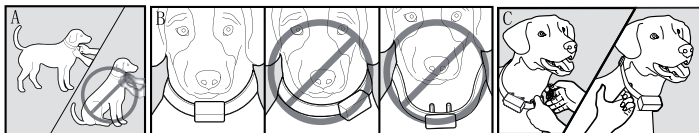

6. How to attach the collar to the Receiver ?

Follow the following A-B-C-D steps instructed to the strap.

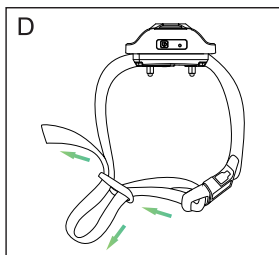
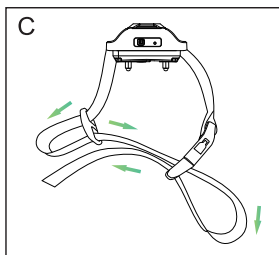
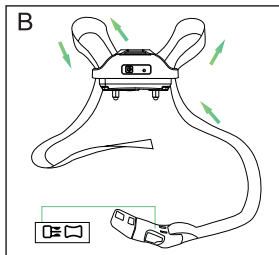
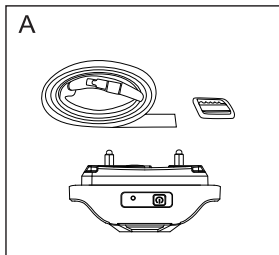

CAUTION:

Risk of Skin Damage. Too long time or too tightly fitting may cause pressure necroses, which is often misidentified as burns. Please follow the below instructions:

- Do not shave the dog's neck as this may increase the risk of skin irritation.
- Do not leave the Receiver on your dog's neck for continuous 12 hours.
- Never attach a leash to the collar.
- Never fit the Receiver too tight to your dog's neck.

VI. Pairing Up

If you feel the Receiver is not responding to the Remote Transmitter, follow these steps to pair them up.

1. Press and hold the Power Button on the Receiver for 2 seconds and the On/Off (Channel) Button to turn both of the Receiver and the Remote Transmitter on.

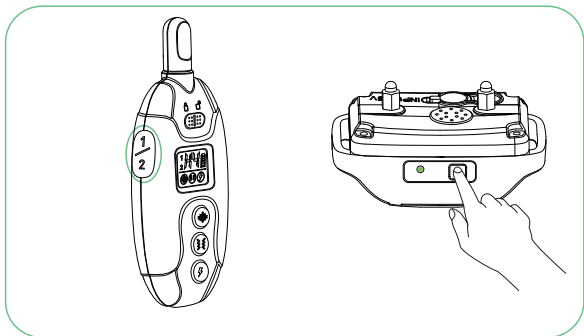

2. Press the Power Button on the Receiver 3 times to enter the Pairing Mode. You will hear a beeping and the Indicator become solid. You will now have 10 seconds to finish the pairing.

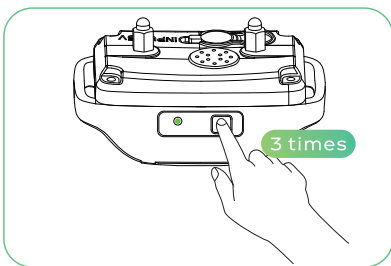

3. Press the Warning Tone Button, Vibration Button, or Shock Button on the Remote Transmitter, and the Receiver will respond correspondingly indicating that the Pairing process is completed.

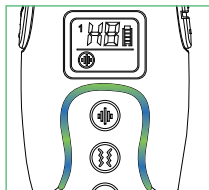
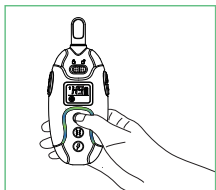

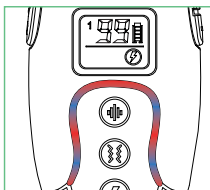
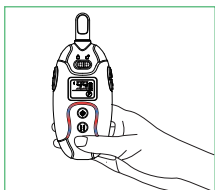
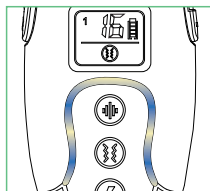
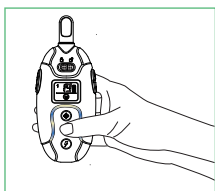

Tips:

The Receiver is paired up to Remote Transmitter in Channel 1 by factory default setting.

If you buy a new Receiver, you follow the above pairing instruction to pair up to channel 2. The system can pair up to 2 Receivers in 2 different channels.

If you can not pair the device successfully, it may be caused by signal interference. Please try in a new place or contact with our service center.

LCD Display & Indicator Definitions



Remote:

	Warning Tone Mode
	Vibration Mode
	Shock Mode
	Channel 1 and 2
	Levels for Warning Tone/Vibration/Shock
	Battery indicator



Keypad Lock

Remote colorful indicator light:

On charge	Green Indicator light slowly blinking
Fully charged	Green Indicator light become Solid
Turn on	The red, green and blue indicator lights successively flow from left to right
Turn off	Blue light flowing
Press 	Green light flowing
Press 	Yellow light flowing
Press 	Red light flowing



Slowly blinking indicates the Receiver is on

Fast blinking indicates when the Receiver is on charge

Faster blinking indicates the Receiver battery is low

Training Tip

HOW to find the best stimulation for your dog?

Important: Always start at the lowest level and work your way up. The Remote Training Collar has 8 types of Warning Tones, 16 levels for Vibration and 99 levels for Static Shock. For Warning Tone, there are 8 types of tones and there is only a frequency difference among different types. For Vibration and Static Shock, level 1 is the lowest; level 16 is the highest for Vibration and 99 for Static shock.

This allows you to choose the Stimulation level that is best for your dog. Once you have placed the Receiver on your dog, it is time to find the Stimulation Level that is best for him. This is called the Recognition Level.

A slight change in your dog's behavior, such as looking around in curiosity, scratching at his collar, or flicking his ears, indicates the Recognition Level that is best for your dog.

Follow the steps below to find your dog's Recognition Level:

1. Starting at Level 1, press the Warning Tone/Vibration/Shock Button continuously for 1 to 2 seconds. Note: When the Warning Tone/Vibration/Shock Button is held down for 10 consecutive seconds, the Remote Transmitter will "time out", and you must release and press the button again before additional stimulation can be delivered.
2. If your dog shows no reaction, repeat the Stimulation Level several times before moving up to the next level.
3. YOUR DOG SHOULD NOT VOCALIZE OR PANIC WHEN RECEIVING STIMULATION. IF THIS HAPPENS, THE STIMULATION LEVEL IS TOO HIGH AND YOU NEED TO GO BACK TO THE PREVIOUS LEVEL AND REPEAT THE PROCESS.
4. Move up through the Stimulation Levels until your dog reliably responds to the stimulation.
5. If your dog continues to show no response at the highest level of Vibration or Static Shock, check the fit of the Receiver. If your dog has long or thick hair, contact our Customer Care Center to obtain a longer set of Contact Points. Then go back to #1 and repeat the process.

If this still does not yield any results, your dog's hair will need to be trimmed around the Contact Points. If after completing all of these steps, your dog still does not indicate he is feeling the stimulation, please contact our customer service.

How to Maximize the distance?

Terrain, weather, vegetation, transmission from other radio devices, and other factors will affect the maximum range.

Hold the Remote Transmitter in a horizontal position away from your body to achieve optimum range. For maximum signal strength, keep the device properly charged.



Maximum range



Typical range



Minimum range

*Avoid touching the antenna or the range may decrease substantially.

Frequently Asked Questions

Q: Is the Stimulation safe for my dog?

A: While the Stimulation is unpleasant, it is harmless to your dog. Electronic training devices require interaction and training from the owner to achieve desired results.

Q: How old does my dog have to be before using the Remote Training Collar?

A: Your dog should be able to recognize basic obedience commands such as "Sit" or "Stay". Dogs should be at least 6 months old before using the Trainer.

Q: Once my dog is trained and has been obeying my commands, will he have to continue to wear the Receiver?

A: Probably not. You may need to reinforce training with the Receiver from time to time.

Q: Is the Receiver waterproof?

Yes. The Receiver meets IP67 waterproof rating, but make sure to keep the area dry when charging.

Note: the Remote Transmitter is not waterproof.

Q: Will I get a maximum range with the Remote Training Collar?

A: The range of the Remote Training Collar will vary according to terrain, weather, vegetation, as well as transmission from other radio devices. See "How to Maximize the Distance" on page 13 for tips on maximizing your range.

Q: How long can I continuously deliver stimulation to my dog?

A: The maximum amount of time you can press the Warning Tone/Vibration/Shock button and deliver stimulation to your dog continuously is 10 seconds. After this, the Remote Transmitter will time out, and these stimulation buttons must be released and pressed again.

Trouble Shooting

1. My dog does not respond when I press a button.

- Make sure the Receiver has been turned on.
- If your range has reduced from the first time you used the Remote Training Collar, the battery may be low in either the Remote Transmitter or the Receiver.
- Many factors can impact the amount of range you have with the Remote Trainer. For a list of these factors, see "How to Maximize the Distance" on page 17.
- Test the Receiver with the Test Bulb Tool.
 - Turn the Receiver on.
 - Hold the Test Bulb Tool to the Contact Points on the Receiver.
 - Press the Shock Button on the Remote Transmitter.
 - The Test Light will flash. At higher shock levels, the Test Bulb Tool will flash brighter.

NOTE: If the Test Bulb Tool does not flash, recharge the Receiver and re-test. If the Test Bulb Tool still does not flash, contact our Customer Care Center .

- Increase the Stimulation Level. Refer to "How to best stimulation for your dog?" on page 16 for more information.
- Make sure the Receiver's Contact Points are placed snugly against your dog's skin. Refer to "Fitting the Receiver" on page 12 for more information.

2. The Receiver will not turn on.

- Make sure the Receiver has been charged. For the initial charge, be sure to charge it for 4 hours. Subsequent charges only take 2~3 hours.

3. The Receiver is not responding to the Remote Transmitter.

- Verify the Receiver is on.
- If the indicator is blinking rapidly, fully charge the Receiver.
- If the above two solutions did not resolve the problem, please refer to "VI. Pairing Up" on page 13 to re-pair the Receiver to the Remote Transmitter.

FCC Statement

USA

This device complies with part 15 of the FCC Rules. Operation is subject to the following two conditions: (1) This device may not cause harmful interference, and (2) this device must accept any interference received, including interference that may cause undesired operation.

NOTE:

This equipment has been tested and found to comply with the limits for a Class B digital device, pursuant to part 15 of the FCC Rules. These limits are designed to provide reasonable protection against harmful interference in a residential installation. This equipment generates, uses, and can radiate radio frequency energy and, if not installed and used in accordance with the instructions, may cause harmful interference to radio communications. However, there is no guarantee that interference will not occur in a specific installation. If interference does occur to radio or television reception, which can be determined by turning the equipment off and on, the user is encouraged to try to correct the interference by one or more of the following measures:

- Reorient or relocate the receiving antenna.
- Increase the separation between the equipment and the Receiver.
- Connect the equipment to an outlet on a circuit different from that to which the receiver is connected.
- Consult customer care, the dealer, or an experienced radio/TV technician for help.

Model: RS1
Made in China
Version: V3.0

