

# DOG TRAINING COLLAR

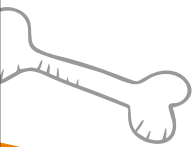

Model:P19

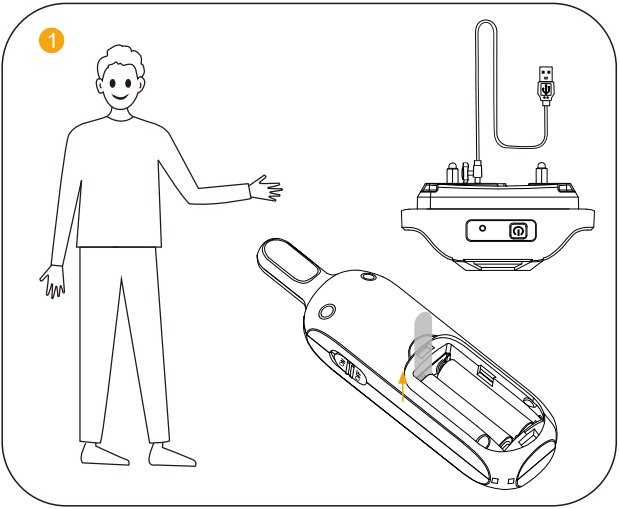



Charge the Receiver for 3 hours with the cable in package box and take off the battery separator in the Remote Transmitter compartment.

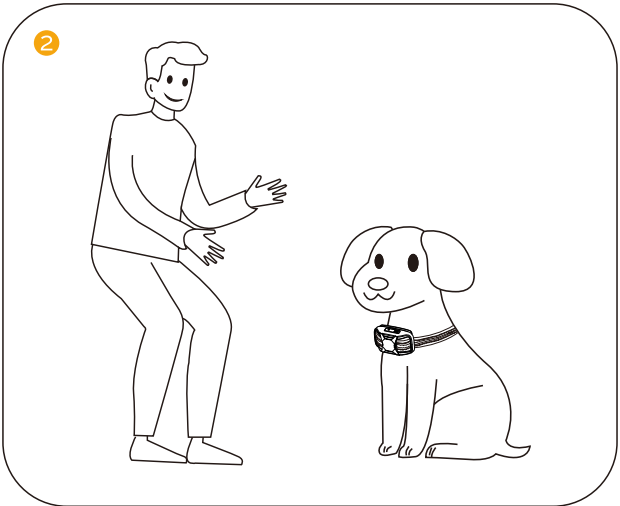

Make your dog sit down and fit the Receiver to your dog by leaving one finger space between the collar and your dog's neck.

3

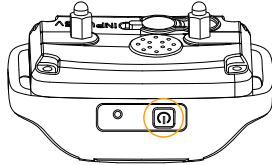
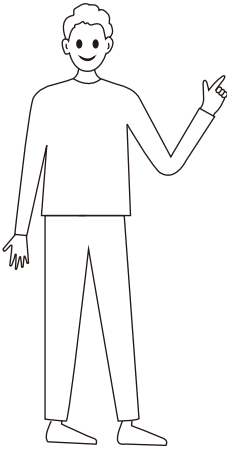

Turn on the Receiver by pressing and holding the Power Button for 2 seconds.

4

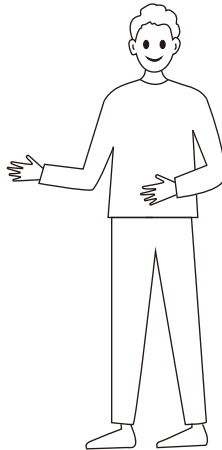
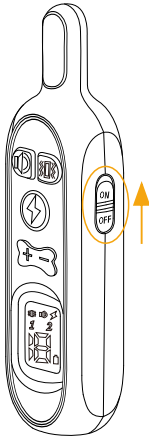

Toggle the Power Button up to turn on the Remote Transmitter.

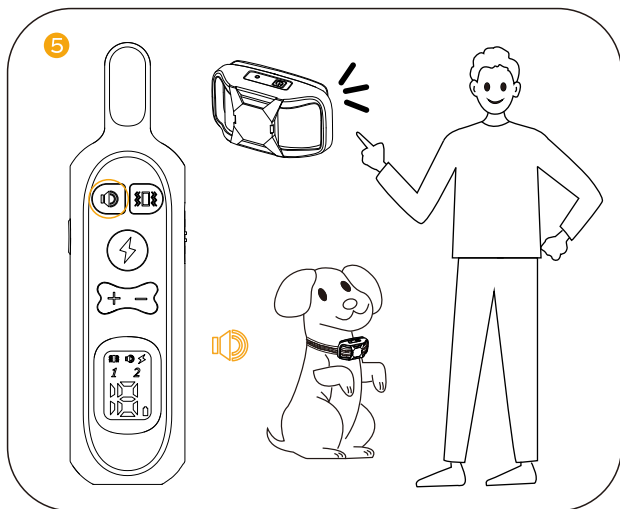

**Warning Tone Command:** press the Warning Tone Button and the Receiver will delivery warning tone. Press the Level Button to adjust the warning tone levels.

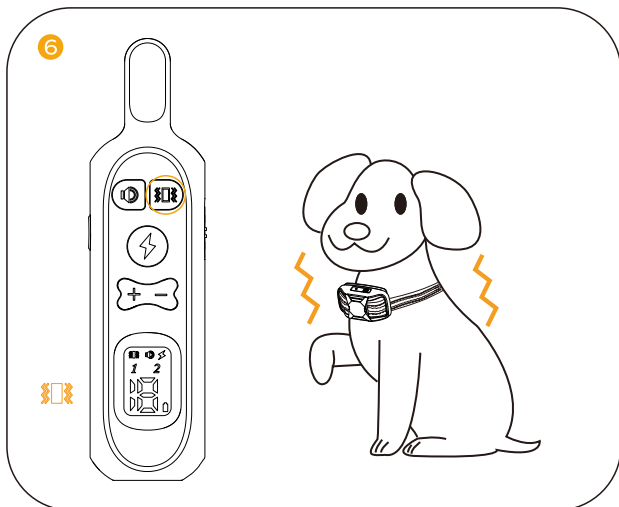

**Vibration Command:** press the Vibration Button and the Receiver will delivery the vibration. Press the Level Button to adjust the Vibration levels.

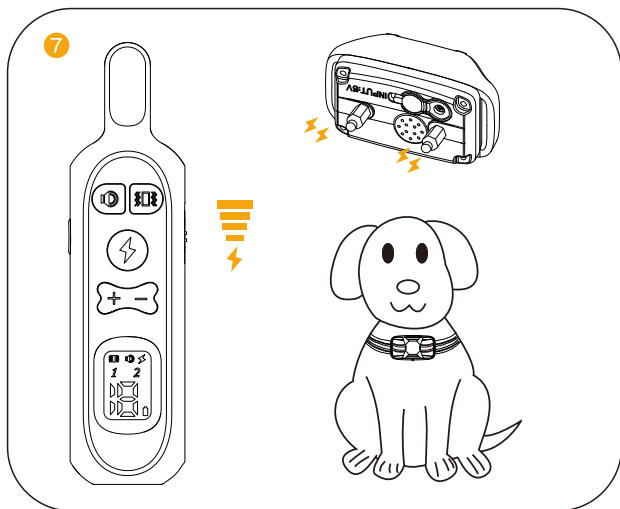

Shock Command: press the Shock Button and the Receiver will deliver the static shock. Press the Level Button to adjust the shock levels.

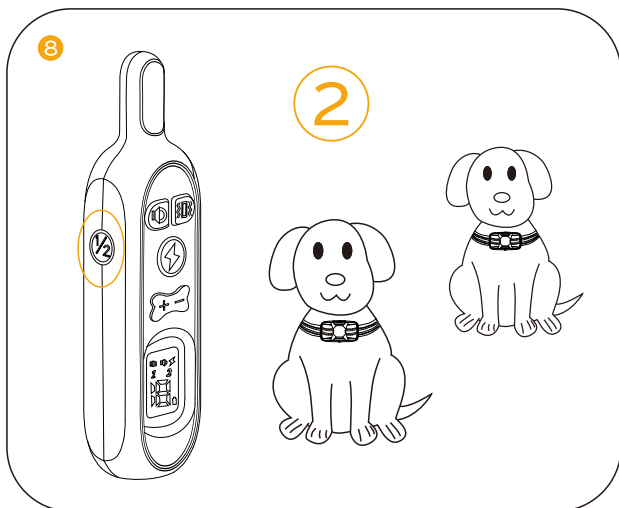

Switch the channels by pressing the Channel Button. This product is able to train 2 dogs at the same time.

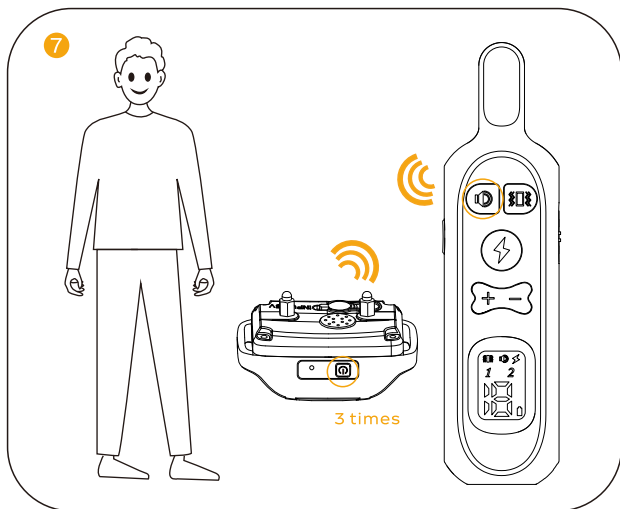

Pair the product to an extra Receiver: press the Power Button on the Receiver 3 times till you hear a beeping, then press any one of the Warning Tone, Vibration or Shock Button and the Receiver will respond respectively.

## Important Safety Information:

### WARNING

Not for use with aggressive dogs. Do not use this Product if your dog is aggressive, or if your dog is prone to aggressive behavior. Aggressive dogs can cause severe injury and even death to their owner and others. If you are unsure whether this product is appropriate for your dog, please consult your veterinarian or certified trainer.

- ◆ For use with dogs over 6 months of age and over 5 lbs.
- ◆ DO NOT use when the dog or the collar is/are wet.
- ◆ DO NOT press and hold shock or vibrate for more than 10 seconds to avoid physical or psychological damage to your dog.
- ◆ Your dog should not vocalize or panic when receiving stimulation. If this happens, the stimulation level is too high and you need to go back to the previous level and repeat the process.
- ◆ DO NOT charge the device near any flammable substances.
- ◆ For dog use only. Not for use on children.
- ◆ This is not a toy, and should only be operated by responsible adult.

### CAUTION

For on leash training. Do not attach leash to training collar. Use a regular collar in addition to the training collar. Risk of skin damage. Please read and follow the instructions in this manual. Proper fit of the collar is important. A collar worn for too long or made too tight on the dog's neck may cause skin damage. Ranging from redness to pressure ulcers; this condition is commonly known as bed sores.

- ◆ Do NOT leave the collar on the dog for more than 12 hours per day.
- ◆ When possible re-position the collar on the dog's neck every 1 to 2 hours.
- ◆ Check the fit to prevent excessive pressure; follow the instructions in this manual.
- ◆ Never connect a lead to the collar; it will cause excessive pressure on the contacts.
- ◆ Wash the dog's neck area and the contact probes of the collar weekly with a damp cloth.
- ◆ Examine the contact area daily for signs of a rash or a sore.
- ◆ If a rash or sore is found, discontinue use of the collar until the skin has healed. If the condition persists beyond 48 hours, see your veterinarian.
- ◆ Receiver collar meets IP67 water proof rating, it can be submerged into water up to 1 meter for up to 30 minutes. If submerged and wet, please do not use.
- ◆ This product comes with conductive silicone covers, please ensure they are worn on the contact points before putting the receiver on your dog and check for the presence of the silicone cover every hour.

# I. Package Content



Remote Transmitter



Receiver

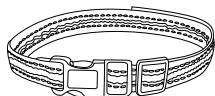

Collar

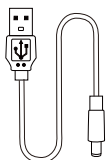

Charging Cable

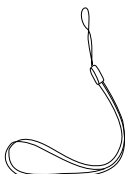

Wrist Lanyard



User Manual



Test Bulb Tool



Metal Prongs



Silicone Caps

# II. Product Overview

## Receiver

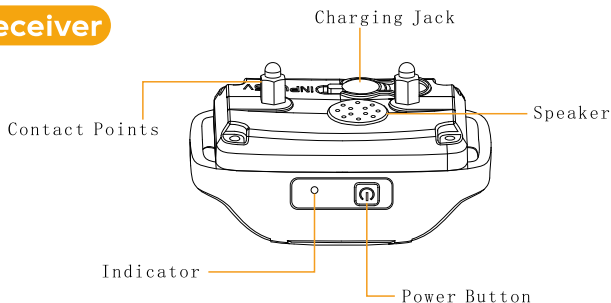



## How the System Works

The Remote Training Collar is easy to use with an advanced digital display that tells you exactly what level of stimulation you are using.

The Remote Training Collar assists you in controlling your dog without a leash.

At the push of a button, your remote sends a signal activating your dog's Receiver. He receives a safe but annoying stimulation. He'll quickly learn the association between his behavior and your correction; in no time, you'll have a better-behaved dog. The Remote Training Collar has been proven safe, comfortable, and effective for both small and large dog breeds.

Using the Remote Training Collar consistently and correctly, any basic obedience commands can be taught and will help to correct many misbehavior that your dog exhibits.

## Remote Transmitter

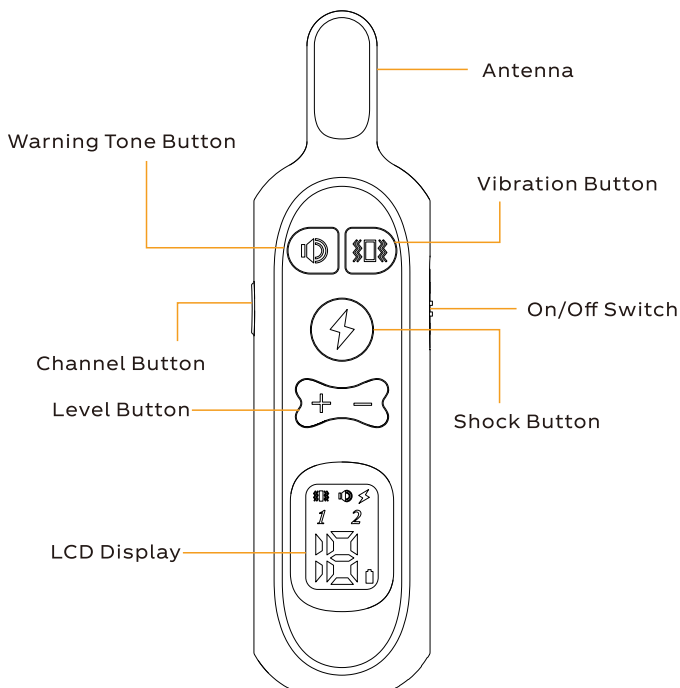

## Screen

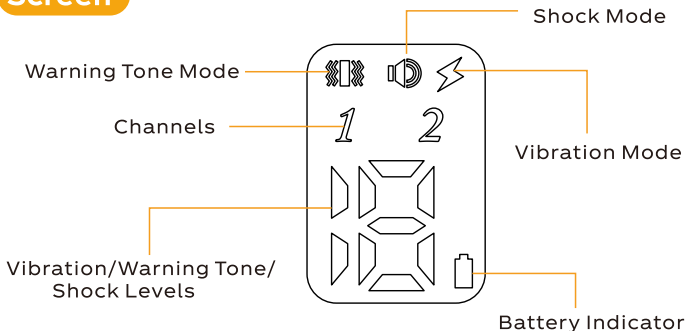

## III. Setting Up

### 1. Charge the Product

**Remote Transmitter:** replace the the Aklaine batteries in remote if the battery indicator blinks on the screen.

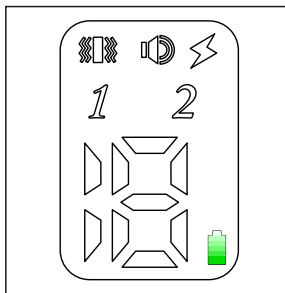
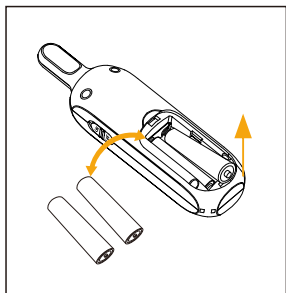

**Receiver:** charge the device until the indicator becomes solid green which will take around 2-3 hours.

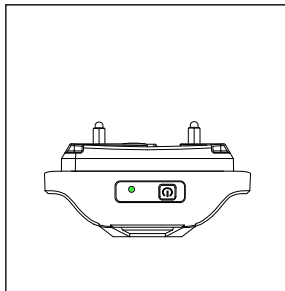
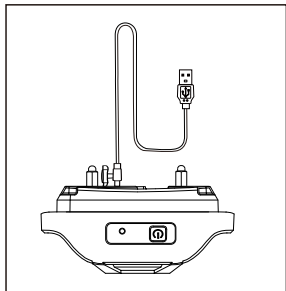

## 2. Turn On/Off the Product

Turn on the Remote Transmitter by Toggle the Power Button up to turn on the Remote Transmitter.

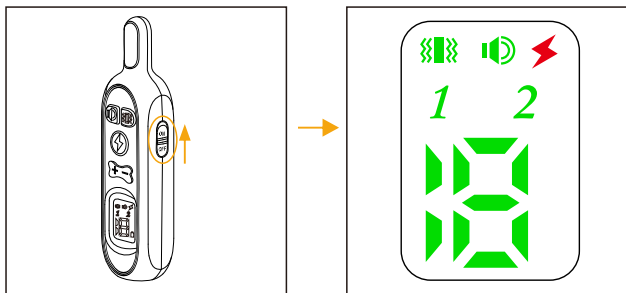

Turn on the Receiver by pressing and holding the Power Button for 2 seconds.

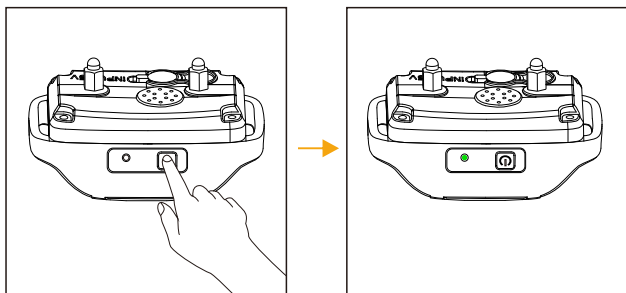

## IV. Training Modes

### 1. Warning Tone Mode

Press the Warning Tone button and Receiver will deliver a warning tone. It will cut off automatically if you press and hold the Warning Tone button for 10 seconds. There are total 8 levels of Warning Tone for training which you can adjust by the Level Button.

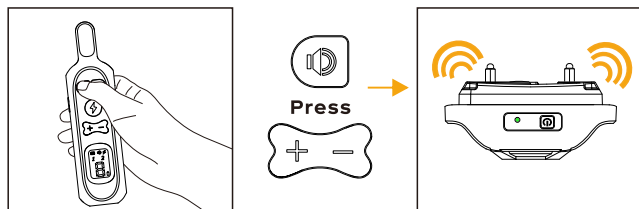

## 2.Vibration Mode

Press the Vibration button and Receiver will deliver a vibration. It will cut off automatically if you press and hold the Vibration button for 10 seconds. There are total 16 levels of Vibration for training which you can adjust by the Level Button.

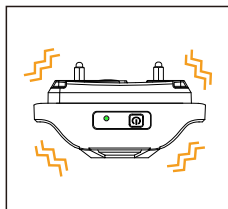
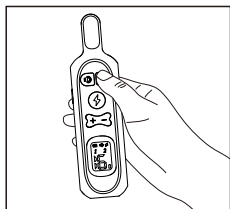

## 3.Shock Mode

Press the Shock button and Receiver will deliver a static shock. It will cut off automatically if you press and hold the Shock button for 10 seconds. There are total 18 levels of Static Shock for training which you can adjust by the Level Button.

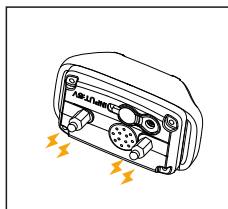
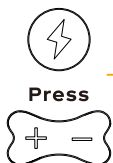
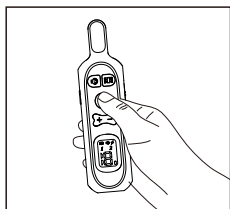

## 4.Switching Channels

Press the Channel button to chose the Receiver you want to control if you have paired up two Receivers.

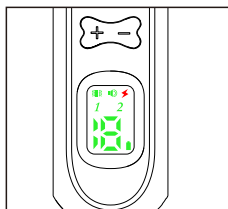
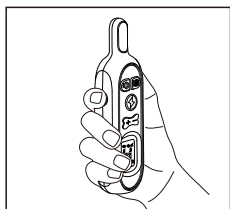

## V. Fitting the Receiver

### Important:

The proper fit and placement of your Receiver is important for effective training. The Contact Points with Conductive Silicone Cover must have direct contact with your dog's skin on the underside of his neck. To assure a proper fit, please follow these steps:

1. Make sure that the Receiver is turned off.
2. Have your dog standing comfortably (A).
3. Place the Receiver on your dog's neck close to the ears. Center the Contact Points underneath your dog's neck, touching the skin. Note: It is sometimes necessary to trim the hair around the Contact Points to make sure that contact is consistent.
4. The Receiver should fit snugly, yet loose enough to allow one finger to fit between the strap and your dog's neck (C).
5. Allow your dog to wear the collar for several minutes then recheck the fit. Check the fit again as your dog becomes more comfortable with the Receiver.



### 6. How to attach the collar to the Receiver ?

Follow the 1-2-3-4 steps instructed to the thread the strap.

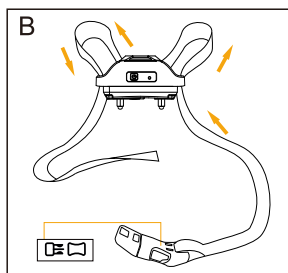
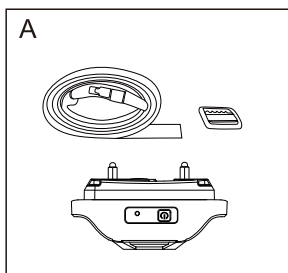

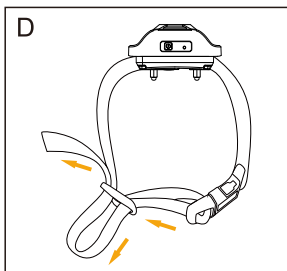
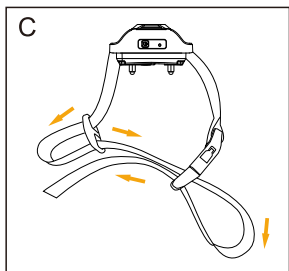

## CAUTION:

**Risk of Skin Damage.** Too long time or too tight fitting may cause pressure necroses, which if often misidentified as burns. Please follow below instructions:

- Do not shave the dog's neck as this may increase the risk of skin irritation.
- Do not leave the Receiver on your dog's neck for continuous 12 hours.
- Never attach leash to the collar.
- Never fit the Receiver too tight to your dog's neck.

## VI. Pairing Up

If you feel the Receiver is not responding to the Remote Transmitter, follow these steps to pair them up.

1. Press and hold the power button on the Receiver for 2 seconds to turn it on and toggle up the On/Off button to turn the Remote Transmitter on.

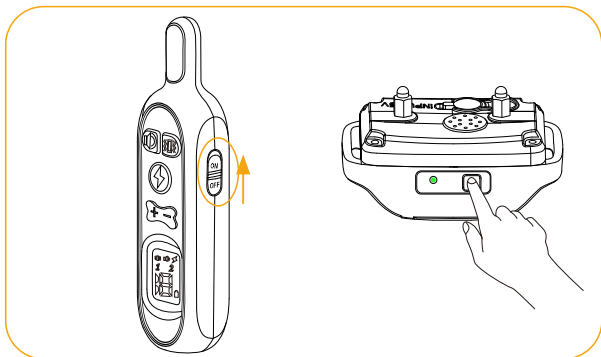

2. Press the power button on Receiver 3 times to enter the pairing mode. You will hear a Warning Tone and the indicator become solid. You will now have 10 seconds to finish the pairing.

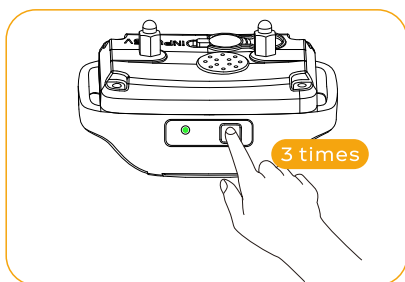

3. Press the Warning Tone button, Vibration button or Shock button on the Remote Transmitter, and Receiver will respond correspondingly indicating that pairing process is completed.

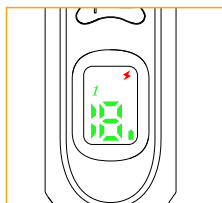
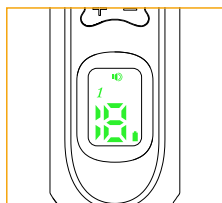
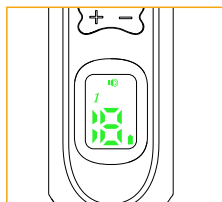

## Tips:







The Receiver is paired up to Remote Transmitter in Channel 1 by factory default setting,

If you buy a new Receiver, you follow above pairing instruction to pair up to channel 2. The system can pair up to 2 Receiver in 2 different channels.

If you can not pair the device successfully, it maybe caused by the signal interference. Please try in a new place or contact with our service center.

## LCD Display & Indicator Definitions

### Remote:

	Warning Tone mode
	Vibration mode
	Shock mode
	Channel 1 and 2
	Levels for Warning Tone/Vibration/Shock
	Slow blinks indicates Remote Transmitter battery is low

### Receiver:

	Receiver Blinking indicates Receiver is on; fast blinking indicates Receiver battery is low
--	---

## Training Tip

### How find the best stimulation for your dog?

Important: Always start at the lowest level and work your way up. The Remote Training Collar has 8 types Warning Tone, 16 levels for Vibration and 18 levels for Static Shock. For Warning Tone, there are 8 types of tones and there is only frequency difference among different types. For Vibration and Static Shock, level 1 is the lowest; level 16 is the highest for Vibration and 18 for static shock.



This allows you to choose the Stimulation level that is best for your dog. Once you have placed the Receiver on your dog, it is time to find the Stimulation Level that is best for him. This is called the Recognition Level. A slight change in your dog's behavior, such as looking around in curiosity, scratching at his collar, or flicking his ears, indicates the Recognition Level that is best for your dog.

### Follow the steps below to find your dog's Recognition Level:

1. Starting at Level 1, press the Warning Tone/Vibration/Shock Button continuously for 1 to 2 seconds. Note: When the Warning Tone/Vibration/Shock Button is held down for 10 consecutive seconds, the Remote Transmitter will "time-out", and you must release and press the button again before additional stimulation can be delivered.
  2. If your dog shows no reaction, repeat the Stimulation Level several times before moving up to the next level.
  3. YOUR DOG SHOULD NOT VOCALIZE OR PANIC WHEN RECEIVING STIMULATION. IF THIS HAPPENS, THE STIMULATION LEVEL IS TOO HIGH AND YOU NEED TO GO BACK TO THE PREVIOUS LEVEL AND REPEAT THE PROCESS.
  4. Move up through the Stimulation Levels until your dog reliably responds to the stimulation.
  5. If your dog continues to show no response at highest level of Vibration or Static Shock, check the fit of the Receiver. If your dog has long or thick hair, contact our Customer Care Center to obtain a longer set of Contact Points. Then go back to #1 and repeat the process. If this still does not yield any results, your dog's hair will need to be trimmed around the Contact Points.
- If, after completing all of these steps, your dog still does not indicate he is feeling the stimulation, please contact our customer service.

### How to Maximize the distance?

Terrain, weather, vegetation, transmission from other radio devices, and other factors will affect the maximum range.

Hold the Remote Transmitter in a horizontal position away from your body to achieve optimum range. For Maximum signal strength, keep the device properly charged.

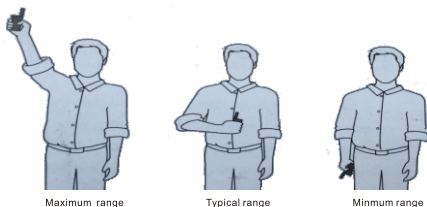

\*Avoid touching the antenna or the range may decrease substantially.

## Frequently Asked Questions

### **Q: Is the Stimulation safe for my dog?**

A: While the Stimulation is unpleasant, it is harmless to your dog. Electronic training devices require interaction and training from the owner to achieve desired results.

### **Q: How old does my dog have to be before using the Remote Training Collar?**

A: Your dog should be able to recognize basic obedience commands such as "Sit" or "Stay". Dogs should be at least 6 months old before using the Trainer.

### **Q: Once my dog is trained and has been obeying my commands, will he have to continue to wear the Receiver?**

A: Probably not. You may need to reinforce training with the Receiver from time to time.

### **Q: Is the Receiver waterproof?**

A: Yes. Receiver meets IP67 waterproof rating, but make sure to keep the area dry when charging. Note: Remote Transmitter is not waterproof.

### **Q: Will I get maximum range with the Remote Training Collar?**

A: The range of the Remote Training Collar will vary according to terrain, weather, vegetation, as well as transmission from other radio devices.

See "How the System Works" for tips on maximizing your range.

### **Q: How long can I continuously deliver stimulation to my dog?**

A: The maximum amount of time you can press the Warning Tone/Vibration/Shock button and deliver stimulation to your dog continuously is 10 seconds. After this, the Remote Transmitter will time-out, and these stimulation buttons must be released and pressed again.