

HONDA CB125R '18- / CB300R '18-









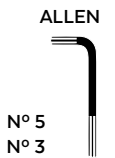

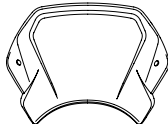

REF 9802

**ALUMINUM
FRONT PLATE**

REF 9663

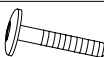
**ABS
FRONT PLATE**

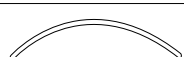

| ID. | PIEZA / PART | DESCRIPCIÓN | DESCRIPTION | QTY. | REF.: |
|-----|---|--|---|------|-----------------|
| 1 |  | Placa frontal ABS | ABS front plate | 1 | 10526J/C |
| |  | Placa frontal ALUMINIO | ALUMINUM front plate | | 9807P/N |
| 2 |  | Soporte metálico derecho | Right metal support | 1 | SOPOR-2P-3-9663 |
| 3 |  | Soporte metálico izquierdo | Left metal support | 1 | SOPOR-2P-3-9663 |
| 4 |  | Silentblock M5 | M5 silentblock | 2 | SILENBTM5-046/1 |
| 5 |  | Tornillo allen M5x16 Ø11 ISO7380 | M5x16 Ø 11 ISO7380 allen screw | 2 | TORNI-I7380-493 |
| 6 |  | Tornillo allen M5x16 Ø11 ISO 7380 (INOX) | M5x16 Ø11 ISO 7380 allen screw (INOX) | 2 | TORNI-IA----423 |
| 7 |  | Arandela nylon M5x1 | M5x1 nylon washer | 2 | ARNV0000000245 |
| 8 |  | Tapón tornillo M5 ISO7380 | M5 ISO7380 allen screw cap | 2 | TAPON-----85 |
| 9 |  | Tornillo allen M5x40 Ø11 ISO7380 | M5x40 ISO7380 allen screw | 2 | TORNI-I7380-774 |
| 10 |  | Casquillo Ø8,5xØ14x22 | Ø8,5xØ14x22 arrowhead | 2 | CASQUI-----150 |
| 11 |  | Separador de silicona Ø8x2 (Se suministra montado en ID2 y ID3) | Ø8x2 mm silicone tear (Supplied already mounted on item ID2 & ID3) | 4 | ADHESI-GT-D8--- |
| 12 |  | Ribete autoadhesivo longitud de 190mm 6,2mmx2,6mm | Selft-autoadhesive trim lenght 190mm 6,2x2,6mm | 4 | RIBETETP---0900 |
| 13 |  | Kit adhesivos https://www.youtube.com/watch?v=IxEcdLZ58qg | Stickers set https://www.youtube.com/watch?v=IxEcdLZ58qg | 1 | 10535 |

HONDA CB125R '18- / CB300R '18-

INSTRUCCIONES DE MONTAJE - MOUNTING INSTRUCTIONS - MONTAGEANLEITUNG

1

**DISASSEMBLY
DESMONTAJE**

A Tornillería original
Original screws

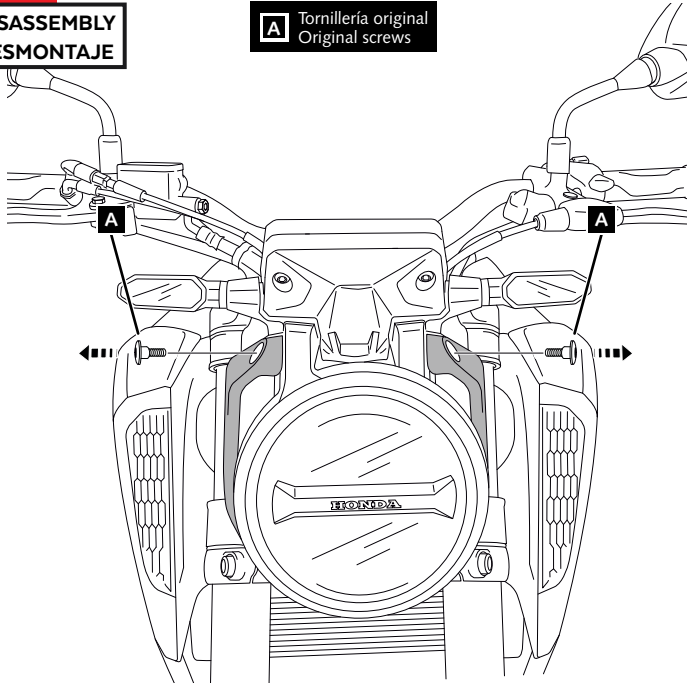

2

**ASSEMBLY
MONTAJE**

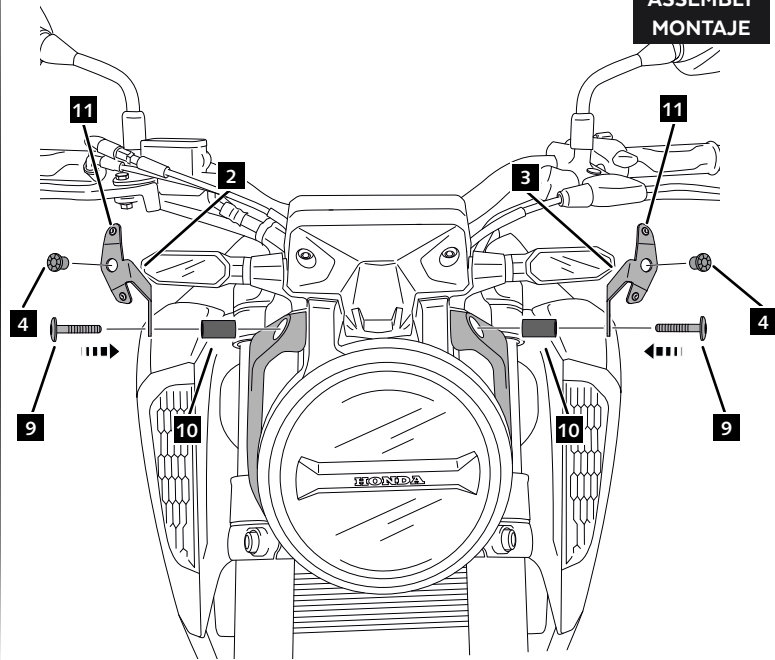

3

ALUMINUM

**ASSEMBLY
MONTAJE**

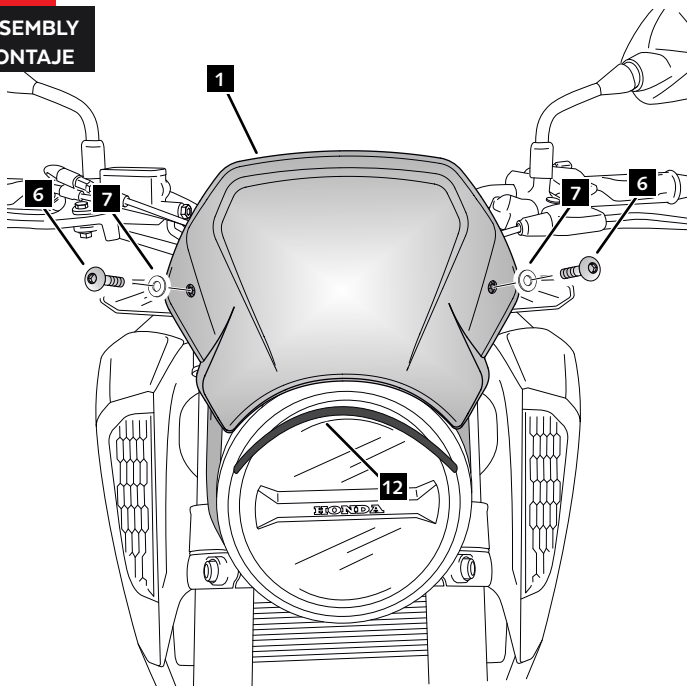

ABS

