

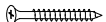

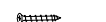

Part	Description	Qty
A	Right armrest	1
B	Left armrest	1
C	Back side	1
D	Front side	1
E	Seat part	1
1	 5 x 90 mm	8
2	 3,5 x 35 mm	10
3		2
4	 45 x 20 x 5 mm	4
5	 3 x 20 mm	8