



FDP 200805-E

---

|                  |          |
|------------------|----------|
| English .....    | 5 - 20   |
| Čeština .....    | 21 - 36  |
| Slovenčina ..... | 37 - 52  |
| Magyarul .....   | 53 - 68  |
| Polski .....     | 69 - 84  |
| Русский .....    | 85 - 101 |

1

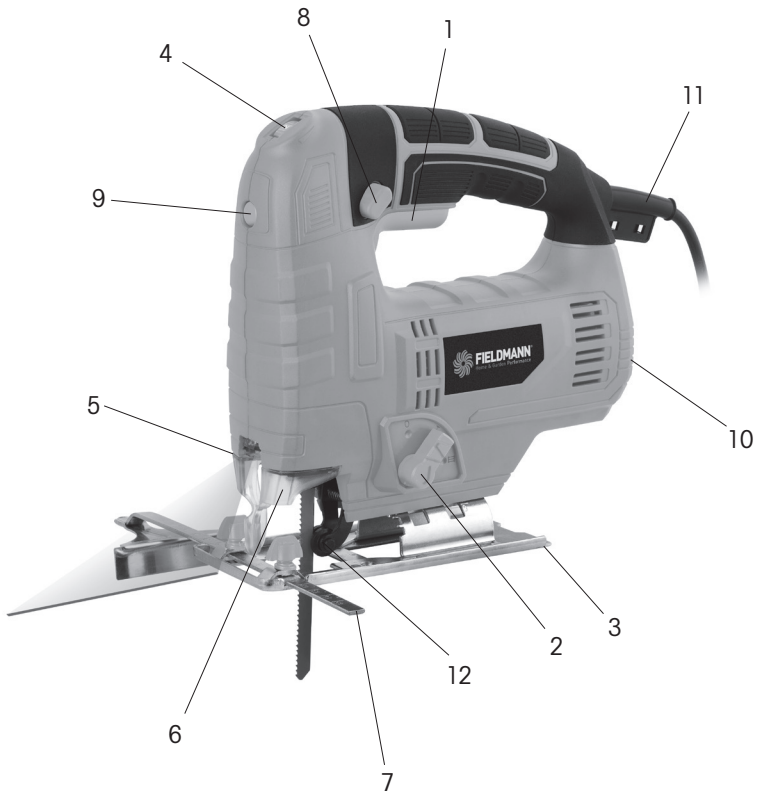



# Electrical Jig Saw

## INSTRUCTION MANUAL

**Thank you for your purchase of the electrical jig saw. For your personal safety, read and understand the Instruction Manual before using. Keep the Instruction Manual in a safe place for future reference.**



### CONTENTS

|  |    |
|--|----|
| PICTORIAL APPENDIX .....                         | 3  |
| 1. GENERAL SAFETY INSTRUCTIONS .....             | 6  |
| Important Safety Instructions                    |    |
| Package  |    |
| Instruction Manual                               |    |
| 2. SYMBOLS .....                                 | 7  |
| 3. MACHINE DESCRIPTION AND ITEMS DELIVERED ..... | 8  |
| 4. GENERAL SAFETY INSTRUCTIONS.....              | 8  |
| 5. SPECIFIC SAFETY INSTRUCTIONS.....             | 12 |
| 6. HEARING PROTECTION .....                      | 13 |
| 7. OPERATION .....                               | 13 |
| 8. MACHINE CARE.....                             | 16 |
| 9. WARRANTY.....                                 | 16 |
| 10. DECLARATION OF CONFORMIT .....               | 17 |
| 11. TECHNICAL SPECIFICATIONS .....               | 18 |
| 12. DISPOSAL .....                               | 19 |

# 1. GENERAL SAFETY INSTRUCTIONS

 **WARNING!** Carefully read the instruction manual before use.

## Important safety warnings

-  Unpack the product carefully and be sure not to throw away any part of the package before having found all components of the product.
-  Keep the product in a dry place out of reach of children.
-  Read all cautions and instructions. The failure to adhere to warning cautions and instructions may result in an accident, fire and/or a serious injury.

## Packaging

The product is placed in a package preventing damage during transport. This package is a raw material therefore it can be handed-over for recycling.

## Instructions for use

Before beginning to work with the machine, read the following safety rules and instructions for use. Familiarize with operating elements and the proper use of the device. Keep the manual in a safe place for future reference. We recommend keeping the original package including the inner packaging materials, cash voucher and guarantee card for a period of warranty at minimum. For a case of transportation, pack the machine into the original box from the manufacturer, thus ensuring a maximum protection of the product during a possible transport (e.g. moving or sending into a service station).

 **Note:** If you hand the machine over to next persons, hand it over together with the manual. Adherence to the attached instructions for use is a precondition for the proper use of the machine. The operation manual includes also instructions for operation, maintenance and repairs.

**The manufacturer does not take any responsibility for accidents or damages resulting from the failure to adhere to this manual.**

## 2. SYMBOLS

|   |   |
|---|---|
|    | The product complies with the applicable standards and regulations. |
|    | Read the Instruction Manual attentively prior to use.               |
|    | Double-insulated.   |
|   | Use eyes protective equipment                                       |
|  | Use ears protective equipment                                       |
|  | Subjected to recycling  |
|  |   |

## 3. MACHINE DESCRIPTION AND ITEMS DELIVERED

### Machine Description (See fig. 1)

- |                                |                           |
|--------------------------------|---------------------------|
| 1 - ON/OFF switch              | 7 - Guide                 |
| 2 - Pendulum action controller | 8 - Switch locking button |
| 3 - Base plate                 | 9 - Laser beam switch     |
| 4 - Speed controller           | 10 - Hoover connection    |
| 5 - Laser beam                 | 11 - Power cable          |
| 6 - Safeguard                  | 12 - Saw blade holder     |

### Items Delivered

Remove all contents from the box and inspect to ensure no damage was incurred during shipping, and that the items listed below are included.

- ✿ Jig saw
- ✿ Parallel edge guide
- ✿ 2 saw blade
- ✿ Warranty card
- ✿ Instruction Manual

Should the components be missing or damaged, contact the dealer of the machine.

## 4. GENERAL SAFETY INSTRUCTIONS

**Please read these safety instructions carefully, remember them and keep them in a safe place**

**⚠ WARNING!** When using electric machinery and power tools, it is important to abide by and adhere to the following safety instructions for reasons of protection against injury caused by electric current, injury of persons and risk of starting fires. The term "power tools" used in the instructions below refers to power tools that are plugged into a power supply (by a power cord) as well as tools running on a battery pack (cordless). Keep all warnings and instructions for further use.

### Work environment

- ✿ Keep the work area clean and well lit. Untidiness and dark places on the job site are usually causes of accidents. Store tools that are not used.



- ✿ Do not use power tools in an environment where there is risk of starting a fire or explosion; this refers to places where there are flammable liquids, gases or dust. Sparks form on the power tool's commutator, which can cause dust or fume ignition.
- ✿ When using power tools, unauthorized persons, especially children, should be denied entry to the job site! In case you are interrupted, you can lose control of the current activity. In any case, do not leave the power tool without supervision. Prevent animals from approaching the equipment.

## Electrical safety

- ✿ The power tool's power plug must correspond to the power outlet. Never alter the plug in any way. If the tool's plug has a safety peg, never use an adapter of any kind. Undamaged plugs and corresponding outlets prevent the risk of injury by electric current. If the power cord is damaged, it must be replaced by a new power cord that can be obtained from an authorized service centre or the importer.
- ✿ Avoid bodily contact with grounded items, e.g. piping, radiators, kitchen ranges and refrigerators. The risk of injury by electric current is greater if your body is connected to the ground.
- ✿ Do not expose power tools to rain, moisture or dampness. Never touch power tools with wet hands. Never wash power tools with running water and never submerge them into water.
- ✿ Do not use the power cord for any other purpose than originally intended. Never carry or pull the power tools by the power cord. Do not pull the plug out of the outlet by pulling on the cord. Avoid mechanical damage to the power cord by sharp or hot objects.
- ✿ Power tools were manufactured exclusively for the AC power supply. Always check if the electrical voltage corresponds to the data printed on the tool's serial number label.
- ✿ Never work with a tool that has a damaged power cord or plug, or that has fallen on the ground and is damaged in any way.
- ✿ In the case of using an extension cord, always check that its technical parameters correspond to the data printed on the tool's serial number label. If the power tool is used outdoors, use an extension cord that is appropriate for exterior use. When using an extension cable drum, the cord must be unwound to prevent the cord from overheating.
- ✿ If the power tool is used in moist areas or outdoors, it is permitted to use it only if it is plugged into an electric circuit with a residual current device  $\leq 30$  mA. Using a circuit with an RCD lowers the risk of injury by electric current.
- ✿ Grasp hand power tools at the designated isolated grip areas because, during operation, one may come into contact with the cutting or drilling fittings with a hidden conductor or with the power cord.

## Personal safety

- ✿ When using a power tool, be careful and alert, pay special attention to the activity you are doing. Concentrate on your work. Do not work with power tools if you are tired or if you are under the influence of drugs, alcohol or medication. When using power tools, even a momentary lapse in attentiveness can lead to severe personal injury. Do not eat, drink or smoke while working with power tools.
- ✿ Use protective gear. Always use eye protection. Use protective gear corresponding to the type of work you are doing. Protective gear such as respirators, safety shoes with antiskid treatment, head protection or ear protection, used in accordance with working conditions, lower the risk of personal injury.
- ✿ Avoid unintentional operation of tools. Do not carry tools that are plugged into the electric grid with your finger on the switch or release trigger. Before connecting the tool to a power supply, make sure that the switch or release trigger are in the "off" position. Carrying tools with your finger on the switch or plugging the tool into an outlet with the switch in the "on" position can cause serious injury.
- ✿ Before turning tools on, remove all adjustment wrenches and tools. The adjustment wrench or tool that stays connected to the rotating part of the power tool can cause personal injury.
- ✿ Always stand firmly and keep your balance. Work only in places that you can reach safely. Never overestimate your own strength. Do not use power tools if you are tired.
- ✿ Dress appropriately. Use working clothes. Do not wear loose clothing or jewellery. Make sure that your hair, clothing, gloves or other body parts do not come overly close to rotating or heated parts of the power tool.
- ✿ Connect the equipment to the dust exhaust. If the tool offers the possibility to connect equipment for capturing dust or dust suction, make sure that it is properly connected and used. Using this equipment can reduce danger resulting from dust.
- ✿ Firmly fasten the workpiece. Use a carpenter's clamp or vice to secure the piece you will be cutting.
- ✿ Do not use power tools if you are under the influence of alcohol, drugs, medication or other narcotics or addictive substances.
- ✿ This equipment is not intended to be used by persons with limited physical, sensory or mental abilities (including children) or persons with insufficient experience and knowledge, unless they are supervised or received instructions to use the equipment from a person responsible for his/her safety. Children must be supervised in order to ensure that they are not playing with the equipment.

## Using power tools and their maintenance

- ✿ Always disconnect the power tool from the electric grid if there is any problem during work, before every cleaning or maintenance, during every shift and after finishing work! Never work with power tools if they are damaged in any way.
- ✿ If the tool starts emitting abnormal noises or odours, immediately stop working.

- ✿ Do not overload power tools. The power tool will function better and more safely if it operates at speeds for which it was designed. Use correct tools that are designated for the given activity. The correct tool works better and more safely.
- ✿ Do not use power tools that cannot be turned on safely and cannot be turned on and off with a control switch. Using this type of tool is dangerous. Faulty switches must be repaired at a certified service centre.
- ✿ Disconnect the tool from the power supply before you start setting, changing accessories or maintenance. This measure will prevent the risk of accidental start-up.
- ✿ Store unused power tools so that they are out of the reach of children and unauthorized persons. Power tools in the hands of inexperienced users can be dangerous. Store power tools in a dry and safe place.
- ✿ Keep power tools in good condition. Regularly check the setting of moving parts and their movability. Check if the protective cover or other parts that can limit the safe functioning of the power tool are not damaged. If the tool is damaged, ensure its proper repair before the next use. Many injuries are caused by poorly maintained power tools.
- ✿ Keep cutting tools sharp and clean. Properly maintained and sharpened tools make work easier, limit the risk of injury and work with them is much more easily controlled. Using other accessories than those listed in the instruction manual can cause damage to the tool and can cause injury.
- ✿ Use power tools, accessories, work tools, etc. in accordance with these instructions and in a way that is described for the specific power tool and with regard to the given working conditions and the type of job. Using tools for other purposes than those intended can lead to dangerous situations.

### Using cordless tools

- ✿ Before inserting the battery, make sure that the switch is in the "O-off" position. Inserting the battery into a running tool can cause dangerous situations.
- ✿ To charge the battery, only use chargers that are specified by the manufacturer. Using a charger for a different kind of battery can cause damage to the battery and result in fire.
- ✿ Only use batteries that are designated for the given tool. Using other batteries can cause injury or result in fire.
- ✿ If the battery is not used, store it away from metal objects such as clamps, wrenches, screws and other small metal objects that could cause the connection of one battery contact with the other. Short-circuiting the battery can cause injury, burns or fire.
- ✿ Handle batteries with care. In the case of improper care, chemical substances can leak from the battery. Avoid coming into contact with this substance and if you do come into contact with it, rinse the affected area under running water. If the chemical substance comes into contact with the eye, immediately seek out medical attention. The chemical substance from the battery can cause serious injury.

## Service

- ✿ Do not change parts of the tool, do not perform repairs on your own and do not interfere with the tool's construction in any way. Leave tool repairs to qualified persons.
- ✿ Each repair or product modification performed without our company's permission is inadmissible (it can cause injury or harm to the user).
- ✿ Always leave tools to be repaired in a certified service centre. Use only original or recommended spare parts. This will ensure your and your tool's safety.

# 5. SPECIFIC SAFETY INSTRUCTIONS

**⚠ WARNING!** Before use, please read these safety Instructions and store them with care.

- ✿ Please ensure that the voltage of the mains power supply corresponds to the value stated on the type plate. The tool is equipped with a two-pole lead and plug!
- ✿ Wear safety glasses and a face or dust mask if the cutting or drilling operation is dusty. When using the tool for extended periods, or where the noise level is high, use adequate hearing protection.
- ✿ If devices are provided for the connection of dust extraction and collection facilities, ensure these are connected and properly used. Always empty the dust collection bag when full.
- ✿ Use clamps or a vice to hold the work piece. It is safer than using your hand and frees both hands to operate the tool.
- ✿ Ensure the power cord is arranged so that it cannot be tripped over, stepped on or have heavy weights rested on it; and make sure that the cord will not be subjected to any damage.
- ✿ A risk of injury exists in the case that instructions in this manual are not followed.
- ✿ The jigsaw complies with valid technical regulations and norms.
- ✿ When working with the jigsaw, the protective cover must always be pushed down.
- ✿ Regularly check both screws on the clamp of the saw blade.
- ✿ Do not use damaged or worn saw blades.
- ✿ Regularly check the setting of the guide pulley.
- ✿ Do not turn the saw on if the saw blade slid into the workpiece.
- ✿ Never overload the saw so much that the engine ceases.
- ✿ Never try to stop the movement of the saw blade, even when the engine is turned off.
- ✿ The saw blade itself is removed very quickly. The blade's teeth are very sharp.
- ✿ Never aim the saw at another person.
- ✿ Use protective gear against noise, dust and vibrations!!!

**⚠ WARNING!** Keep these safety instructions!!!

## 6. HEARING PROTECTION

**⚠ WARNING!** In case the sound pressure level exceeds the value of 85.0 dB(A), wear adequate hearing protection to avoid damage to your hearing!

## 7. OPERATION

### Laser beam adjustment

Transport, handling and heavy use can affect the precision of the laser beam. The laser beam itself can be easily adjusted.

- ✿ Loosen the lower Philips screws on the front or at the side of the machine by a few turns.
- ✿ Hold the jig saw, fitted with a saw blade, against a straightedge or perfectly straight plank.
- ✿ Check whether the laser beam runs dead straight along the edge of the straightedge or plank.
- ✿ If this is not case, then adjust the laser beam by slightly turning the laser holder.
- ✿ Once the correct adjustment has been made, retighten the Philips screws.

 **Note:** When sawing a bevel, the cut will no longer be aligned with the notch in the sole plate.

 **Note:** Whatever the bevel angle, the saw cut will always follow the laser beam.

### Working with a jig saw

**⚠ WARNING!** The saw is exclusively dedicated to home or hobby use. The manufacturer and importer do not recommend using this tool in extreme conditions and excessive loads. Any kind of further requests must be the subject of agreement between the manufacturer and customer.

- ✿ The tool is an electronic speed controlled, pendulum action jig saw. The adjustable speed and 3-stage pendulum action gives an enhanced cutting performance and optimum curve-cutting action, saving the blade from wear. Before using the jig saw, read the instructions thoroughly and acquaint yourselves with its features.
- ✿ Make sure that the working area is clear of all obstacles particularly on the reverse side of the cut. If you use the saw with one hand always ensure your free hand is away from the cutting area.

 **Note:** It is recommended that the mains plug is removed from any socket or extension lead prior to ANY adjustment or service being undertaken to avoid accidental start up of the product.

## Saw blade replacement

**⚠ WARNING!** Turn off the jig saw and unplug the power supply cable from the socket.

- ✿ Select a saw blade as applicable for the material to be cut.
- ✿ Lift the plastic transparent cover, turn the keyless chuck to the right, insert the blade all the way (teeth facing you) and release the keyless chuck.
- ✿ Insert the blade into the blade holder, ensuring that the teeth are pointing forward and the flat back edge of the blade locates in the guide roller.
- ✿ Close the protective plastic transparent cover.
- ✿ Check the blade is correctly positioned in the guide roller and that it is secure in the blade holder.

## Dust exhaust

Insert the extraction nozzle into the dust extraction opening at the rear of the saw and twist anticlockwise to secure. (Clockwise to remove.) Attach a standard vacuum cleaner hose and let the vacuum collect the dust as you saw. Always use a face mask, even when using the vacuum extraction system.

## Pendulum action control

- ✿ The pendulum stroke action can be adjusted using the pendulum knob located on the left hand side of the jig saw, near the blade.
- ✿ There are four marked settings: 0, 1, 2 and 3
- ✿ Indications of the best pendulum stroke setting for a particular job are given below:

|             |     |
|-------------|-----|
| Sheet metal | 0   |
| Steel       | 0   |
| Plywood     | 2-3 |
| Aluminium   | 0   |
| Plastics    | 1-2 |
| Wood        | 2-3 |

## Angle sawing

- ✿ The jig saw can be used to cut at various angles by adjusting the base plate.
- ✿ Before adjusting the base plate, ensure that the jig saw is unplugged from the mains.
- ✿ To adjust the base plate, loosen the hexagon bolt on the underside of the jig saw using the hexagon key.
- ✿ Slide the base plate forwards, incline it at the desired angle (range: 15°, 30°, 45°)
- ✿ Tighten the hexagon bolt using the hexagon key.
- ✿ Operate the same way as for straight cutting, ensuring that the base plate is firmly held flat against the work piece.

## Straight cutting

- ✿ Ensure the work piece is firmly secured in a vice or workbench.
- ✿ Mark a line on the work piece through which the cut is required.
- ✿ Start up the jig saw and place the front of the base plate onto the work piece.
- ✿ Align the blade with the cutting mark on the work piece.
- ✿ Slowly move the jig saw forward along the cutting mark. Press the jig saw down firmly onto the work piece to prevent the blade from snagging or breaking.
- ✿ Allow the tool to work at its own pace, letting the blade cut freely - do not force the tool. Increasing pressure will not result in a faster cut.
- ✿ Choose an appropriate blade according to the required job and finish, depending on the type and thickness of the material. Large teeth will give a quick, coarse cut and small teeth will produce a quality finish.
- ✿ When cutting thin board, place it on a wood board to help absorb vibrations

## ON/OFF switch

- ✿ The on/off switch (1) is located in the saw handle.
- ✿ Depress the trigger switch to turn on the jig saw.
- ✿ The on/off switch can be locked with the locking button on the side of the saw handle.
- ✿ To unlock the switch, depress the switch button again. Always ensure that the switch is in the off position before connecting the tool to the mains. Always disconnect the tool from the mains when not in use.

## Speed control

- ✿ The speed of the machine can be adjusted by operating the speed control wheel on the front of handle.
- ✿ To increase the speed, turn the wheel forward, and to decrease the speed, turn the wheel backwards.

## Cleaning and Storing Instructions

- ⚠ **WARNING!** Prior to maintenance and cleaning, ensure the power is disconnected from the saw. Unplug the power cable from the power supply network. Use only mild soap and a slightly damp cloth to clean your saw. Many household cleaners contain chemicals which could seriously damage the plastic. Do not use petrol, turpentine, lacquer or paint thinners or similar products to clean the machine. Never let any liquid get inside the tool and never immerse any part of your saw into liquid.
- ✿ Never use water or other liquids to clean the electrical parts of the tool.
- ✿ Always clean the tool after use.
- ✿ Ensure the ventilation slots do not become blocked to prevent overheating.

- ✿ Check the carbon brushes regularly (dirty or worn carbon brushes result in excessive sparking and speed faults).
- ✿ Always replace the carbon brushes in pairs.

## 8. MACHINE CARE

### Overload

Never use excessive force when cutting. Too much pressure reduces the speed of the machine, and the required power is greatly reduced. This may result in overload which can damage the motor of the machine. When the machine becomes too hot, allow it to run for two minutes at no load and then interrupt working for a short time. Clean the machine with a clean cloth and a brush. Ensure that the ventilation slots are not blocked.

## 9. WARRANTY

The Warranty Card shall be valid only when submitted together with the purchase receipt. Keep the both documents in a safe place. To lodge a warranty complaint, turn to your dealer or a service centre. The warranty shall apply to all product defects and faults that occurred during the warranty period and were demonstrably attributable to material or manufacturing defects. In such cases the product shall be repaired and/or adjusted. The warranty shall not apply to standard wear of the product, as well as to faults attributable to overloading, using of inappropriate accessories or improper operation of the product.



# 10. DECLARATION OF CONFORMITY



**FAST ČR, a.s.**  
Černokostecká 1621, 251 01 Říčany, Czech Republic  
tel.: +420 323 204 111, fax: +420 323 204 110

## EU DECLARATION OF CONFORMITY

**Product / brand:** Hand-held Jig Saw / **FIELDMANN**

**Type / model:** **FDP 200805-E** as factory model M1Q-DD20-80  
AC 230V, 50Hz, 800W, 0-2800/m<sup>3</sup>, Class II, IP20, LED light,  
Laser Class II  
L<sub>PA</sub> = 86dB(A), L<sub>WA</sub> = 97dB(A)

**Manufacturer:** FAST ČR, a.s.  
Černokostecká 2111, 100 00 Praha 10, Czech Republic  
VAT no: CZ26726548

**The product is inline with directives and regulations listed below:**

Directive MD 2006/42/EC  
Directive EMC 2014/30/EU  
Directive NEE 2000/14/EC  
Directive RoHS 2011/65/EU

**and norms:**

EN 62841-1:2015+AC  
EN 62841-2-11:2016  
EN 55014-1:2017  
EN 55014-2:2015  
EN 61000-3-2:2014  
EN 61000-3-3:2013



**Place of issuance:** Prague

**Name:** Ing. Zdeněk Pech  
Chairman of the Board

**Date of issuance:** 23. 11. 2020

**Signature:**

**FAST** FAST ČR, a.s. ©  
Černokostecká 1621, 251 01 Říčany  
IČO: 26726548 tel.: +420/ 323 204 111  
DIČ: CZ26726548 fax: +420/ 323 204 110



IČO: 26 72 65 48, DIČ: CZ-26 72 65 48

**Bankovní spojení:** Komerční banka Praha 1, č.ú. 89309011/0100, Česká spořitelna Praha 4, č.ú. 2375682/0800,  
ČSOB Praha 1, č.ú. 8010-0116233383/0300

## 11. TECHNICAL SPECIFICATIONS

|                              |               |
|------------------------------|---------------|
| Power supply .....           | 230V~ / 50Hz  |
| Power input .....            | 800 W         |
| Speed .....                  | 0-2800 rpm    |
| Cutting depth in wood .....  | 80 mm         |
| Cutting depth in steel ..... | 10 mm         |
| Pendulum positions .....     | 0, I, II, III |
| Bevel angle .....            | 0°- 45°       |

Instructions Manual - language version only.

## 12. DISPOSAL

### **INSTRUCTIONS AND INFORMATION ON DISPOSAL OF USED PACKAGING.**

Put any used package material to the place determined by the municipality for waste disposal.

### **DISPOSAL OF USED ELECTRIC AND ELECTRONIC EQUIPMENT**



This symbol on products or accompanying documents means that used electric or electronic products must not be put to ordinary municipal waste. Hand over such products to determined collection points for proper disposal, restoration and recycling. Alternatively, in some countries of the European Union or other European countries you can return your products to your local dealer when you buy an equivalent new product. By dutiful disposal of this product you can preserve precious natural resources and you help prevent any potential adverse effects on the environment and human health which could be the results of wrong waste disposal. Ask your local authority or the nearest collection point for additional details. In case of improper disposal of this waste kind penalties can be imposed in accordance with national regulations.

#### **For companies in the European Union countries**

Should you want to dispose of electric and electronic devices, ask your dealer or vendor for necessary information. Disposal in other countries outside the European Union. Should you want to dispose of this product, ask your local authorities or your dealer for necessary information about disposal method.



This product fulfils all basic requirements of the EU directives that apply to it.

Text, design and technical specifications can change without prior notice and we reserve the right for their change.

