



FIELDMANN[®]
Home & Garden Performance

20V L-HON
FASTPOWER



FDUV 70105-0

English	5-20
Čeština.....	21-38
Slovenčina	39-56
Magyarul	57-72
Polski	73-89

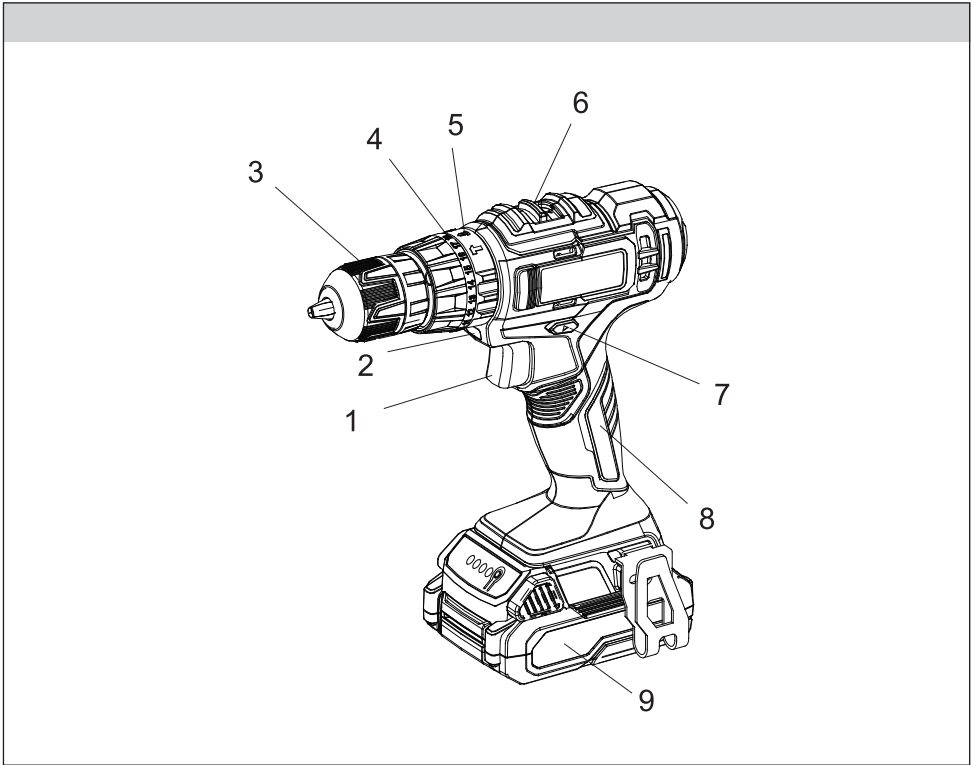

1

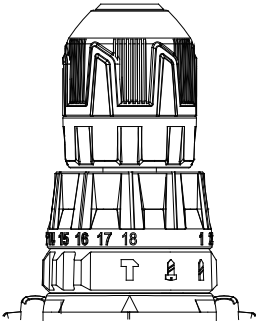

2

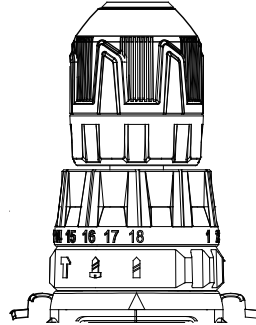

3

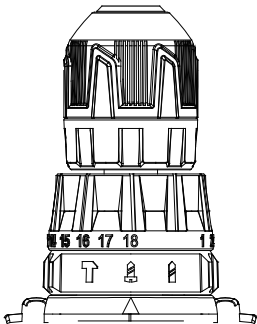

4

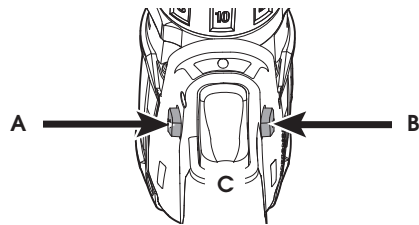

Cordless Drill **20V** FAST-POWER

USER'S MANUAL

Thank you for purchasing this Cordless Drill. Before you start using it, please carefully read this user's manual and save it for possible future use.

CONTENTS



1. GENERAL SAFETY INSTRUCTIONS.....	6
2. SYMBOLS	7
3. PRODUCT DESCRIPTION AND SPECIFICATIONS	8
4. OPERATION.....	8
5. APPLICATIONS.....	11
6. OPERATING INSTRUCTIONS.....	12
7. MAINTENANCE AND STORAGE.....	15
8. TECHNICAL DATA	17
9. TROUBLESHOOTING.....	18
10. DISPOSAL	19
11. DECLARATION OF CONFORMITY	20

1. GENERAL SAFETY INSTRUCTIONS

WARNING!

Carefully read the instruction manual before use.

Important safety warnings

-  Unpack the product carefully and be sure not to throw away any part of the package before having found all components of the product.
-  Keep the product in a dry place out of reach of children.
-  Read all cautions and instructions. The failure to adhere to warning cautions and instructions may result in an accident, fire and/or a serious injury.

Packaging

The product is placed in a package preventing damage during transport. This package is a raw material therefore it can be handed-over for recycling.

Instructions for use

Before beginning to work with the machine, read the following safety rules and instructions for use. Familiarize with operating elements and the proper use of the device. Keep the manual in a safe place for future reference. We recommend keeping the original package including the inner packaging materials, cash voucher and guarantee card for a period of warranty at minimum.

For a case of transportation, pack the machine into the original box from the manufacturer, thus ensuring a maximum protection of the product during a possible transport (e.g. moving or sending into a service station).

Note:

If you hand the machine over to next persons, hand it over together with the manual. Adherence to the attached instructions for use is a precondition for the proper use of the machine. The operation manual includes also instructions for operation, maintenance and repairs.

The manufacturer does not take any responsibility for accidents or damages resulting from the failure to adhere to this manual.

2. SYMBOLS



The product complies with the applicable standards and regulations.



Read the Instruction Manual attentively prior to use.



Use eyes protective equipment



Use ears protective equipment

3. PRODUCT DESCRIPTION AND SPECIFICATIONS

1. Trigger
2. LED
3. Keyless chuck
4. Torque selector collar
5. Application selector collar (01A-18Li only)
6. Speed selector
7. Control switch
8. Handle
9. Battery (not included)

4. OPERATION

WARNING!

Always remove battery pack before changing or removing accessories. Only use accessories specifically recommended for this tool. Others may be hazardous. To reduce the risk of injury, always wear safety goggles or glasses with side shields.

Installing Bits

Always remove the battery before inserting or removing bits. Select the proper style and size bit for the job. This tool is equipped with a spindle lock. The chuck can be tightened with one hand, creating higher grip strengths on the bit.

1. To open the chuck jaws, turn the sleeve in the counterclockwise direction. When using drill bits, allow the bit to strike the bottom of the chuck. Center the bit in the chuck jaws and lift it about 1/16" off of the bottom. When using screwdriver bits, insert the bit far enough for the chuck jaws to grip the hex of the bit.
2. To close the chuck jaws, turn the sleeve in the clockwise direction. The bit is secure when the chuck makes a ratcheting sound and the sleeve can not be rotated any further.
3. To remove the bit, turn the sleeve in the counterclockwise direction.

Note:

A ratcheting sound may be heard when the chuck is opened or closed. This noise is part of the locking feature, and does not indicate a problem with the chuck's operation.

Selecting Hammer, Drill or Drive Action

1. **To use the hammer-drilling mode**, rotate the application selector collar until the hammer symbol  appears in line with the arrow. Apply pressure to the bit to engage the hammering mechanism. (Fig. 1)

Note:

The number selected on the torque selector collar has no effect on operation of the drill in hammer mode.

 **Note:**

When using carbide bits, do not use water to settle dust. Do not attempt to drill through steel reinforcing rods. This will damage the carbide bits.

2. **To use the drilling only mode**, rotate the application selector collar until the drill symbol  appears in line with the arrow. (Fig. 2)

 **Note:**

The number selected on the torque selector collar has no effect on operation of the drill in drilling mode.

3. **To use the driving screws mode** rotate the application selector collar until the drive symbol  appears in line with the arrow. Then rotate the torque selector collar until the desired clutch setting appears in line with the arrow. The adjustable clutch, when properly adjusted, will slip at a preset torque to prevent driving the screw too deep into different materials and to prevent damage to the screw or tool. The torque specifications shown here are approximate values obtained with a fully charged battery pack. (Fig. 3)

Clutch Setting	Applications
1-3	Small screws in softwood.
4-6	
7-9	Medium screws in softwood or small screws in hardwood.
10-13	
14-17	Large screws in softwoods. Medium screws in hardwood or large screws in hardwood with pilot hole.
18	

 **Note:**

Because the settings shown in the table are only a guide, use a piece of scrap material to test the different clutch settings before driving screws into the workpiece.

Selecting Speed

The speed selector is on top of the motor housing. Allow the tool to come to a complete stop before changing speeds. See "Applications" for recommended speeds under various conditions.

1. For **Low** speed, push the speed selector to display "1".
2. For **High** speed, push the speed selector to display "2".

Using the Control Switch

The control switch may be set to three positions: forward, reverse and lock. Due to a lockout mechanism, the control switch can only be adjusted when the ON/OFF switch is not pressed. Always allow the motor to come to a complete stop before using the control switch.

For **forward** (clockwise) rotation, push in the control switch from the right side of the tool. **Check the direction of rotation before use.** (Fig. 4, A - Forward, B - Reverse, C - Lock Push to CENTER)

For **reverse** (counterclockwise) rotation, push in the control switch from the left side of the tool. **Check the direction of rotation before use.**

To **lock** the trigger, push the control switch to the center position. The trigger will not work while the control switch is in the center locked position. Always lock the trigger or remove the battery pack before performing maintenance, changing accessories, storing the tool and any time the tool is not in use.

WARNING!

To reduce the risk of injury, always hold or brace securely.

Starting, Stopping and Controlling Speed

1. To **start** the tool, grasp the handles firmly and pull the trigger.

Note:

An LED is turned on when the trigger is pulled.

2. To **vary** the speed, increase or decrease the pressure on the trigger. The further the trigger is pulled, the greater the speed.
3. To **stop** the tool, release the trigger. Make sure the bit comes to a complete stop before laying the tool down.

Drilling

Place the bit on the work surface and apply firm pressure before starting. Too much pressure will slow the bit and reduce drilling efficiency. Too little pressure will cause the bit to slide over the work area and dull the point of the bit. If the tool begins to stall, reduce pressure slightly to allow the bit to regain speed. If the bit binds, reverse the motor to free the bit from the workpiece.

5. APPLICATIONS

WARNING!

To reduce the risk of electric shock, check work area for hidden pipes and wires before drilling or driving screws.

Drilling in Wood, Composition Materials and Plastic

When drilling in wood, composition materials and plastic, select the  drill-only operating mode. Start the drill slowly, gradually increasing speed as you drill. When drilling into wood, use wood augers or twist drill bits. Always use sharp bits. When using twist drill bits, pull the bit out of the hole frequently to clear chips from the bit flutes. To reduce the chance of splintering, back work with a piece of scrap wood. Select low speeds for plastics with a low melting point.

Drilling in Metal

When drilling in metal, select the  drill-only operating mode. Use high speed steel twist drills or hole saws. Use a center punch to start the hole. Lubricate drill bits with cutting oil when drilling in iron or steel. Use a coolant when drilling in nonferrous metals such as copper, brass or aluminum. Back the material to prevent binding and distortion on breakthrough.

Drilling in Masonry

When drilling in masonry, select the  hammer drill operating mode. Use high speed carbide-tipped bits. Drilling soft masonry materials such as cinder block requires little pressure. Hard materials like concrete require more pressure. A smooth, even flow of dust indicates the proper drilling rate. Do not let the bit spin in the hole without cutting. Do not use water to settle dust or to cool bit. Both actions will damage the carbide.

Driving Screws and Nut Running

Drill a pilot hole when driving screws into thick or hard materials. Select the  driving screws mode. Set the torque selector collar to the proper position and set the speed to low. Use the proper style and size screwdriver bit for the type of screw you are using. With the screwdriver bit in the screw, place the tip of the screw on the workpiece and apply firm pressure before pulling the trigger. Screws can be removed by reversing the motor.

Overloading

Continuous overloading may cause permanent damage to tool or battery pack.

6. OPERATING INSTRUCTIONS

Operation

- ✿ This product must not be used by children and persons with physical or mental impairments or by inexperienced persons, unless properly trained or schooled in the safe use of the product, or unless they have been properly supervised by a qualified person who will be responsible for their safety.
- ✿ Use extra care if the product is used near children. Always keep the appliance out of reach of children. Children must be supervised to ensure that they do not play with the product.
- ✿ Never allow children or persons who do not know the contents of this user's manual to work with the device. Local regulations may set the minimum age of the user. The user is responsible for damages caused to third parties in the machine's working area as a result of its use.
- ✿ Do not use the machine if you are tired, under the influence of alcohol or narcotics.
- ✿ If necessary, use personal protection aids (gloves, work footwear, eye protection, respirators, etc.). Personal protection aids reduce the risk of injury to persons.
- ✿ Dress appropriately. Do not wear loose clothing or jewellery and make sure that your hair, clothing or gloves do not come dangerously close to moving parts. Loose clothing, jewellery or long hair may become caught in the moving parts.
- ✿ Pay constant attention, watch what you are doing and think when working with power tools. Do not use power tools if you are tired or under the influence of drugs, alcohol or medication. A moment of carelessness when working with power tools may lead to serious injury.
- ✿ Prevent the situation where the tool is turned on accidentally. Ensure the trigger switch is in the Off position before connecting the power cord to the power socket. Carrying power tools with the finger on the main trigger switch or connecting the power cord to the power socket when the main trigger switch is in the On position may cause injury.
- ✿ Do not get in your own way. When working, always maintain a firm posture and balance. This will make it possible to better control the power tool in unexpected situations.
- ✿ Use clamps or a vice to fasten the workpiece. It is safer than holding the workpiece in your hand and at the same time you have both hands free to operate the tool.
- ✿ Keep the working area tidy and well illuminated. A cluttered and badly lit work area may lead to injury.
- ✿ Do not work with the power tool in an explosive environment, such as for example areas where there are flammable liquid, gas or powder substances. Sparks are made inside the power tool, which may cause the ignition of flammable powder or vapour.
- ✿ Do not work with materials containing asbestos. Use a dust mask. When working with the tool ensure there is a safe distance from children and other persons. Distractions may lead to a loss of control over the tool.

Purpose of use

- ✿ This tool is not designed for professional use.
- ✿ Do not use the product for purposes other than those intended.
- ✿ For safety reasons the machine must not be used as a drive engine for any other work tools and tool sets, unless expressly permitted by the manufacturer.

Instructions for use

- ✿ Turn on and operate the machine as described in the user's manual, carefully follow all instructions.
- ✿ Before carrying out any kind of inspection, maintenance or repairs disconnect the charger power cable from the mains power supply.

- ✿ Use tools in good working condition for tasks for which they are designed.
- ✿ Work only during good visibility or ensure sufficient artificial lighting.
- ✿ Work in a clean and tidy working environment.
- ✿ Make sure that while working you maintain a firm and stable stance. Do not forget that falls represent one of the major causes of injuries during accidents.
- ✿ When drilling metal sheets use a vice and place a piece of wood underneath the sheet. A rotating metal sheet presents a serious risk.
- ✿ Make sure that the drill or screwdriver are not used for work on items under live current, to prevent injury by electrical shock. Before using this tool, check that you know the location of all electrical conductors or cables in the wall (use a metal detector for this purpose).
- ✿ Only store and use the product away from flammable or volatile materials and solutions.
- ✿ Keep the product away from extreme temperatures, direct sunlight and excessive humidity. Do not use in a dusty environment.
- ✿ Do not place the product near heaters, open fires or other appliances or equipment that are sources of heat.
- ✿ Do not spray the product with water or any other liquid. Do not pour water or any other liquids into the appliance. Do not submerge the appliance in water or any other liquid.
- ✿ Never leave the appliance switched on without supervision.
- ✿ Do not touch machine parts until they have come to a complete stop.
- ✿ Allow the motor to cool down before storing the machine in a closed room.
- ✿ Under no circumstances should you repair or alter the product yourself. Entrust all repairs and adjustments of this product to an authorised service centre or the vendor. Tampering with the appliance during the warranty period may void the warranty.
- ✿ The manufacturer is not responsible for damages caused by incorrect use of this product or its accessories. Such damages include food spoilage, injuries, burns, scalding, fire, etc.

Electrical safety

ATTENTION!

Read all the safety warnings and all instructions. If you fail to follow the provided warnings and instructions an injury caused by electrical shock could occur as well as fire or serious injuries.

Note:

Keep these warnings and instructions for future use. The term “electric power tool” in all warnings relates to your tool powered from the mains (it has a power cord installed) or cordless tools (without a power cord).

- ✿ The charger of the cordless device can be connected to any power plug, preventing discharge, that is installed according to norms in force.
- ✿ The plug must be powered at 230V ~ 50Hz.
- ✿ Disconnect the charger if you will not be using it for a long time, if you are changing the tool or performing maintenance on the tool.
- ✿ The power plug on the tool’s charger cord must correspond to the power socket. Never modify the power plug in any way. Do not use any power plug adapters for tools protected by grounding. Unmodified power plugs and corresponding power sockets reduce the risk of injury by electrical shock.
- ✿ Do not touch grounded surfaces such as pipes, heaters, electrical stoves and refrigerators when working with the machine. When your body is grounded the risk of injury by electrical shock is increased.

- ✿ Do not expose the electrical tool to rain or a moist environment. The entry of water into the electrical tool increases the risk of injury by electrical shock.
- ✿ Handle the power cord with care. Never use the power cord to carry or move the tool and do not pull on it when you want to disconnect the tool from the power grid. Prevent the tool coming into contact with greasy, hot and sharp items or moving parts. A damaged or tangled up power cord increases the risk of injury by electrical shock.
- ✿ When working with electric power tools in a moist environment, the power circuit must have current protection installed (RSD - Residual Current Device). The use of a residual current device reduces the risk of injury by electrical shock.

Safety instructions for the battery and charger

- ✿ Use only the battery and charger supplied with this tool.
- ✿ Connect the charger only to a mains power socket with a voltage of 230V.
- ✿ Protect the battery and charger from moisture. Do not use the device in an outdoor environment.
- ✿ Disconnect the charger from the mains power socket when the charger is not being used, before cleaning the charger or before performing repairs on it.
- ✿ Take special care of the battery. Prevent the battery from falling on to a hard surface and do not expose the battery to the effects of pressure or other excessive mechanical stress. Keep the battery at a safe distance from excessive heat or cold.
- ✿ Do not attempt to repair or disassemble the battery or the charger. If any part is damaged, have it repaired by a qualified technician or send it for repair to an authorised service centre or the vendor.
- ✿ Charge the battery only when the ambient air temperature is between 10°C and 40°C. A charged battery may be used to power tools in operating conditions at a temperature between 0°C and 50°C. If the battery is not being used store it in a dry place at a temperature between 10°C and 30°C.

IMPORTANT! DANGER!

Never short circuit the battery contacts and do not expose the battery to moisture. Do not store the battery together with metal items and parts, which could cause a short circuit of the battery contacts. The battery could overheat, catch on fire or explode.

- ✿ If any person comes into contact with the electrolyte or another liquid or substance found in the battery, they must immediately wash this substance away with large amounts of water. If these substances come into contact with eyes, flush the eyes out with large amounts of water and immediately seek medical treatment.
- ✿ Do not throw rechargeable batteries into a fire or into water. Otherwise an explosion could occur. A rechargeable battery should not be thrown out with ordinary household waste, regardless of the fact whether it has or has not been used. In accordance with valid regulations you should take the battery to a collection point or put it into the container labelled "Used Batteries" in our store.
- ✿ Only charge the battery in a charger designated by the manufacturer. A charger appropriate for one type of battery creates a fire hazard when used with another type of battery.
- ✿ Only use the electric power tool with a battery intended to be used in it. The use of different batteries may lead to a risk of injury or a fire hazard.
- ✿ If you are not using the battery, store it away from metal items, such as paper clips, coins, keys, nails, screws or other small items, which could lead to the short circuit of the battery contacts. Short circuiting the battery contacts may cause burns or a fire.

7. MAINTENANCE AND STORAGE

Maintenance

⚠ ATTENTION!

Disconnect the charger if you will not be using it for a long time, if you are changing the tool or performing maintenance on the tool.

- ✿ This tool does not require any special maintenance. The same applies to the electrical parts of the tool.
- ✿ Check whether the device is showing signs of wear.
- ✿ If the charger is damaged (cover, conductors or connector), immediately arrange its replacement at the vendors service centre.
- ✿ Regular care for the machine will ensure not only a long lifetime and performance.
- ✿ Before use always visually check for worn or damaged parts.
- ✿ Replace damaged or worn parts. To ensure that the machine always remains balanced, always replace the entire set of the worn or damaged tools.
- ✿ Worn or damaged machine parts may only be replaced at an authorised service centre or the vendor.
- ✿ Before cleaning disconnect this product from the power source.
- ✿ To clean the plastic parts of the product, use a soft cloth dipped in lukewarm water. Do not use aggressive cleaning products and solvents as this could damage the surface of the appliance.
- ✿ Do not clean the machine under running water or submerge under water.
- ✿ After changing the working tool, check that the working tool is secured in its storage position.
- ✿ Do not use working tools that are not proportioned for placement into the tang in the magazine.
- ✿ Do not overload the electric power tool. Use the right type of electric power tool for your work. When the correct electric power tool is used, the work result will be performed better and more safety.
- ✿ If it is not possible to turn the main trigger switch on or off, do not work with the tool. All electric power tools with a trigger switch that do not work are dangerous and must be repaired.
- ✿ If you are not working with the tool, store it out of the reach of children and prevent persons not informed about the operation of the tool or this user's manual to work with the tool. An electric power tool in the hands of an unqualified person is dangerous.
- ✿ Perform maintenance on the tool. Check for deviation or blockage of the moving parts, damage of individual parts and other factors which could affect the operation of the tool. If the tool is damaged, have it repaired before using it. Many accidents are caused by neglected maintenance of a tool. Properly maintained cutting tools with sharp cutting edges are less prone to jamming in a workpiece and are easier to handle.
- ✿ Maintain cutting tools sharp and clean. Properly maintained cutting tools with sharp cutting edges are less prone to jamming in a workpiece and are easier to handle.
- ✿ Use electric power tools, accessories, working tools, etc. according to these instructions in a manner appropriate for the given type of electric power tool and take into consideration the work conditions and the type of work that you will be performing. Using electric power tools for purposes other than those for which they were designed may be dangerous.
- ✿ Damaged switches must be replaced at an authorised service centre or the vendor. Do not use electric power tools that cannot be turn on and off.
- ✿ Do not leave electric power tools turned on without supervision. Always turn the tool off and wait for it to come to a complete stop before putting it down.
- ✿ Use hearing protection. Excessive noise levels may cause hearing damage.

- ✿ When performing tasks, where the working tools may come into contact with hidden electrical conductors, hold the electric power tool by the insulated part that is intended to be held. A work tool that comes into contact with a "live" electrical conductor, will cause the uninsulated parts of the tool to become live and may subsequently cause injury by electrical shock to the operator.
- ✿ For repairs contact an authorised service centre or vendor who will use original spare parts. This will ensure the correct operation of the electric power tool.

⚠ ATTENTION!

Using any accessories or tools not recommended in this user's manual may increase the risk of injury. Always use only original spare parts.

- ✿ Clean the tool after the completion of every work task.
- ✿ Do not use worn or damaged drill bits and drilling extension pieces. Such tools may overload the motor and lower effectiveness.
- ✿ Take proper care to prevent the motor from damage by oil or water.
- ✿ Regularly check that the tool has not been damaged during the course of standard operation. Make sure that all parts are correctly connected and do not use this product if any of its parts has been damaged or lost.
- ✿ When inserting the battery into the charger, ensure that the battery is inserted in the correct manner and that there are no materials between the battery contacts, e.g. soils.
- ✿ The battery and the charger should be protected from heat and the sun. Do not expose these products to extreme temperatures.
- ✿ Do not use the device in an outdoor environment.
- ✿ Use only the charger supplied with this tool.
- ✿ If the product is damaged or malfunctions, contact an authorised service centre or the vendor.

Storage

- ✿ Store the tool in a dry location at a sufficient distance from heat sources or dangerous vapours.
- ✿ Do not place any other items on the machine.

8. TECHNICAL DATA

Model	FDUV 70105-0
Rated voltage	20 V
Unloaded Speed	0-360 / 0-1300 RPM
Max torque	35 Nm
Max. diameter	10 mm
Impact function	yes
Keyless chuck	yes
LED light	yes
Torque	18 + 3 clutch setting

Accessories

Item number	Accessory
FDUZ 79020	Battery pack 2 Ah
FDUZ 79040	Battery pack 4 Ah
FDUZ 79100	Fast charger
FDUZ 79110	Fast dual charger
FDV 9004	Sets of drills/bits
FDV 9006	Sets of drills/bits
FDV 9101	Sets of drills/bits
FDV 9201	Sets of drills/bits
FDV 9202	Sets of drills/bits
FDS 9002-9007	Sets of bits

9. TROUBLESHOOTING

Suspected malfunctions are often due to causes the user can fix themselves. Therefore check the product using this section. In most cases the problem can be solved quickly.

⚠ WARNING!

Only perform the steps described within these instructions! All further inspection, maintenance and repair work must be performed by an authorized service centre or a similarly qualified specialist if you cannot solve the problem yourself!

Problem	Possible Cause	Solution
1. Product does not start	1.1 Not connected to power supply 1.2 Power cord or plug is defective 1.3 Other electrical defect to the product	1.1 Connect to power supply 1.2 Check by a specialist electrician 1.3 Check by a specialist electrician
2. Product does not reach full power	2.1 Extension cord is not suitable for operation with this product. 2.2 Power source e.g. generator has too low voltage 2.3 Air vents are blocked	2.1 Use a proper extension cord 2.2 Connect to another power source
3. Unsatisfactory result	3.1 Drill is dull/damaged 3.2 Drill bit is not suitable for work piece material	3.1 Replace with new one 3.2 Use proper Drill
4. Excessive vibration or noise	4.1 Drill bit is dull/damaged	4.1 Replace with a new one

10. DISPOSAL



The machine, rechargeable batteries, accessories and packaging should be sorted for environmentalfriendly recycling.

Do not dispose of power tools and batteries/rechargeable batteries into household waste!

Only for EC countries:



According to the European Guideline 2012/19/EU, power tools that are no longer usable, and according to the European Guideline 2006/66/EC, defective or used battery packs/batteries, must be collected separately and disposed of in an environmentally correct manner.

INSTRUCTIONS AND INFORMATION ON DISPOSING OF USED PACKAGING MATERIALS

Put any used package material to the place determined by the municipality for waste disposal.

DISPOSAL OF USED ELECTRIC AND ELECTRONIC EQUIPMENT



This symbol on products or accompanying documents means that used electric or electronic products must not be put to ordinary municipal waste. Hand over such products to determined collection points for proper disposal, restoration and recycling. Alternatively, in some countries of the European Union or other European countries you can return your products to your local dealer when you buy an equivalent new product. By dutiful disposal of this product you can preserve precious natural resources and you help prevent any potential adverse effects on the environment and human health which could be the results of wrong waste disposal. Ask your local authority or the nearest collection point for additional details. In case of improper disposal of this waste kind penalties can be imposed in accordance with national regulations.

For companies in the European Union countries

Should you want to dispose of electric and electronic devices, ask your dealer or vendor for necessary information. Disposal in other countries outside the European Union. Should you want to dispose of this product, ask your local authorities or your dealer for necessary information about disposal method.



This product fulfils all basic requirements of the EU directives that apply to it.

Text, design and technical specifications can change without prior notice and we reserve the right for their change.

User manual in the original language.

11. DECLARATION OF CONFORMITY

FAST®

FAST ČR, a.s.
Černokostecká 1621, 251 01 Říčany, Czech Republic
tel.: +420 323 204 111, fax: +420 323 204 110

EU DECLARATION OF CONFORMITY

Product / brand: Cordless Drill / **FIELDMANN**

Type / model: **FDUV 70105-0** as factory model JOZ-WYT01A-18Li
DC 20V (battery powered), speed 0-1300/m¹, diameter 10mm,
Class III, IPX0
L_{PA} = 90dB(A), L_{WA} = 101dB(A)

Manufacturer: FAST ČR, a.s.
Černokostecká 2111, 100 00 Praha 10, Czech Republic
VAT no: CZ26726548

The product is inline with directives and regulations listed below:

Directive MD 2006/42/EC
Directive EMC 2014/30/EU
Directive NEOF 2000/14/EC
Directive RoHS 2011/65/EU

and norms:

EN 62841-1:2015
EN 62841-2-1:2018+A11
EN 55014-1:2017
EN 55014-2:2015



Place of issuance: Prague

Name: Ing. Zdeněk Pech
Chairman of the Board

Date of issuance: 22. 7. 2020

Signature:

FAST® FAST ČR, a.s.®
Černokostecká 1621, 251 01 Říčany
IČO: 26726548 tel.: +420/ 323 204 111
DIČ: CZ26726548 fax: +420/ 323 204 110

IČO: 26 72 65 48, DIČ: CZ26 72 65 48

Bankovní spojení: Komerční banka Praha 1, č.ú. 89309011/0100, Česká spořitelna Praha 4, č.ú. 2375682/0800,
ČSOB Praha 1, č.ú. 8010-0116235383/0300